



DRAGSTER 800
DRAGSTER 800 RR
DRAGSTER 800 RR SCS
DRAGSTER 800 RC
DRAGSTER 800 RC SCS

USER'S MANUAL
MANUALE DELL'UTENTE

MV AGUSTA

**DRAGSTER
EVOOR**



Manuale di manutenzione
Versione Italiana



INDICE GENERALE

<i>cap.</i>	<i>Descrizione argomenti</i>	<i>pag.</i>
1	MANUTENZIONE	3
1.1.	Simbologia	3
1.2.	Tabelle di manutenzione e controllo	4
1.3.	Attrezzi e accessori in dotazione	14
1.4.	Tabella lubrificanti e liquidi	15
1.5.	Olio motore - Controllo livello	16
1.5.1.	Olio motore - Ripristino livello	17
1.6.	Liquido di raffreddamento - Controllo livello	19
1.6.1.	Liquido di raffreddamento - Ripristino livello	20
1.7.	Pastiglie freni - Controllo usura	22
1.8.	Fluido comando freni - Controllo livello	23
1.9.	Fluido comando frizione - Controllo livello	25
1.10.	Pneumatici - Controllo e sostituzione	26
1.11.	Catena - Controllo e lubrificazione	32
1.12.	Regime di minimo - Controllo	36
1.13.	Sistema controllo emissioni evaporative	37
1.14.	Sostituzioni - informazioni generali	38
1.14.1.	Fusibili - Sostituzione	38
1.14.2.	Faro anabbagliante - Sostituzione lampadina	42
1.14.3.	Faro abbagliante - Sostituzione lampadina	44
1.15.	Batteria	45
1.16.	Pulizia della motocicletta	47
1.17.	Periodo di sosta prolungata	49

<i>cap.</i>	<i>Descrizione argomenti</i>	<i>pag.</i>
2	GUASTI	50
2.1.	Posizione del connettore diagnostica	50
2.2.	Inconvenienti al motore	51
2.3.	Inconvenienti all'impianto elettrico	56
3	INFORMAZIONI TECNICHE	58
3.1.	Descrizione generale della motocicletta	58
3.1.1.	Impianto frenante (ABS)	60
3.1.2.	Lubrificazione motore	61
3.1.3.	Circuito di raffreddamento	62
3.1.4.	Circuito di alimentazione	63
3.2.	Dati tecnici	64
3.3.	Riferimento colori componenti sovrastrutture (Dragster 800 Rosso)	72
3.4.	Riferimento colori componenti sovrastrutture (Dragster RR / RR SCS MY20)	74
3.5.	Riferimento colori componenti sovrastrutture (Dragster RC / RC SCS MY20)	76
3.6.	Riferimento colori componenti telaio e ciclistica	78



1.1. Simbologia

Le parti di testo di particolare importanza, relative alla sicurezza della persona e all'integrità della motocicletta, sono evidenziate con i seguenti simboli:



Pericolo - Attenzione: la mancata o incompleta osservanza di queste prescrizioni può comportare pericolo grave per la propria incolumità e per quella di altre persone.



Cautela - Precauzione: la mancata o incompleta osservanza di queste prescrizioni può comportare un rischio di danni alla motocicletta.

Per indicare le persone autorizzate allo svolgimento delle operazioni di regolazione e/o manutenzione, esse sono contraddistinte dai seguenti simboli:



Informazioni sulle operazioni consentite al motociclista.



Informazioni sulle operazioni che devono essere svolte solo dal personale autorizzato.

Per evidenziare ulteriori informazioni vengono utilizzati i seguenti simboli:



Il simbolo  indica la necessità di utilizzare un attrezzo od un'attrezzatura specifica per il corretto svolgimento dell'operazione descritta.



Il simbolo “ § ” indica il rimando al capitolo identificato dal numero che lo segue.



1

1.2. Tabelle di manutenzione e controllo

Le operazioni di manutenzione e controllo più importanti e la loro frequenza sono riportate nelle specifiche tabelle. È indispensabile eseguire tali operazioni per mantenere la motocicletta efficiente e sicura.

Gli intervalli indicati nella tabella della manutenzione periodica e di lubrificazione devono venire considerati solo come una guida generale in condizioni di marcia normali. Potrebbe essere necessario ridurre tali intervalli in funzione delle condizioni climatiche, del terreno, della situazione geografica e dell'impiego individuale.

Alcune operazioni possono essere eseguite dal proprietario della motocicletta, purchè in possesso delle competenze necessarie. In caso contrario fare eseguire le operazioni presso un centro di assistenza autorizzato.

In generale le operazioni di manutenzione vanno eseguite con motocicletta posizionata su cavalletto posteriore, con motore spento e con interruttore in posizione "OFF". Durante il controllo del livello dei liquidi è invece preferibile tenere la moto in posizione verticale senza utilizzare il cavalletto posteriore.

Oltre i 105.000 Km (63000 mi), le operazioni devono essere eseguite con la stessa frequenza indicata nelle specifiche tabelle.



ATTENZIONE

- Una manutenzione impropria, o la mancata esecuzione dei lavori di manutenzione consigliati, aumenta il rischio di incidenti o di danneggiamenti della moto.
- Utilizzate sempre ricambi originali MV Agusta. L'utilizzo di ricambi non originali può accelerare l'usura della moto ed abbreviarne la durata.
- La mancata esecuzione delle operazioni raccomandate o l'utilizzo di ricambi non originali può comportare la non operabilità della garanzia.
- La sostituzione e/o il ripristino dei lubrificanti e dei liquidi va eseguita utilizzando esclusivamente i prodotti indicati nel §1.4.



ATTENZIONE

Nel caso di utilizzo in pista si raccomanda di far verificare la moto sia prima che dopo l'uso da personale specializzato appartenente alla rete dei Centri assistenza MV Agusta. L'utilizzo su pista è permesso solo occasionalmente e, comunque, non a scopi agonistici, anche se amatoriali.

L'uso della moto in pista comporta un sensibile incremento dell'usura delle varie componenti, con conseguente vita utile delle stesse ridotta rispetto ad un normale utilizzo su strada od autostrada.



Tabelle manutenzione programmata

(*): I tagliandi chilometrici possono essere effettuati congiuntamente con il tagliando annuale **obbligatorio**

Frequenza Manutenzione Km (mi)*		0	1000 (600)	Ogni anno	15000 (9000)	30000 (18000)	45000 (27000)	60000 (36000)	75000 (45000)	90000 (54000)	105000 (63000)
Tagliando		Con- segna	A	B	C	D	E	F	G	H	
DESCRIZIONE		OPERAZIONE									
Centralina elettronica		Verifica mappatura	•	•	•	•	•	•	•	•	•
Olio motore		Controllo / Ripristino livello	Prima di ogni utilizzo del veicolo								
		Controllo / Ripristino livello	•								
		Sostituzione	•	•	•	•	•	•	•	•	•
Filtro olio motore		Sostituzione (Utilizzare esclusivamente filtri olio originali MV Agusta)	Comunque ad ogni sostituzione olio motore								
Liquido di raffreddamento		Controllo / Ripristino livello	Prima di ogni utilizzo del veicolo								
		Controllo / Ripristino livello	•	•	•	•	•	•	•	•	•
		Sostituzione	Comunque ogni 2 anni								
Impianto raffreddamento		Controllo perdite	•	•	•	•	•	•	•	•	•
Elettroventola		Controllo funzionamento	•	•	•	•	•	•	•	•	•
Valvole		Controllo / Regolazione				•		•		•	
Catena distribuzione		Sostituzione									•



Tabelle manutenzione programmata

(*): I tagliandi chilometrici possono essere effettuati congiuntamente con il tagliando annuale **obbligatorio**

Frequenza Manutenzione Km (mi)*		0	1000 (600)	Ogni anno	15000 (9000)	30000 (18000)	45000 (27000)	60000 (36000)	75000 (45000)	90000 (54000)	105000 (63000)
Tagliando		Con- segna	A	B	C	D	E	F	G	H	
DESCRIZIONE		OPERAZIONE									
Pattino fisso distribuzione		Sostituzione									•
Pattino mobile distribuzione		Sostituzione									•
Tendicatena distribuzione		Sostituzione									•
Candele		Sostituzione				•		•		•	
Filtro benzina		Sostituzione				•		•		•	
Corpo farfallato		Controllo e pulizia condotti				•		•		•	
		Controllo sensore pressione				•		•		•	
Filtro aria (Anticipare interventi per guida in zone ad alto inquinamento)		Controllo / Sostituzione			•		•		•		•
		Sostituzione				•		•		•	
Cilindri		Controllo compressione				•		•		•	
		Controllo livello	Prima di ogni utilizzo del veicolo								
Fluido freni e frizione		Controllo livello	•	•	•	•	•	•	•	•	•
		Sostituzione	Comunque ogni 2 anni								



1

Tablelle manutenzione programmata

(*): I tagliandi chilometrici possono essere effettuati congiuntamente con il tagliando annuale **obbligatorio**





















Frequenza Manutenzione Km (mi)*		0	1000 (600)	Ogni anno	15000 (9000)	30000 (18000)	45000 (27000)	60000 (36000)	75000 (45000)	90000 (54000)	105000 (63000)
Tagliando		Con-segna	A	B	C	D	E	F	G	H	
DESCRIZIONE		OPERAZIONE									
Freni / Frizione		Controllo funzionalità	Prima di ogni utilizzo del veicolo								
		Controllo funzionalità e circuito	•	•	•	•	•	•	•	•	•
		Pulizia zona di contatto leva/pistoncino pompa		•	•	•	•	•	•	•	•
Parastrappi frizione 		Controllo / Sostituzione									•
Pastiglie freni (anteriore + posteriore)		Controllo usura	Ogni 1000 Km (600 mi)								
		Controllo / Sostituzione	•		•	•	•	•	•	•	•
Tubi circuito carburante		Controllo difetti e perdite		•	•	•	•	•	•	•	•
		Sostituzione	Comunque ogni 3 anni								
Comando acceleratore		Controllo funzionalità	Prima di ogni utilizzo del veicolo								
		Controllo funzionalità (tramite diagnosi TEXA)	•	•	•	•	•	•	•	•	•
Parastrappi corona		Controllo			•						
		Controllo/serraggio dado		•	•						
		Sostituzione				•	•	•	•	•	•



Tabelle manutenzione programmata

(*): I tagliandi chilometrici possono essere effettuati congiuntamente con il tagliando annuale **obbligatorio**

Frequenza Manutenzione Km (mi)*		0	1000 (600)	Ogni anno	15000 (9000)	30000 (18000)	45000 (27000)	60000 (36000)	75000 (45000)	90000 (54000)	105000 (63000)
Tagliando		Con- segna	A		B	C	D	E	F	G	H
DESCRIZIONE		OPERAZIONE									
Catena di trasmissione 		Ogni 1000 Km (600 mi)									
		Ogni 1000 Km (600 mi) e dopo ogni guida sotto la pioggia									
		●	●	●	Comunque ogni 1000 Km (600 mi)						
		Comunque ogni 1000 Km (600 mi)									
Pignone / Rosetta di fermo			●	●							
					●	●	●	●	●	●	●
Corona			●	●							
					●	●	●	●	●	●	●
Pneumatici		Ad ogni utilizzo del veicolo e comunque ogni 10 giorni									
		Ad ogni utilizzo del veicolo e comunque ogni 500 Km (300 mi)									
		●	●	●	●	●	●	●	●	●	●
			●	●	●	●	●	●	●	●	●



1

Tabelle manutenzione programmata

(*): I tagliandi chilometrici possono essere effettuati congiuntamente con il tagliando annuale **obbligatorio**











Frequenza Manutenzione Km (mi)*		0	1000 (600)	Ogni anno	15000 (9000)	30000 (18000)	45000 (27000)	60000 (36000)	75000 (45000)	90000 (54000)	105000 (63000)
Tagliando		Con- segna	A	B	C	D	E	F	G	H	
DESCRIZIONE		OPERAZIONE									
Cuscinetti di sterzo 		Controllo / Regolazione		•		•		•		•	
		Lubrificazione					•		•		•
Cerchi ruota		Controllo visivo	•	•	•	•	•	•	•	•	•
		Comunque ad ogni sostituzione dei pneumatici									
Raggi cerchi ruota (Dragster RR-SCS) 		Controllo / Serraggio		•	•	•	•	•	•	•	•
		Comunque ogni anno									
Cuscinetti ruota anteriore 		Controllo				•	•	•		•	•
		Comunque ad ogni sostituzione dei pneumatici									
Cavalletto laterale		Controllo funzionalità	Prima di ogni utilizzo del veicolo								
		Controllo funzionalità	•	•	•	•	•	•	•	•	•
Interruttore cavalletto laterale		Controllo funzionalità	Prima di ogni utilizzo del veicolo								
		Controllo funzionalità	•	•	•	•	•	•	•	•	•
Cuscinetti forcellone 		Controllo / lubrificazione						•			



Tabelle manutenzione programmata

(*): I tagliandi chilometrici possono essere effettuati congiuntamente con il tagliando annuale **obbligatorio**

Frequenza Manutenzione Km (mi)*		0	1000 (600)	Ogni anno	15000 (9000)	30000 (18000)	45000 (27000)	60000 (36000)	75000 (45000)	90000 (54000)	105000 (63000)
Tagliando		Con- segna	A		B	C	D	E	F	G	H
DESCRIZIONE		OPERAZIONE									
Mozzo ruota posteriore		Controllo / lubrificazione astuccio rullini			•	•		•	•		•
		Sostituzione					•			•	
Pattini catena forcellone		Controllo / sostituzione			•	•	•	•	•	•	•
Pattini catena piastra telaio		Controllo / sostituzione			•	•	•	•	•	•	•
Ammortizzatore posteriore		Controllo / regolazione	•	•	•	•	•	•	•	•	•
Forcelle anteriori		Controllo / regolazione	•	•	•	•	•	•	•	•	•
		Sostituzione olio					•		•		•
Sistema controllo emissioni evaporative		Controllo / sostituzione tubi, raccordi e canister				•	•	•	•	•	•
		Controllo / pulizia ingresso aria calda su canister				•	•	•	•	•	•
Collegamenti batteria		Controllo e pulizia			•	•	•	•	•	•	•
Impianto elettrico		Controllo funzionalità	•	•	•	•	•	•	•	•	•
Strumentazione		Controllo funzionalità	Prima di ogni utilizzo del veicolo								
		Controllo funzionalità	•	•	•	•	•	•	•	•	•



Tabelle manutenzione programmata

(*): I tagliandi chilometrici possono essere effettuati congiuntamente con il tagliando annuale **obbligatorio**

Frequenza Manutenzione Km (mi)*		0	1000 (600)	Ogni anno	15000 (9000)	30000 (18000)	45000 (27000)	60000 (36000)	75000 (45000)	90000 (54000)	105000 (63000)
Tagliando		Con- segna	A		B	C	D	E	F	G	H
DESCRIZIONE	OPERAZIONE										
Luci / segnali visivi	Controllo funzionalità	Prima di ogni utilizzo del veicolo									
	Controllo funzionalità / Sostituzione	•	•	•	•	•	•	•	•	•	•
Avisatore acustico	Controllo funzionalità	Prima di ogni utilizzo del veicolo									
	Controllo funzionalità	•	•	•	•	•	•	•	•	•	•
Fanale anteriore	Controllo funzionalità	Prima di ogni utilizzo del veicolo									
	Regolazione	Ad ogni variazione di assetto del veicolo									
Interruttore avviamento	Controllo funzionalità	Prima di ogni utilizzo del veicolo									
	Controllo funzionalità	•	•	•	•	•	•	•	•	•	•
Serrature	Controllo funzionalità	Prima di ogni utilizzo del veicolo									
	Controllo funzionalità	•	•	•	•	•	•	•	•	•	•
Serraggio viti e dadi	Controllo / serraggio	•	•	•	•	•	•	•	•	•	•
Fascette stringitubo	Controllo / serraggio	•	•	•	•	•	•	•	•	•	•
Lubrificazione generale		•	•	•	•	•	•	•	•	•	•
Collaudo generale		•	•	•	•	•	•	•	•	•	•



Tabelle manutenzione programmata

(**): Gli interventi chilometrici sulla frizione Dragster SCS non sono subordinabili al tagliando annuale **obbligatorio**

Frequenza Manutenzione Km (mi)**		0	1000 (600)	Ogni anno	15000 (9000)	30000 (18000)	45000 (27000)	60000 (36000)	75000 (45000)	90000 (54000)	105000 (63000)
Tagliando		Con- segna	A	B	C	D	E	F	G	H	
DESCRIZIONE		OPERAZIONE									
Freno di stazionamento (Dragster SCS)		Controllo funzionalità	Prima di ogni utilizzo del veicolo								
Frizione idraulica (Dragster SCS)		Controllo / regolazione gioco	•	•	•	•	•	•	•	•	•
Dischi frizione guarniti (Dragster SCS) **		Sostituzione			•	•	•	•	•	•	•
Disco espansore frizione (Dragster SCS) **		Controllo / Inversione del senso di montaggio			•		•		•		•
		Sostituzione				•		•		•	



1

1.3. Attrezzi e accessori in dotazione

Sotto la sella passeggero è possibile trovare i seguenti attrezzi:

- 2 chiavi a maschio esagonale (esagono da 2,5 mm - 4 mm);
- 1 chiave per eccentrico ruota posteriore e relativa prolunga;
- 1 estrattore per minifusibili.

All'interno della scatola portafusibili sono inoltre forniti i seguenti fusibili di scorta (vedi §1.13.1):

- 1 fusibile da 10A;
- 2 fusibili da 15A;
- 1 fusibile da 25A.



**1.4. Tabella lubrificanti e liquidi**

<i>Descrizione</i>	<i>Prodotto consigliato</i>	<i>Specifiche</i>
Olio lubrificazione motore	Motul 7100 4T 5W40 (*)	SAE 5W40
Liquido di raffreddamento	Motul Motocool Factory Line	Prodotto a base di glicole monoetilenico Pronto all'uso - Non diluire
Fluido comando frizione e freni	Motul DOT 3 & 4 Brake Fluid	DOT4
Olio lubrificazione catena	Motul Chain Lube Road	–

* : Per la reperibilità del prodotto consigliato, MV Agusta consiglia di rivolgersi direttamente ai propri concessionari autorizzati. Il motore del motociclo Dragster è stato sviluppato con olio motore Motul 7100 4T 5W40. Qualora il lubrificante descritto non fosse reperibile, MV Agusta consiglia l'utilizzo di olii completamente sintetici con caratteristiche conformi o superiori alle seguenti normative:

- Conforme API SN / SM
- Conforme JASO MA2
- Gradazione SAE 5W40

NOTA

Le specifiche sopra indicate devono essere riportate, da sole od insieme ad altre, sul contenitore dell'olio lubrificante.





1.5. Olio motore - Controllo livello

Eseguire il controllo a freddo, a motore spento. Se effettuato a caldo, il motore deve essere spento da almeno dieci minuti.

Questo controllo va effettuato disponendo la motocicletta su un piano orizzontale ed in posizione di marcia (posizione verticale).



ATTENZIONE: Questa operazione deve essere eseguita da due persone.

Svitare il tappo carico olio e rimuoverlo dalla propria sede. Pulire l'astina di controllo con un panno e riavvitare completamente il tappo nella propria sede, quindi rimuoverlo per eseguire la verifica del livello dell'olio.

Il livello deve essere compreso tra i riferimenti MAX e MIN sull'astina di controllo collegata al tappo.

Nel caso in cui il livello dell'olio si trovi sotto il riferimento MIN, effettuare un rabbocco (vedere 1.5.1).



Pericolo - Attenzione: Non avviare il motore se l'olio è sotto il riferimento MIN.

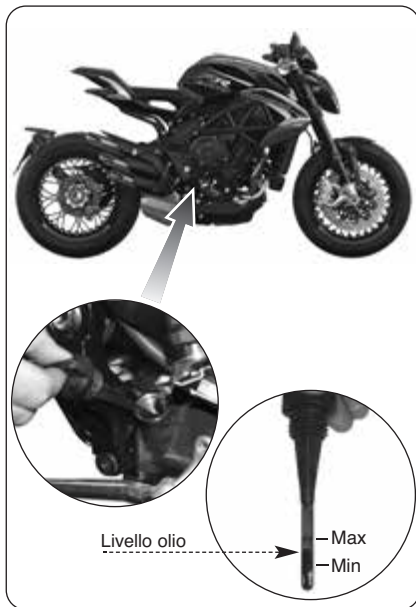



1.5.1. Olio motore - Ripristino livello

Svitare il tappo olio. Versare una quantità di olio del tipo consigliato fino a raggiungere un adeguato livello; in ogni caso non superare mai il riferimento MAX. Riavvitare il tappo al termine dell'operazione.



CAUTELA

Per prevenire slittamenti della frizione ed evitare il danneggiamento del motore, non miscelare additivi chimici all'olio, né utilizzare olii di tipo differente da quello riportato nel § 1.4. Accertarsi che non penetrino corpi estranei nel carter durante il rabbocco.





1

**ATTENZIONE**

L'olio motore, nuovo o esausto, può essere pericoloso. L'ingestione di olio motore, nuovo o esausto, può essere nociva per le persone e per gli animali domestici. In caso di ingestione di olio motore, chiamare immediatamente un medico e non provocare il vomito onde evitare aspirazione del prodotto nei polmoni. Si è constatato che il contatto continuo con l'olio motore provoca il cancro della pelle su cavie. Brevi contatti con l'olio motore possono irritare la pelle.

- Tenere l'olio motore, nuovo o esausto, lontano dalla portata dei bambini e degli animali domestici.
- Indossare indumenti con le maniche lunghe e guanti impermeabili all'acqua ogni volta che si effettua il rabbocco dell'olio motore.
- Lavarsi con acqua e sapone, se l'olio motore entra in contatto con la pelle.
- Riciclare o smaltire correttamente l'olio motore esausto.



1.6. Liquido di raffreddamento - Controllo livello

Eeguire il controllo a freddo e a motore spento. Questo controllo va effettuato disponendo la motocicletta su un piano orizzontale ed in posizione di marcia (posizione verticale).

Il livello deve trovarsi leggermente al di sopra del riferimento MIN presente sul serbatoio di espansione, come mostrato in figura.

Nel caso in cui il livello del liquido refrigerante si trovi sotto il riferimento MIN, effettuare un rabbocco (vedere § 1.6.1).



ATTENZIONE

Non utilizzare il motociclo se il livello del liquido di raffreddamento si trova al di sotto del riferimento MIN.



Livello
liquido



MIN



15



1

1.6.1. Liquido di raffreddamento - Ripristino livello

Svitare e rimuovere il tappo laterale del serbatoio di espansione. Tramite una siringa, effettuare il rabbocco utilizzando il fluido di raffreddamento consigliato nel § 1.4.



ATTENZIONE : Il rabbocco del liquido di raffreddamento va effettuato sempre a motore freddo. Non tentare mai di togliere il tappo del serbatoio del liquido di raffreddamento quando il motore è caldo per evitare il rischio di ustioni. Il circuito è in pressione!

Dopo il ripristino del livello, rimontare accuratamente le parti precedentemente smontate.



**ATTENZIONE**

In determinate condizioni il glicole etilenico contenuto nel liquido di raffreddamento è infiammabile e la sua fiamma è invisibile. Evitare di portare a contatto il liquido di raffreddamento con parti calde, in quanto la conseguente combustione del glicole etilenico potrebbe esporre al rischio di ustioni.

**ATTENZIONE**

Il liquido refrigerante del motore è nocivo se ingerito o se entra in contatto con gli occhi o con la pelle. Tenere il liquido refrigerante del motore lontano dalla portata dei bambini e degli animali domestici. In caso di ingestione di liquido refrigerante, chiamare immediatamente un medico e non provocare il vomito onde evitare aspirazione del prodotto nei polmoni. In caso di contatto del liquido refrigerante del motore con gli occhi o con la pelle, sciacquare immediatamente con acqua.



CAUTELA : Per il ripristino e/o la sostituzione del liquido di raffreddamento utilizzare esclusivamente il prodotto specificato in tabella § 1.4. Non miscelare né diluire il liquido di raffreddamento con additivi o fluidi differenti. Nel caso in cui il prodotto indicato al § 1.4. non fosse reperibile, utilizzare un prodotto avente analoghe caratteristiche tecniche.



CAUTELA : Gli spruzzi di refrigerante possono danneggiare le superfici verniciate. Stare attenti a non versare il fluido quando si riempie l'impianto di raffreddamento. Asciugare immediatamente con un panno pulito l'eventuale refrigerante del motore versato.



1

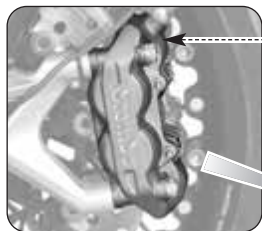

Pinza freno anteriore



Pinza freno posteriore

Disco freno

Pastiglia

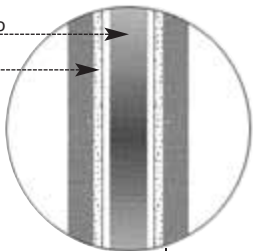

Limite di usura 1 mm



1.7. Pastiglie freni - Controllo usura

Controllare periodicamente l'altezza dello strato del materiale di attrito delle pastiglie, avendo cura di non scendere mai al di sotto del limite di usura minimo di 1 mm.

Pericolo - Attenzione: Utilizzando la moto con le pastiglie dei freni usurate, la potenza di frenata diminuisce ed aumenta il rischio di incidenti. Se lo spessore residuo è vicino al limite di usura, rivolgersi ad un centro di assistenza autorizzato per effettuare la sostituzione delle pastiglie. Sottoporre le nuove pastiglie ad opportuno rodaggio.



Serbatoio freno posteriore



Serbatoio freno anteriore



1.8. Fluido comando freni - Controllo livello



ATTENZIONE

Il mancato controllo ed una manutenzione carente dei freni aumentano il rischio di incidenti. Prima di ogni uscita con la moto, controllare il sistema frenante secondo le istruzioni di seguito riportate.

L'usura delle pastiglie dei freni provoca un normale calo del livello del fluido. In ogni caso il livello deve essere compreso tra i riferimenti MAX e MIN. Se tale livello scende al di sotto del riferimento MIN, occorre rivolgersi ad un centro assistenza autorizzato per un controllo generale dell'impianto frenante.

**1****ATTENZIONE**

Non utilizzare la motocicletta se il livello è al di sotto al riferimento MIN; in tale condizione l'impianto frenante potrebbe non funzionare correttamente, con conseguente rischio di perdita di controllo del veicolo ed incidenti. Se il livello del liquido si trova al di sotto del riferimento MIN, rivolgersi ad un concessionario MV Agusta per effettuare un controllo dell'impianto frenante.

**ATTENZIONE**

Fare effettuare il rabbocco del liquido dei freni esclusivamente da personale autorizzato. Il liquido dei freni è nocivo o mortale, se ingerito, ed è nocivo se viene a contatto della pelle e degli occhi. Tenete il liquido dei freni fuori dalla portata dei bambini e degli animali domestici. In caso di ingestione del liquido dei freni, chiamare immediatamente un medico e non provocare il vomito onde evitare aspirazione del prodotto nei polmoni. In caso di contatto del liquido dei freni con gli occhi o con la pelle, sciacquare immediatamente con acqua.

**ATTENZIONE**

Fare effettuare il rabbocco del liquido freni utilizzando solamente il tipo di fluido consigliato nel §1.4. del presente manuale. Eventuali miscele tra fluidi di tipo differente possono causare una reazione chimica pericolosa e la diminuzione dell'efficienza di frenata, con conseguente aumento del rischio di incidenti.

**ATTENZIONE**

Una quantità insufficiente di liquido freni può permettere la penetrazione di aria nell'impianto dei freni, compromettendo l'efficienza della frenata con conseguente aumento del rischio di incidenti. La presenza di aria nell'impianto idraulico potrebbe essere evidenziata nel caso in cui, premendo la leva del freno, si avvertisse una sensazione di eccessiva cedevolezza. In caso di presenza di aria nell'impianto idraulico, farne effettuare lo spurgo da un concessionario MV Agusta prima di utilizzare il mezzo.



1.9. Fluido comando frizione - Controllo livello

Il livello deve essere compreso tra i riferimenti MAX e MIN. Se tale livello scende al di sotto del riferimento MIN, occorre rivolgersi ad un centro assistenza autorizzato per un controllo generale dell'impianto comando frizione.



ATTENZIONE

Non utilizzare la motocicletta se il livello è al di sotto del riferimento MIN; in tale condizione l'impianto di comando frizione potrebbe non funzionare correttamente, con conseguente rischio di perdita di controllo del veicolo ed incidenti. Se il livello del liquido si trova al di sotto del riferimento MIN, rivolgersi ad un concessionario MV Agusta per effettuare un controllo dell'impianto frizione.



ATTENZIONE

Fare effettuare il rabbocco del liquido comando frizione utilizzando solamente il tipo di fluido consigliato nel §1.4. del presente manuale.



15



1

1.10. Pneumatici - Controllo e sostituzione



ATTENZIONE

Prima dell'uso verificare sempre la pressione dei pneumatici ed il loro stato di usura.

Il controllo della pressione dei pneumatici è un fattore fondamentale per assicurare la sicurezza di guida. I pneumatici non sufficientemente gonfi peggiorano la maneggevolezza della moto e si usurano rapidamente; al contrario pressioni di gonfiaggio troppo elevate determinano una minore superficie di contatto con il suolo e possono ridurre l'aderenza del veicolo.

Prima di ogni utilizzo della moto è perciò indispensabile eseguire il controllo della pressione con pneumatici a temperatura ambiente, cioè con la motocicletta parcheggiata da almeno tre ore.



ATTENZIONE

L'errato gonfiaggio dei pneumatici comporta seri pericoli nell'utilizzo della moto. Una pressione insufficiente può causare lo slittamento del pneumatico sul cerchione od il suo distacco, con conseguente afflosciamento del pneumatico e perdita di controllo del veicolo.



Effettuando il controllo subito dopo avere utilizzato la motocicletta, si otterrebbero infatti dei valori più alti rispetto a quelli effettivi e ciò potrebbe portare ad un'errata regolazione della pressione dei pneumatici. Il controllo della pressione va eseguito rispettando i valori riportati al §3.2. e/o nell'etichetta situata sul fodero della forcella anteriore destra. Nel caso di lunghe percorrenze continuative aumentare il valore della pressione nominale di 0,2 bar.

Inoltre, prima dell'uso è estremamente importante controllare lo stato di usura dei pneumatici; i pneumatici usurati tendono infatti a subire forature con maggiore facilità, ed influiscono negativamente sulla stabilità e la maneggevolezza della moto. Nel corso del controllo assicurarsi che lo spessore del battistrada non sia al di sotto dei valori prescritti dal codice della strada e che non compaiano crepe sul fondo della scolpitura. Inoltre non devono essere presenti chiodi o frammenti di vetro sul pneumatico, né fessurazioni sul fianco dello stesso. Se queste condizioni non fos-

sero verificate, fare sostituire immediatamente il pneumatico da un concessionario MV Agusta.

**ATTENZIONE**

I limiti di profondità del battistrada possono variare da nazione a nazione. Rispettare sempre le disposizioni di legge della nazione d'impiego.

**ATTENZIONE**

• Fare sostituire i pneumatici eccessivamente consumati da un concessionario MV Agusta. Oltre ad essere illegale, l'utilizzo del motociclo con pneumatici eccessivamente usurati riduce la stabilità di marcia e può provocare la perdita del controllo del mezzo.

• Se un pneumatico è forato o danneggiato va sostituito, non riparato. Un pneumatico riparato garantisce prestazioni limitate e livelli di sicurezza inferiori rispetto ad un pneumatico nuovo.



1

Se si esegue una riparazione temporanea o di emergenza ad un pneumatico, guidare lentamente e con cautela fino al più vicino concessionario MV Agusta e far sostituire il pneumatico. Dopo la riparazione di un pneumatico non eccedere mai la velocità di 60 km/h. La riparazione non può essere effettuata se il pneumatico è forato sul fianco, o se il foro sul battistrada è più grande di 6 mm.

- Per la riparazione temporanea di un pneumatico forato, MV Agusta sconsiglia l'utilizzo di sigillanti liquidi. Questi sigillanti possono influire negativamente sul materiale degli strati del pneumatico e nascondere i danni secondari causati da eventuale penetrazione di oggetti.

- Sostituire i pneumatici utilizzando esclusivamente quelli prescritti al § 3.2. Evitare inoltre di utilizzare simultaneamente pneumatici di tipo o marca differenti tra loro per le coperture anteriori e posteriori. L'utilizzo di pneumatici impropri può influire negativamente sulla manovrabilità e la stabilità della motocicletta, aumentando il rischio di incidenti.
- I cerchi della motocicletta sono stati progettati per l'utilizzo di pneumatici tubeless. Non installare pneumatici del tipo con camera d'aria su cerchi per pneumatici tubeless. I talloni potrebbero non assestarsi correttamente ed i pneumatici, slittando sui cerchi, potrebbero afflosciarsi causando la perdita di controllo del veicolo.



- Non installare una camera d'aria in un pneumatico tubeless. Il surriscaldamento del pneumatico potrebbe far scoppiare la camera d'aria, provocando l'afflosciamento del pneumatico e la perdita di controllo del veicolo.
- Fare installare i pneumatici in conformità alla direzione di rotazione indicata dalle frecce sui fianchi di ciascun pneumatico.

- I pneumatici nuovi devono essere sottoposti ad un periodo di rodaggio prima di raggiungere la completa efficienza; in questa fase è infatti possibile che i pneumatici abbiano una aderenza relativamente scarsa su determinate superfici stradali. Consigliamo quindi di guidare a velocità moderata ed usare estrema cautela nella guida per circa 100 km dopo l'installazione di un pneumatico nuovo.

1



1

□ Smontaggio della ruota posteriore



Cautela-Precauzione: Nel caso in cui si rendesse necessario far effettuare la sostituzione del pneumatico posteriore presso un gommista, assicurarsi che nello smontaggio e nel rimontaggio della ruota vengano utilizzati i seguenti utensili:

- Chiave a bussola poligonale da 55 mm
- Chiave dinamometrica

Se le suddette operazioni venissero effettuate con utensili differenti, i componenti della ruota posteriore potrebbero essere gravemente danneggiati. Consigliamo quindi di non fare effettuare la sostituzione del pneumatico presso un'officina non adeguatamente attrezzata; in ogni caso è preferibile rivolgersi ad un concessionario MV Agusta.

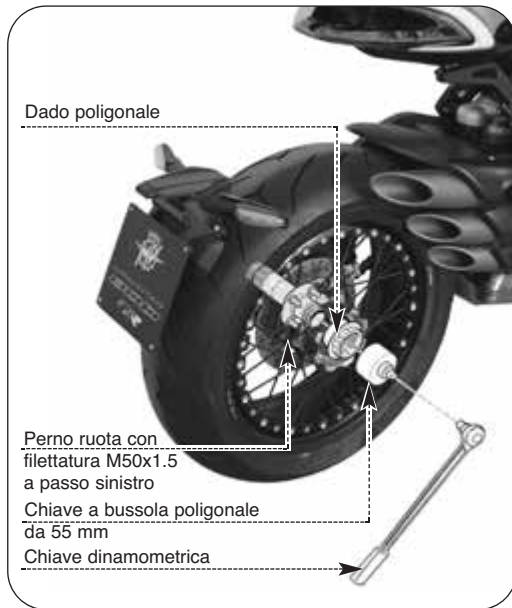



☐ Controllo delle ruote

Prima di utilizzare il mezzo, controllare sempre che il cerchio della ruota non presenti cricche, piegature o deformazioni.



ATTENZIONE

Se si riscontrano danneggiamenti, fare sostituire la ruota da un concessionario MV Agusta. Non tentare di eseguire riparazioni delle ruote, neppure di lieve entità.

In caso di sostituzione del pneumatico o della ruota, occorre fare eseguire l'equilibratura della ruota presso un concessionario MV Agusta. Lo sbilanciamento della ruota può compromettere la stabilità e la manovrabilità del mezzo e ridurre la durata dei pneumatici.



ATTENZIONE

Per eseguire l'equilibratura della ruote, ricorrere esclusivamente a contrappesi omologati. È sconsigliato l'utilizzo di bilancianti liquidi o di bilancianti liquidi/sigillanti.



ATTENZIONE

Non tentare di far rimuovere un pneumatico tubeless senza la speciale attrezzatura necessaria e le protezioni per il cerchio. In caso contrario, si rischia di danneggiare o deformare la superficie di tenuta del cerchio stesso, con conseguente rischio di afflosciamento del pneumatico e perdita di controllo del veicolo.



1

1.11. Catena - Controllo e lubrificazione

Per effettuare le seguenti operazioni posizionare la motocicletta sul cavalletto posteriore, su un piano orizzontale e con il cambio in folle.

□ Controllo della regolazione



ATTENZIONE: Prima di controllare la regolazione della catena, rivolgersi ad un centro assistenza autorizzato MV Agusta per verificare che il veicolo presenti la quota corretta dell'assetto statico della sospensione posteriore. Accertarsi inoltre che la catena sia adeguatamente lubrificata.

L'asse del ramo inferiore della catena deve trovarsi ad una distanza di **116 mm** dal paracatena inferiore. Effettuare il controllo su più punti della catena ruotando manualmente la ruota posteriore. Il gioco deve restare pressoché costante mentre la ruota gira; se la catena presenta forti oscillazioni del gioco, ciò significa che alcune maglie sono schiacciate, grippate o allungate. Se la distanza della catena dal paracatena inferiore è maggiore di 116 mm, occorre far effettuare la regolazione della catena.

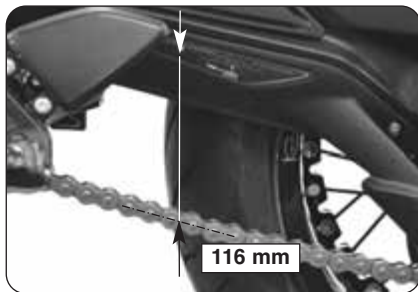



ATTENZIONE: L'uso della motocicletta con la catena in cattive condizioni o mal regolata può dar luogo ad incidenti. Prima di ogni uscita con la moto, effettuare il controllo della catena in conformità al presente capitolo. Nel caso in cui si rendesse necessaria la regolazione della tensione della catena, rivolgersi ad un centro assistenza autorizzato MV Agusta.



ATTENZIONE: Se la catena presenta maglie schiacciate, grippate o allungate, farne effettuare la sostituzione presso un centro assistenza autorizzato MV Agusta.



ATTENZIONE: Se si rilevano danni o usura eccessiva della catena o dei relativi ingranaggi, occorre rivolgersi ad un concessionario MV Agusta per la loro sostituzione. Ogni volta che si sostituisce la catena, anche i relativi ingranaggi devono essere rinnovati.

**ATTENZIONE**

Può essere pericoloso utilizzare una catena del tipo a falsamaglia. Una maglia principale non completamente rivettata, o del tipo a falsamaglia, può aprirsi e provocare incidenti o seri danni al motore. Non utilizzare mai catene con falsamaglia.

**ATTENZIONE**

Ogni volta che si renda necessario operare sulle viti del mozzo ruota posteriore, occorre rivolgersi ad un concessionario MV Agusta. Per il serraggio delle viti, rispettare il valore della coppia di serraggio indicata nella targhetta presente sul forcellone. Il superamento del valore indicato può causare il precoce deterioramento del mozzo ruota posteriore, compromettendo l'affidabilità del veicolo e la sicurezza del conducente e del passeggero.



1 □ Lubrificazione

La catena deve essere correttamente lubrificata per garantire la massima efficienza.

► Pulizia preliminare: prima di effettuare la lubrificazione è necessario disciogliere i depositi di sporco sulla catena utilizzando kerosene; tali depositi devono essere successivamente rimossi con un panno pulito e/o un getto d'aria.



Cautela - Precauzione: La catena è del tipo con anelli di tenuta (O-RING); per prevenirne il danneggiamento, non effettuare la pulizia della catena tramite getti di vapore o acqua ad alta pressione, né utilizzando benzina o solventi detergenti in commercio. La pulizia della catena va effettuata utilizzando esclusivamente kerosene.



ATTENZIONE

Il kerosene può essere pericoloso. Il kerosene è infiammabile. Il contatto con il kerosene può essere nocivo per i bambini e gli animali domestici.

Tenere le fiamme libere e gli oggetti ad elevata temperatura lontani dal kerosene. Tenere i bambini e gli animali domestici lontani dal kerosene. Effettuare correttamente lo smaltimento del kerosene usato.



► **Lubrificazione:** applicare un leggero ed uniforme strato di lubrificante sull'intero sviluppo della catena avendo cura di non raggiungere le parti circostanti, in particolare i pneumatici. Dirigere il getto dello spray sulla maglia interna, affinché possa lubrificare la superficie degli O-Ring e penetrare all'interno del rullo catena.



Cautela - Precauzione: Utilizzare solo il lubrificante riportato nel §1.4., allo scopo di proteggere efficacemente la catena di trasmissione ed evitare la formazione di schizzi durante la marcia del veicolo.



ATTENZIONE: La lubrificazione della catena va effettuata secondo gli intervalli specificati nelle Tabelle Manutenzione Programmata del presente manuale (vedi § 1.2.). È necessario effettuare questa operazione anche dopo ogni guida sotto la pioggia e dopo ogni lavaggio della motocicletta. L'uso della motocicletta con la catena in cattive condizioni o non lubrificata può dar luogo ad incidenti.



1

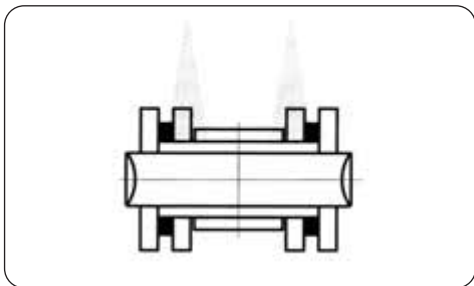



1

1.12. Regime di minimo - Controllo

Eseguire il controllo con il motore alla temperatura di esercizio.

Il regime di minimo deve essere compreso tra 1250 e 1350 rpm.

Se occorre effettuare la regolazione, rivolgersi ai centri assistenza autorizzati.





1.13. Sistema controllo emissioni evaporative

Le motociclette **MV Agusta DRAGSTER** sono equipaggiate con un sistema di controllo delle emissioni evaporative che impedisce la fuoriuscita di vapori di benzina dal serbatoio del carburante. Per mantenere nel tempo l'efficienza e l'affidabilità di questo dispositivo, fare eseguire le seguenti operazioni presso un centro assistenza autorizzato MV Agusta.

Controllo (e sostituzione se necessario)

Tubi e raccordi
Canister

Controllo (e pulizia se necessario)

Ingresso aria calda



CAUTELA: Le operazioni sopra indicate vanno effettuate secondo gli intervalli specificati nelle Tabelle Manutenzione Programmata del presente manuale (vedi § 1.2.).

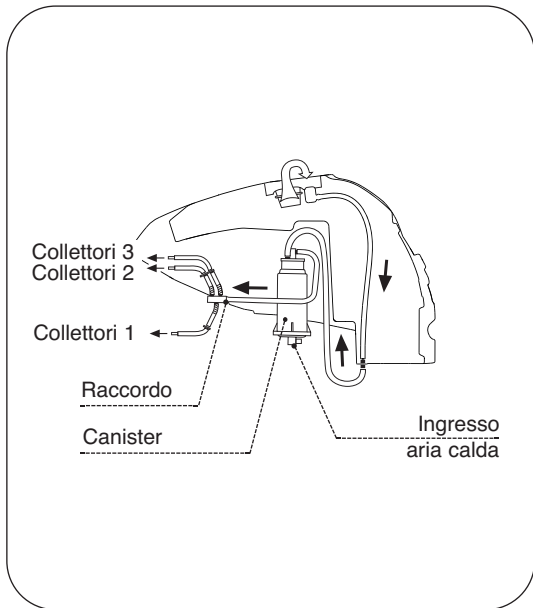









1

1.14. Sostituzioni - informazioni generali

La sostituzione dei fusibili e delle lampadine (ad esclusione di quelle indicate in tabella con il simbolo ) , può essere eseguita dal motociclista, seguendo correttamente le indicazioni fornite.

	Fusibile di ricarica batteria - Sostituzione (§1.14.1.)
	Fusibili - Sostituzione (§1.14.1.)
	Faro anabbagliante - Sostituzione lampadina (§1.14.2.)
	Faro abbagliante - Sostituzione lampadina (§1.14.3.)
	Indicatori di direzione - Sostituzione
	Luce targa - Sostituzione
	Fanale posteriore - Sostituzione
	Luce freno posteriore - Sostituzione

1.14.1. Fusibili - Sostituzione

► Il fusibile di ricarica batteria si trova sul teleruttore di avviamento, sul lato destro della motocicletta nella posizione indicata.

Per raggiungerlo occorre smontare il coperchio di protezione rimuovendo le due viti di fissaggio.

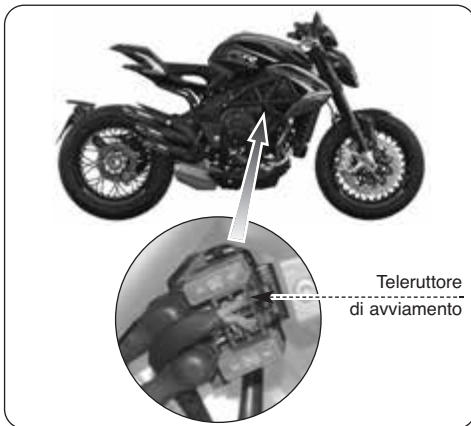



Cautela - Girare l'interruttore di accensione sulla posizione "OFF" prima di controllare o sostituire i fusibili, allo scopo di evitare cortocircuiti accidentali con conseguente rischio di danneggiare altri componenti elettrici.

- Per eseguire la sostituzione del fusibile occorre scambiare di posto il fusibile di ricarica ed il fusibile di scorta.



ATTENZIONE: Non utilizzare mai un fusibile con una taratura diversa da quella prescritta, allo scopo di evitare il danneggiamento dell'impianto elettrico della motocicletta con conseguente pericolo d'incendio.

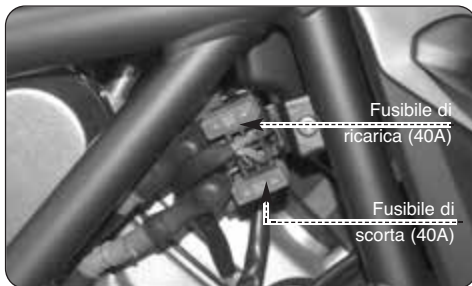



1

► I fusibili di servizio si trovano sul lato destro della motocicletta.

► Sganciare e sollevare il coperchio della scatola portafusibili.



Cautela - Girare l'interruttore di accensione sulla posizione "OFF" prima di controllare o sostituire i fusibili, allo scopo di evitare cortocircuiti accidentali con conseguente rischio di danneggiare altri componenti elettrici.





► Per identificare la posizione e la funzione dei fusibili, consultare le informazioni riportate sotto il coperchio della scatola e nello schema elettrico allegato; le lettere di riferimento indicate in figura corrispondono a quelle riportate nello schema.

Tenere presente che nella scatola portafusibili sono disponibili quattro fusibili di scorta.

► Sostituire il fusibile bruciato e rimontare il coperchio.



ATTENZIONE

Non utilizzare mai un fusibile con una taratura diversa da quella prescritta, allo scopo di evitare il danneggiamento dell'impianto elettrico della motocicletta con conseguente pericolo d'incendio.

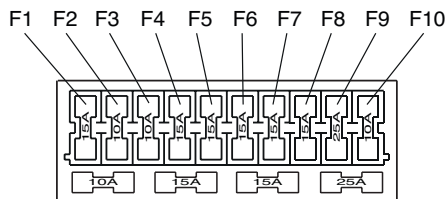



1

1.14.2. Faro anabbagliante - Sostituzione lampadina

► Rimuovere le quattro viti di fissaggio del faro anteriore, due sul lato destro e due sul lato sinistro della moto.



► Prima di rimuovere il faro anteriore dal veicolo, scollegare il connettore presente nella parte posteriore del fanale e i connettori degli indicatori di direzione anteriori.





- ▶ Adagiare il fanale su un tavolo allo scopo di potere effettuare le seguenti operazioni.
- ▶ Rimuovere la cuffia di protezione.
- ▶ Ruotare il connettore della lampadina del fano anabagliante in senso antiorario.
- ▶ Estrarre la lampadina.
- ▶ Scollegare i connettori della lampadina.



Cautela - Precauzione: Non toccare il vetro della lampadina con le mani. In caso di contatto pulire con un prodotto sgrassante.

- ▶ Riattaccare i connettori sulla lampadina nuova.
- ▶ Inserire la lampadina nuova.
- ▶ Ruotare il connettore della lampadina in senso orario.
- ▶ Rimettere in posizione la cuffia di protezione prestando attenzione a rispettarne il verso di montaggio.
- ▶ Reinserire il connettore del fanale e i connettori degli indicatori di direzione.
- ▶ Riposizionare il fanale sulla moto e riavvitare le quattro viti di fissaggio, facendo attenzione a reinserire i cavi nelle sedi laterali.

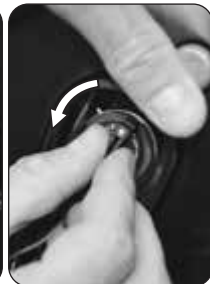

1

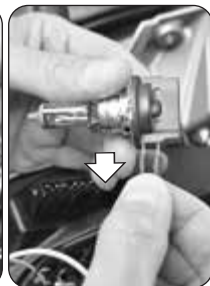



1.14.3. Faro abbagliante - Sostituzione lampadina

- ▶ Rimuovere il fanale anteriore dalla moto come descritto al paragrafo §1.14.2.
- ▶ Sganciare la molletta di ritegno della lampadina del faro abbagliante.
- ▶ Estrarre la lampadina.
- ▶ Scollegare il connettore della lampadina.



Cautela - Precauzione: Non toccare il vetro della lampadina con le mani. In caso di contatto pulire con un prodotto sgrassante.

- ▶ Riattaccare il connettore sulla lampadina nuova.
- ▶ Inserire la lampadina nuova prestando attenzione a rispettarne il verso di montaggio.
- ▶ Riagganciare la molletta di ritegno.
- ▶ Rimontare il fanale anteriore sulla moto come descritto al paragrafo §1.14.2.

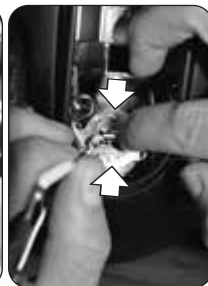



1.15. Batteria

Questo motociclo è equipaggiato con una batteria sigillata, installata sotto il serbatoio carburante. Tale elemento è esente da manutenzione, quindi non occorre controllare il liquido né aggiungere acqua distillata.

Se la batteria sembra scarica (causando problemi elettrici o un avviamento difficoltoso), caricarla al più presto possibile collegando il caricabatteria all'apposito connettore presente sotto la sella passeggero. Tenere presente che la batteria tende a scaricarsi più rapidamente se il motociclo è equipaggiato con accessori elettrici optional.



ATTENZIONE

Se il corpo esterno della batteria è danneggiato possono verificarsi fuoriuscite di acido solforico, una sostanza velenosa ed estremamente corrosiva. Evitare qualsiasi contatto con la pelle, gli occhi e gli abiti e proteggere sempre gli occhi quando si lavora vicino alla batteria.

In caso di contatto, prestare i **PRIMI SOCCORSI** come segue.

- **CONTATTO ESTERNO:** Sciacquare con molta acqua.
- **CONTATTO INTERNO:** Bere grandi quantità di acqua o latte e chiamare immediatamente un medico.
- **OCCHI:** Sciacquare con acqua per 15 minuti e ricorrere immediatamente ad un medico.

La fuoriuscita di acido solforico comporta inoltre la formazione di idrogeno, il quale può provocare un'esplosione in presenza di una scintilla o di una fiamma.

Per effettuare la sostituzione della batteria è necessario rivolgersi ad un centro assistenza autorizzato MV Agusta.



1

Inattività prolungata

Se la motocicletta è destinata a non essere utilizzata per un periodo prolungato (un mese o più), è consigliabile rimuovere il fusibile di ricarica (vedi §1.14.1). In caso di lunga inattività si raccomanda di ricaricare la batteria una volta al mese, al fine di garantirne la durata nel tempo.

Per eseguire questa operazione collegare il caricabatteria all'apposito connettore presente sotto la sella passeggero, con il fusibile di ricarica inserito nel teleruttore di avviamento.

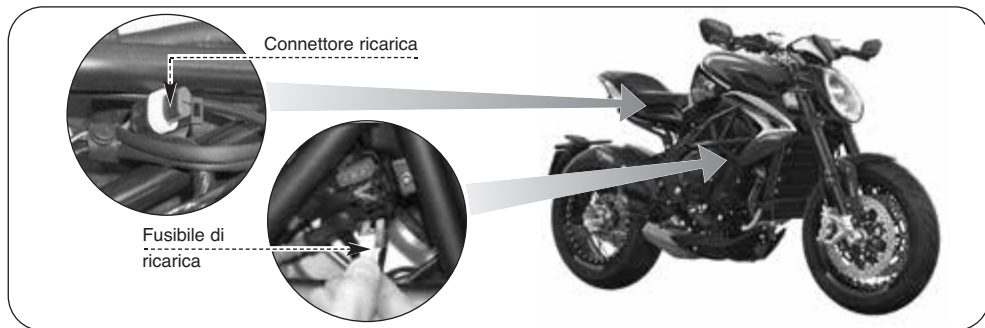



1.16. Pulizia della motocicletta

La pulizia periodica e accurata è importante per mantenere nel tempo il valore della motocicletta, proteggere la finitura delle sue superfici e controllare che non vi siano danni, usura e perdita di fluidi corrosivi.



Cautela - Precauzione: Prima di effettuare il lavaggio otterrare i tubi di scarico e proteggere le parti elettriche.



ATTENZIONE

Se la motocicletta è ancora calda per un uso recente, attendere che il motore e l'impianto di scarico si siano raffreddati.



Cautela - Precauzione: non utilizzare macchine di lavaggio con getti di acqua ad alta pressione o di vapore, in quanto possono provocare infiltrazioni di acqua e deterioramento dei componenti della motocicletta.



NOTA: I detersivi inquinano l'ambiente. Pertanto la pulizia del veicolo va effettuata in zone attrezzate per la raccolta e la depurazione dei liquidi di lavaggio.



1

Lavare con acqua, spugna e usare un detergente non aggressivo. Asciugare con un panno morbido. Nelle zone meno accessibili usare un getto d'aria.

**Cautela - Precauzione:**

- **Accertarsi di non utilizzare panni o spugne che siano stati a contatto con prodotti di pulizia forti o abrasivi, solventi, alcool o benzina.**
- **Per evitare danni irreversibili ai componenti della carrozzeria non usare detergenti alcalini o di elevata acidità, benzina, liquido per freni o altri solventi.**
- **In caso di dubbio sulla composizione chimica del detergente, testare l'effetto del prodotto su una piccola area prima di procedere con l'uso esteso.**

Periodicamente, trattare le parti verniciate con prodotti specifici. Se si percorrono strade trattate con prodotti corrosivi (sale) eseguire il lavaggio appena possibile, utilizzando acqua fredda; l'acqua calda favorisce l'azione corrosiva.

**ATTENZIONE**

Accertarsi che non ci sia olio o cera sui freni o sui pneumatici. Se necessario, pulire i dischi dei freni con un detergente per dischi freno e lavare i pneumatici con acqua calda ed un detergente neutro.

**ATTENZIONE**

Se i freni sono bagnati, possono provocare una riduzione della potenza di frenata ed incidenti. Dopo il lavaggio avviare il motore per qualche minuto ponendosi in marcia ad andatura ridotta, ed eseguire alcune frenate con cautela per asciugare le pastiglie e i dischi dei freni.







**ATTENZIONE**

La catena di trasmissione deve essere lubrificata subito dopo il lavaggio e l'asciugamento della motocicletta secondo le istruzioni riportate nel §1.11. del presente manuale.



1.17. Periodo di sosta prolungata

Se si prevede di tenere la motocicletta ferma per un lungo periodo, è bene eseguire le operazioni di seguito elencate.

-  Vuotare il serbatoio carburante.
-  Rimuovere il fusibile di ricarica (§1.14.1). Ricaricare la batteria una volta al mese (§1.15.).
-  Togliere i cappucci delle candele e le candele. Versare un cucchiaino di olio motore in ciascun foro delle candele, dopodiché reinstallare le candele e i relativi cappucci e far ruotare a vuoto il motore per alcune volte.
-  Lubrificare tutti i cavi di comando ed i punti di rotazione di tutte le leve e dei pedali.
-  Pulire la motocicletta e trattare con prodotti specifici le parti verniciate (§1.16.).
-  Allo scopo di garantire l'integrità e le prestazioni dei pneumatici, parcheggiare la moto in un ambiente fresco, asciutto e buio, con una temperatura relativamente costante e inferiore a 25°C. Evitare il contatto diretto dei pneumatici con tubazioni o radiatori di riscaldamento, ed il contatto prolungato con olio o benzina. Evitare di collocare i pneumatici nelle vicinanze di motori elettrici o attrezzature passibili di generare scintille o scariche elettriche. Durante il periodo di sosta, mantenere la moto sollevata sul cavalletto posteriore.
-  Ricoprire la motocicletta con un apposito telo.

Al primo utilizzo della motocicletta ricordarsi di eseguire una verifica generale e far eseguire la manutenzione (§1.2.) se necessario.



2.1. Posizione del connettore diagnostica

Il connettore per il software diagnostica si trova sotto la sella pilota. Per raggiungerlo occorre rimuovere la sella come descritto nel paragrafo §4.6. del Manuale Utente.

Per effettuare la connessione hardware è necessario collegare l'apposito cavo di interfaccia (da ordinare tramite il Servizio Ricambi MV Agusta) al connettore diagnostica.

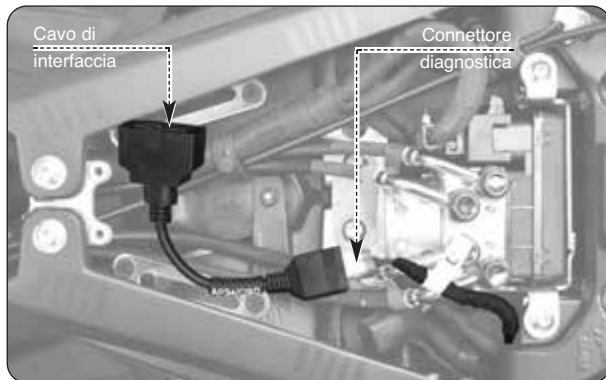

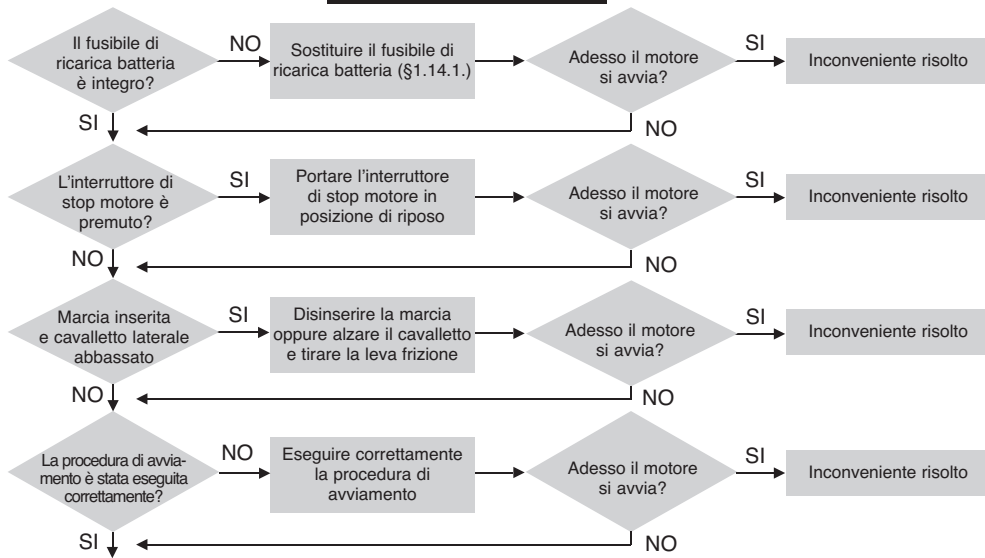
**2.2. Inconvenienti al motore: IL MOTORE NON SI AVVIA**

continua nella pagina successiva



continua dalla pagina precedente

2

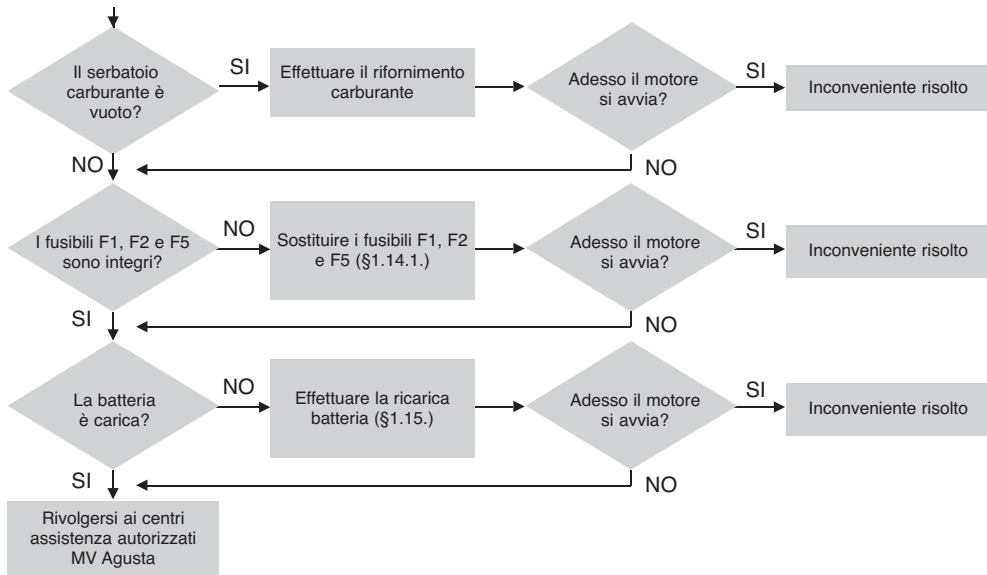



IL MOTORE SI SPEGNE DURANTE LA MARCIA

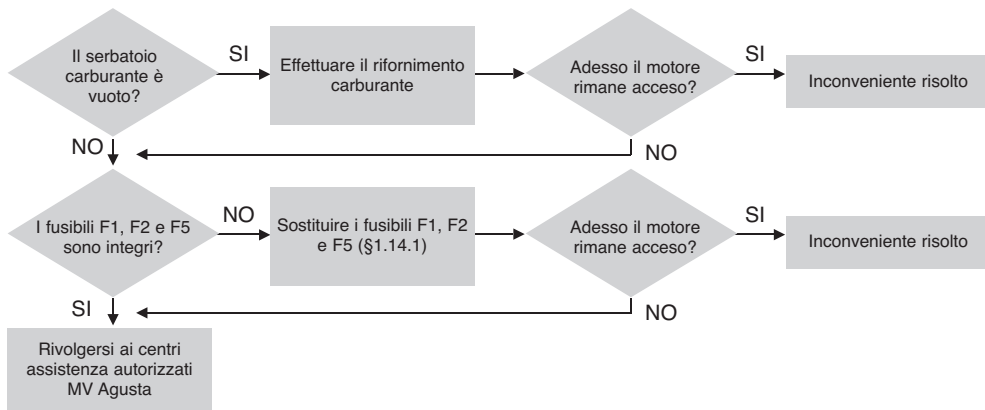

**IL MOTORE SI SURRISCALDA**

2

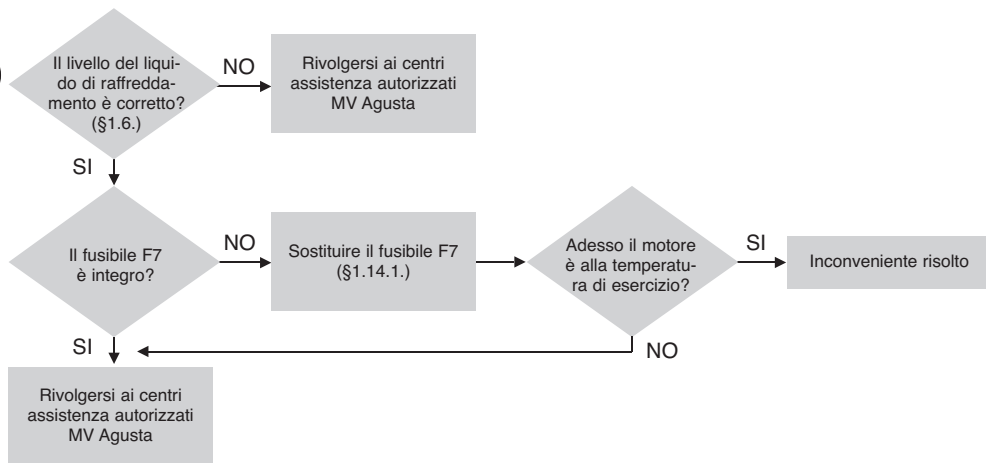



LA PRESSIONE DELL'OLIO È INSUFFICIENTE (Accensione spia pressione olio con motore in moto)





2.3. Inconvenienti all'impianto elettrico: **LE LUCI NON FUNZIONANO**

2

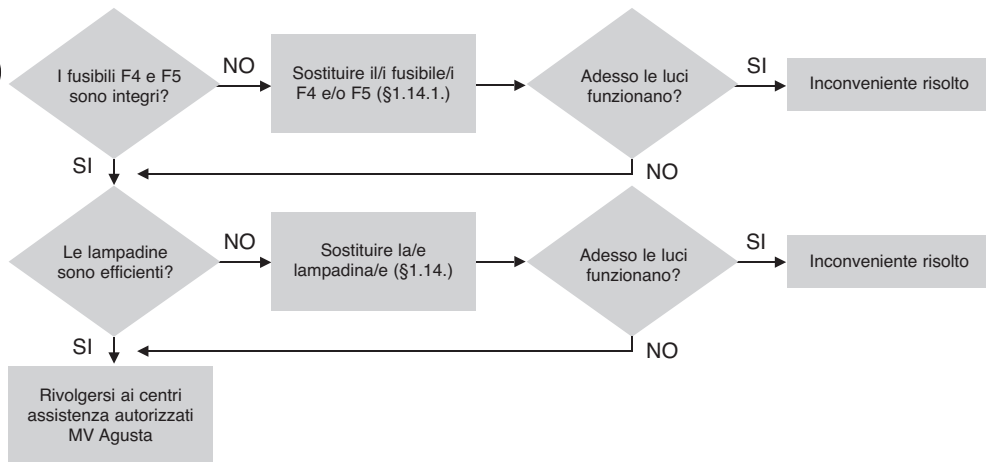



L'AVVISATORE ACUSTICO NON FUNZIONA

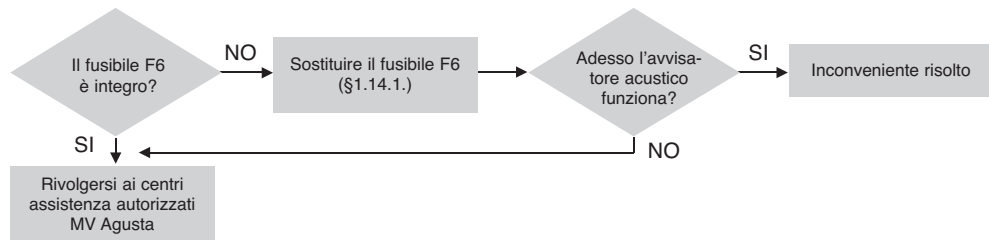

2

IL CRUSCOTTO NON FUNZIONA

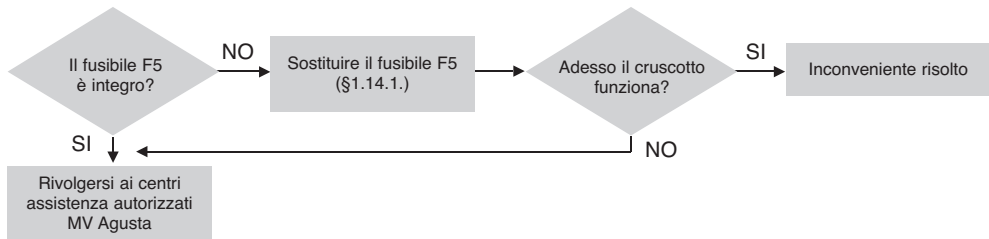



3.1. Descrizione generale della motocicletta

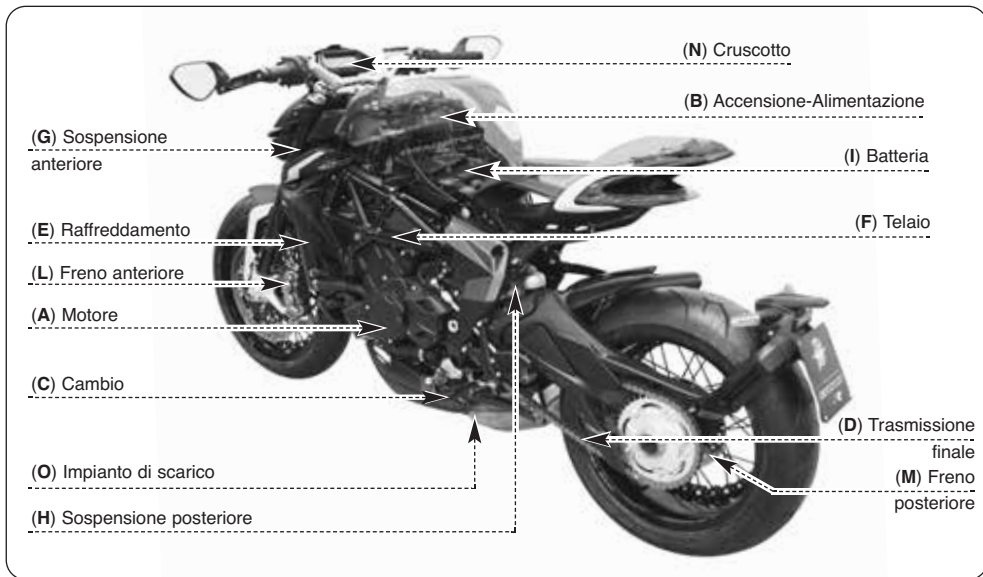



- A - Motore:** quattro tempi, tre cilindri in linea. Distribuzione a doppio albero a camme in testa. Lubrificazione a carter umido.
- B - Accensione - Alimentazione:** sistema integrato d'accensione - iniezione. Accensione elettronica a scarica induttiva. Iniezione elettronica "Multipoint".
- C - Cambio:** del tipo estraibile, a sei rapporti con ingranaggi sempre in presa.
- D - Trasmissione finale:** composta da pignone, corona e catena.
- E - Raffreddamento:** a liquido e olio con radiatori separati.
- F - Telaio:** a traliccio, in tubolare d'acciaio, con piastre laterali in alluminio.
- G - Sospensione anteriore:** forcella oleodinamica a steli rovesciati dotata di sistema esterno di regolazione.
- H - Sospensione posteriore:** ad azione progressiva con monobraccio oscillante e monoammortizzatore dotato di sistema esterno di regolazione.
- I - Batteria:** sigillata ed esente da manutenzione.
- L - Freno anteriore:** doppio disco semi-flottante con pinze a quattro pistoncini.
- M - Freno posteriore:** disco singolo con pinza a due pistoncini.
- N - Cruscotto:** dotato di spie segnalatrici e strumentazione digitale.
- O - Impianto di scarico:** dotato di convertitore catalitico per la riduzione delle emissioni inquinanti.



3.1.1. Impianto frenante (ABS)

3

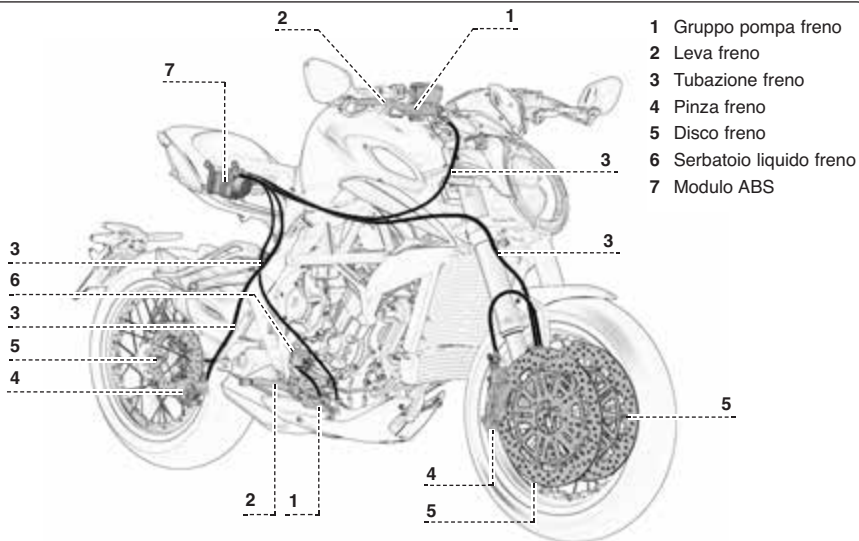



3.1.2. Lubrificazione motore

- 1 Coppa olio
- 2 Filtro olio

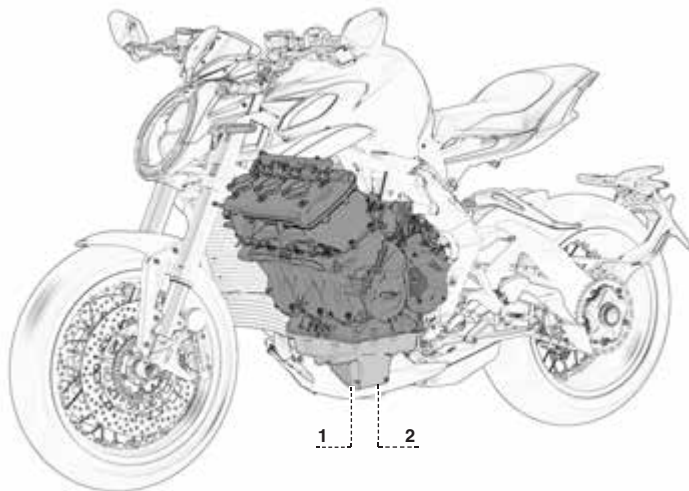

3



3.1.3. Circuito di raffreddamento

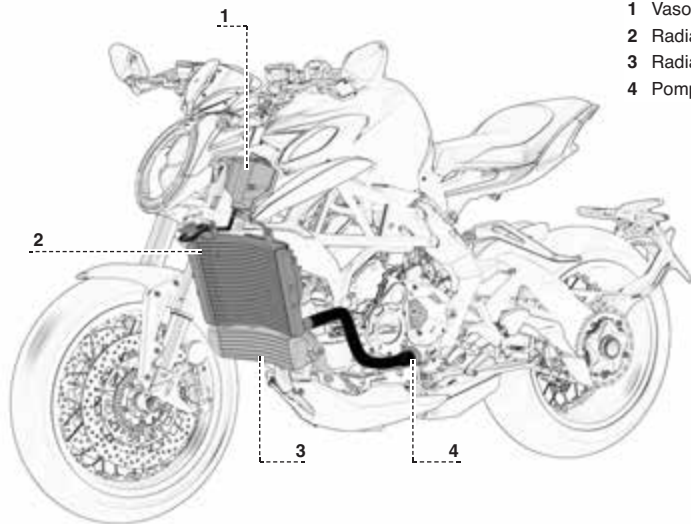

- 1 Vaso espansione
- 2 Radiatore superiore
- 3 Radiatore inferiore
- 4 Pompa liquido



3.1.4. Circuito di alimentazione

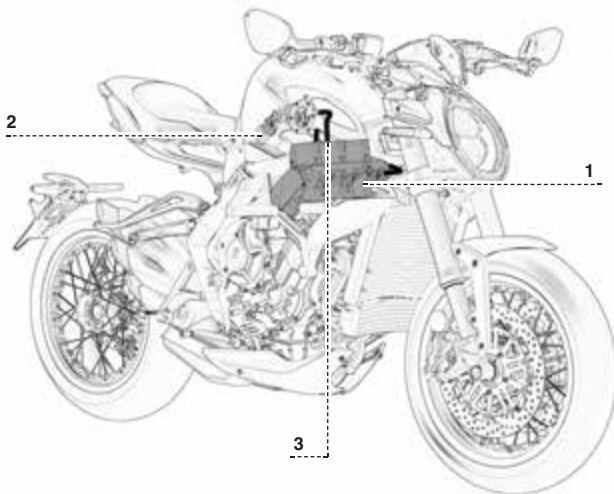

- 1 Corpi farfallati
- 2 Pompa carburante
- 3 Tubazione carburante



3.2. Dati tecnici

Descrizione	Dragster 800 Rosso	Dragster RR / RR SCS	Dragster RC / RC SCS
CARATTERISTICHE			
Interasse (mm) (*)	1400	1400	1400
Lunghezza totale (mm) (*)	2035	2035	2035
Larghezza max. (mm)	935	935	935
Altezza sella (mm) (*)	845	845	845
Altezza min. da terra (mm) (*)	135	135	135
Avancorsa (mm) (*)	103,5	103,5	103,5

*: I dati dichiarati non sono vincolanti. Essi sono suscettibili di variazioni in funzione delle condizioni di assetto del veicolo.



Dati tecnici

Descrizione	Dragster 800 Rosso	Dragster RR / RR SCS	Dragster RC / RC SCS
Peso a secco (kg)	168	168	168
Capacità serbatoio carburante (l) (*)	16,5	16,5	16,5
Riserva carburante (l) (*)	4	4	4
Q.tà olio nel basamento (kg)	2,5	2,5	2,5
MOTORE			
Tipo	Tre cilindri, 4 tempi, 12 valvole		
Alesaggio (mm)	79,0	79,0	79,0
Corsa (mm)	54,3	54,3	54,3
Cilindrata totale (cm ³)	798	798	798
Rapporto di compressione	12,3 : 1	13,3 : 1	13,3 : 1
Norma ambientale	Euro 4	Euro 4	Euro 4
Emissioni di CO ₂ (g/km)	128	163	163
Consumo di carburante (l/100 km)	5,6	6,7	6,7
Avviamento	Elettrico		
Raffreddamento	A liquido e olio con radiatori separati		
Carter motore e coperchi	Pressofusi		
Testa e cilindri	Fusi in conchiglia		
Valvole	Acciaio		

* : I dati dichiarati non sono vincolanti. Essi sono suscettibili di variazioni in funzione della temperatura esterna, della temperatura del motore e del punto di evaporazione della benzina utilizzata.



Dati tecnici

Descrizione	Dragster 800 Rosso	Dragster RR / RR SCS	Dragster RC / RC SCS
DISTRIBUZIONE			
Tipo	Doppio albero a camme in testa		
LUBRIFICAZIONE			
Tipo	A carter umido		
ACCENSIONE - ALIMENTAZIONE			
Tipo	Sistema integrato di accensione-iniezione MVICS. Centralina di controllo motore Eldor EM2.0; corpo farfallato full drive by wire Mikuni; bobine pencil-coil con tecnologia "ion-sensing", controllo detonazione e misfire. Controllo di coppia con 4 mappe; Traction Control ad 8 livelli di intervento.		
Numero iniettori	3	6	6
Candele	NGK CR9 EIB-9	NGK CR9 EIB-9	NGK CR9 EIB-9
Distanza elettrodi (mm)	0.8 ÷ 0.9	0.8 ÷ 0.9	0.8 ÷ 0.9
FRIZIONE			
Tipo	Multidisco in bagno d'olio a comando idraulico con dispositivo antisaltellamento meccanico		
TRASMISSIONE PRIMARIA			
Numero denti ingranaggio contralbero	Z = 22	Z = 22	Z = 22
Numero denti ingranaggio frizione	Z = 41	Z = 41	Z = 41
Rapporto di trasmissione	1,864	1,864	1,864
TRASMISSIONE SECONDARIA			
Numero denti pignone	Z = 16	Z = 16	Z = 16
Numero denti corona	Z = 41	Z = 41	Z = 41
Rapporto di trasmissione	2,563	2,563	2,563



Dati tecnici

Descrizione	Dragster 800 Rosso	Dragster RR / RR SCS	Dragster RC / RC SCS
CAMBIO VELOCITÀ			
Tipo	Estraibile a sei velocità con ingranaggi sempre in presa		
Rapporti cambio (rapporti totali)			
Prima	2.846 (13.593)	2.846 (13.593)	2.846 (13.593)
Seconda	2.187 (10.447)	2.125 (10.149)	2.125 (10.149)
Terza	1.778 (8.635)	1.778 (8.635)	1.778 (8.635)
Quarta	1.500 (7.165)	1.579 (7.541)	1.579 (7.541)
Quinta	1.318 (6.295)	1.429 (6.823)	1.429 (6.823)
Sesta	1.190 (5.684)	1.318 (6.295)	1.318 (6.295)
TELAIO			
Tipo	Tubolare a traliccio in acciaio ALS (saldato in MAG)		
Piastre fulcro forcellone	Lega di alluminio		
SOSPENSIONE ANTERIORE			
Tipo	Forcella oleodinamica a steli rovesciati con sistema di regolazione esterno e separato del freno in estensione, in compressione e del precarico molla		
Ø steli (mm)	43	43	43
Corsa sull'asse gambe (mm)	125	125	125
SOSPENSIONE POSTERIORE			
Tipo	Progressiva, monoammortizzatore regolabile in estensione, in compressione e nel precarico molla		
Forcellone	Lega di alluminio		
Corsa ruota (mm)	124	124	124



Dati tecnici

Descrizione	Dragster 800 Rosso	Dragster RR / RR SCS	Dragster RC / RC SCS
FRENO ANTERIORE			
Tipo	A doppio disco flottante con fascia frenante in acciaio		
Ø disco (mm)	320		
Flangia disco	Acciaio		
Pinze (diametro pistoncini mm)	Radiale a 4 pistoncini (Ø 32)		
FRENO POSTERIORE			
Tipo	A disco in acciaio		
Ø disco (mm)	220		
Pinza (diametro pistoncini mm)	A 2 pistoncini (Ø 34)		
CERCHIO ANTERIORE			
Materiale	Lega di alluminio	Ruota a raggi in lega di alluminio	Forgiato in lega di alluminio
Dimensione	3.50" x 17"	3.50" x 17"	3.50" x 17"
CERCHIO POSTERIORE			
Materiale	Lega di alluminio	Ruota a raggi in lega di alluminio	Forgiato in lega di alluminio
Dimensione	6.00" x 17"	6.00" x 17"	6.00" x 17"
PNEUMATICI			
Anteriore	120/70 ZR 17 M/C (58 W)	120/70 ZR 17 M/C (58 W)	120/70 ZR 17 M/C (58 W)
Posteriore	200/50 ZR 17 M/C (75 W)	200/50 ZR 17 M/C (75 W)	200/50 ZR 17 M/C (75 W)



Dati tecnici

Descrizione	Dragster 800 Rosso	Dragster RR / RR SCS	Dragster RC / RC SCS
Marca e tipo	PIRELLI Diablo Rosso II	PIRELLI Diablo Rosso II	PIRELLI Diablo Rosso II
Pressione di gonfiaggio (*):			
Anteriore	2.5 bar (36 psi)	2.5 bar (36 psi)	2.5 bar (36 psi)
Posteriore	2.8 bar (41 psi)	2.8 bar (41 psi)	2.8 bar (41 psi)
IMPIANTO ELETTRICO			
Tensione impianto	12 V		
Luce anabbagliante anteriore	H11B 12V 55W		
Luce abbagliante anteriore	H3 12V 55W		
Indicatori di direzione	LED		
Luce di posizione posteriore	LED		
Luce freno posteriore	LED		
Batteria	12 V - 8,6Ah		
Alternatore	350 W a 5000 giri/min.		
CARROZZERIA			
Serbatoio	Materiale termoplastico		
Fianchetti serbatoio	Materiale termoplastico	Materiale termoplastico	Fibra di carbonio
Fianchetti posteriori	Materiale termoplastico		

* : Nell'eventualità di utilizzo di pneumatici di marche differenti da quelle consigliate, riferirsi al valore della pressione di gonfiaggio marcato dal costruttore sul fianco del pneumatico.



Dati tecnici

Descrizione	Dragster 800 Rosso	Dragster RR / RR SCS	Dragster RC / RC SCS
Protezione strumentazione	Materiale termoplastico	Materiale termoplastico	Fibra di carbonio
Parafango posteriore	Materiale termoplastico	Materiale termoplastico	Fibra di carbonio
Parafango anteriore	Materiale termoplastico		
Supporti parafango anteriore	Materiale termoplastico	Materiale termoplastico	Fibra di carbonio
Fianchetti air-box	Materiale termoplastico		
Protezioni catena	Materiale termoplastico		
Portatarga	Materiale termoplastico		
Specchietti retrovisori	Materiale termoplastico		
Protezione tubo scarico	Alluminio		
Protezioni laterali radiatore	Materiale termoplastico		





3





3.3. Riferimento colori componenti sovrastrutture (Dragster 800 Rosso)

Le parti verniciate delle sovrastrutture presentano i seguenti colori di riferimento:

1. - Serbatoio benzina:

Rosso F4 Ago
(Cod. Palinal 926R750)

- 2. - Fianchetto centrale destro;
- 3. - Fianchetto centrale sinistro;
- 4. - Fianchetto anteriore destro;
- 5. - Fianchetto anteriore sinistro;
- 6. - Fianchetto posteriore destro;
- 7. - Fianchetto posteriore sinistro:

Nero Carbon Metallizzato
(Cod. Palinal 928.V311)



3





3.4. Riferimento colori componenti sovrastrutture (Dragster RR / RR SCS MY20)

Le parti verniciate delle sovrastrutture presentano i seguenti colori di riferimento, in relazione al rispettivo codice colore della motocicletta:

1. - Serbatoio benzina:

- **Codice colore A:**

Grigio Notte

(Cod. Lechler LCH29902-662) +

Nero Carbon Metallizzato

(Cod. Palinal 928.V311)

- **Codice colore B:**

Bianco ICE Perlato

(Cod. Lechler 2902181) +

Nero Carbon Metallizzato

(Cod. Palinal 928.V311)

2. - Fianchetto centrale destro;

3. - Fianchetto centrale sinistro:

Nero Carbon Metallizzato

(Cod. Palinal 928.V311)

4. - Fianchetto anteriore destro;

5. - Fianchetto anteriore sinistro;

6. - Fianchetto posteriore destro;

7. - Fianchetto posteriore sinistro:

- **Codice colore A:**

Giallo Metallizzato Perlato

(Cod. Lechler LCC00997 +

Lechler LCC00998)

- **Codice colore B:**

Verde Neon

(Cod. Lechler BDCR216)



3





3.5. Riferimento colori componenti sovrastrutture (Dragster RC / RC SCS MY20)

Le parti verniciate delle sovrastrutture presentano i seguenti colori di riferimento:

1. - Serbatoio benzina;
2. - Fianchetto anteriore destro;
3. - Fianchetto anteriore sinistro:

Grigio Avio Metallizzato
(Cod. Palinal 928.T892) +
Nero Carbon Metallizzato
(Cod. Palinal 928.V311)

4. - Parafango anteriore;
5. - Fianchetto airbox destro;
6. - Fianchetto airbox sinistro;
7. - Fianchetto posteriore destro;
8. - Fianchetto posteriore sinistro:

Grigio Avio Metallizzato
(Cod. Palinal 928.T892)



3

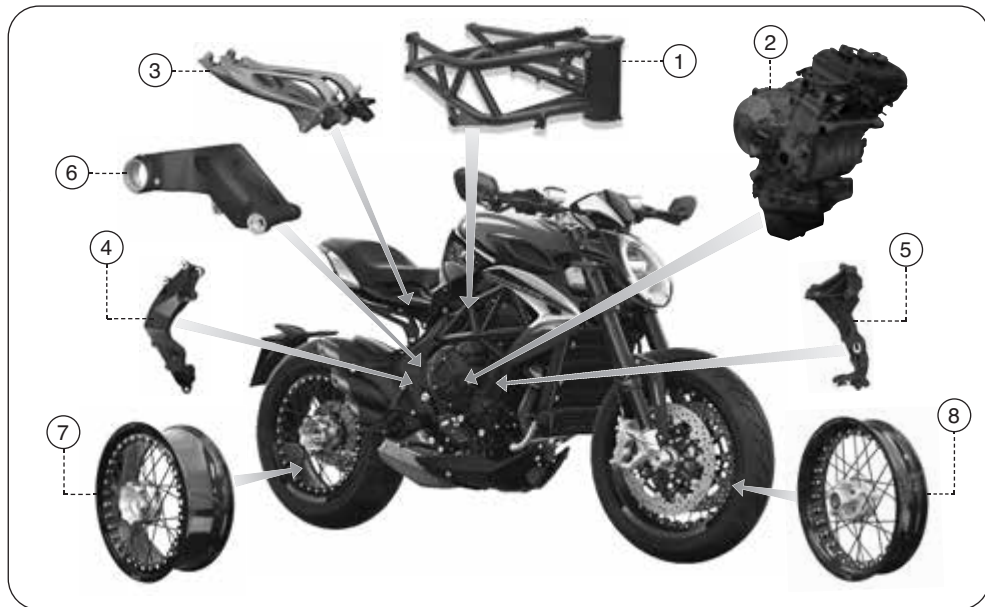



3.6. Riferimento colori componenti telaio e ciclistica

Le parti verniciate di telaio e ciclistica della motocicletta presentano i seguenti colori di riferimento:

1. - Telaio:

- **Dragster 800 / RR / RR SCS MY20:**
Nero Lucido (Cod. PPG PCU 90207)
- **Dragster RC / RC SCS MY20:** Rosso
Ciclistica (Cod. Akzo Nobel QG000K Red)

- 3. - **Telaio posteriore;**
- 4. - **Piastra fulcro forcellone destra;**
- 5. - **Piastra fulcro forcellone sinistra;**
- 6. - **Forcellone posteriore:**

Nero Quasar
(Cod. Inver 61196 - Poliest/HD TGIC Free)

2. - Motore:

Nero Opaco
(Cod. Pulverit 3500/0085)

- 7. - **Cerchio ruota posteriore;**
- 8. - **Cerchio ruota anteriore:**

- **Dragster 800 Rosso:** Nero Lucido
(Cod. Peter Lacke VPCH03250)
- **Dragster RR / RR SCS MY20:**
Nero Lucido
- **Dragster RC / RC SCS MY20:**
Rosso Lucido (Cod. Da Qiao
WFMY-S09-Q + WFMY-S10-Q)



Nota informativa

MV Agusta Motor S.p.A. è impegnata in una politica di continuo miglioramento dei propri prodotti; per questa ragione potrebbe essere possibile riscontrare leggere differenze tra quanto riportato nel presente documento ed il veicolo da Voi acquistato. I modelli MV Agusta vengono esportati in numerosi Paesi, nei quali valgono norme differenti in relazione al Codice della Strada ed alle procedure di omologazione. Contando sulla Vostra comprensione, MV Agusta Motor S.p.A. ritiene quindi necessario riservarsi il diritto di apportare modifiche ai propri prodotti ed alla propria documentazione tecnica in qualsiasi momento e senza fornire preavviso.

Vi consigliamo di visitare periodicamente il sito Internet **www.mvagusta.com** per ottenere informazioni ed aggiornamenti sui prodotti MV Agusta e sulla relativa documentazione.



Rispettiamo e difendiamo l'ambiente

Tutto ciò che facciamo ha ripercussioni sull'intero pianeta e sulle sue risorse. MV Agusta, a tutela degli interessi della comunità, sensibilizza i Clienti e gli operatori dell'assistenza tecnica ad adottare modalità d'uso del mezzo e di smaltimento di sue parti, nel pieno rispetto delle normative vigenti in termini di inquinamento ambientale, smaltimento e riciclaggio dei rifiuti.

© 2020

È vietata la riproduzione anche parziale di questo documento senza il consenso scritto della MV Agusta Motor S.p.A.

Part. n° 8000C8714

Edizione n° 1 - Gennaio 2020

MV AGUSTA

**DRAGSTER
EBOOR**



Maintenance manual
English Version



CONTENTS

<i>chap.</i>	<i>Subject covered</i>	<i>page</i>
1	MAINTENANCE	3
1.1.	Symbols	3
1.2.	Tables of scheduled maintenance and checks	4
1.3.	Tools and accessories supplied	14
1.4.	Table of lubricants and fluids	15
1.5.	Checking the engine oil level	16
1.5.1.	Topping up the engine oil level	17
1.6.	Checking the coolant level	19
1.6.1.	Topping up the coolant level	20
1.7.	Checking the wear of the brake pads	22
1.8.	Checking the brake fluid level	23
1.9.	Checking the clutch fluid level	25
1.10.	Checking and replacing the tyres	26
1.11.	Checking and lubricating the drive chain	32
1.12.	Checking the idle speed	36
1.13.	Evaporative emission control system	37
1.14.	Replacing parts - General information	38
1.14.1.	Replacing the fuses	38
1.14.2.	Replacing the low beam bulb	42
1.14.3.	Replacing the high beam bulb	44
1.15.	Battery	45
1.16.	Cleaning the motorcycle	47
1.17.	Prolonged inactivity	49

<i>chap.</i>	<i>Subject covered</i>	<i>page</i>
2	TROUBLESHOOTING FLOW CHART	50
2.1.	Diagnostic connector position	50
2.2.	Engine problems	51
2.3.	Electrical equipment problems	56
3	TECHNICAL INFORMATION	58
3.1.	Motorcycle overview	58
3.1.1.	Braking system (ABS)	60
3.1.2.	Engine lubrication	61
3.1.3.	Coolant circuit	62
3.1.4.	Fuel system	63
3.2.	Specifications	64
3.3.	Bodywork parts reference colours (Dragster 800 Rosso)	72
3.4.	Bodywork parts reference colours (Dragster RR / RR SCS MY20)	74
3.5.	Bodywork parts reference colours (Dragster RC / RC SCS MY20)	76
3.6.	Frame parts reference colours	78



1.1. Symbols

Sections of text that are particularly important in terms of personal safety or possible damage to the motorcycle are marked with the following symbols:



Danger - Failure to observe these prescriptions, even in part, may pose a serious hazard to the driver's and other people's safety.



Caution - Failure to observe these prescriptions, even in part, may result in damage to the motorcycle.

The following symbols give an indication of who is supposed to perform the different adjustments and/or maintenance operations:



Information on operations that can be carried out by the user.



Information on operations that must be carried out only by authorized personnel.

The following symbols are used to provide further information:



The “” symbol points out the requirement to use a tool or a special equipment in order to correctly perform the described operation.



The “§” symbol refers the reader to the chapter identified by the number that follows.



1.2. Tables of scheduled maintenance and checks

The main periodic checks and maintenance operations are shown in the following tables. These operations are necessary to keep the motorcycle safe and in perfect running order.

The intervals indicated in the periodic maintenance and lubrication tables must be intended as a general guide under normal riding conditions. It could be necessary to reduce these intervals according to the climate, the ground conditions, the geographic position and the conditions of use.

Some of the operations can be carried out by the user, providing he or she possesses the requisite skills. If unskilled, have the operations performed by an authorized service centre.

As a rule maintenance operations must be performed while the motorcycle is on the rear stand after switching off the engine and setting the start switch to OFF. On the contrary, while checking the fluid levels it is advisable to keep the motorcycle in an upright position without using the rear stand.

After the first 105,000 km (63,000 mi) the operations must be performed at the same intervals shown in the tables.

**WARNING**

- Improprity or lack of recommended maintenance operations can lead to an increase of the risk of accidents and damage to the motorcycle.
- Always use genuine MV Agusta spare parts. Using non-genuine spare parts can accelerate the wear of your motorcycle and shorten its life.
- Failure to perform the recommended operations, as well as using non-genuine spare parts, could cause the warranty not to be operating.
- To replace or top up the lubricants and fluids of your motorcycle, use only the products given at paragraph 1.4.

**WARNING**

If you use the motorcycle on race track, we recommend to have the bike checked before and after using it by skilled personnel belonging to the MV Agusta Service Centers network. Using the motorcycle on road track is allowed only occasionally and, however, not for competitive purpose, even during amateur events. Using the motorcycle on road track could cause a considerable increase of the wear of its components, which would bring to a reduction of their life duration with reference to a normal use on road or highway route.



Tables of scheduled maintenance

(*): The mileage coupons can be carried along with the **mandatory annual coupon**

km (mi) covered*		0	1000 (600)	Every year	15000 (9000)	30000 (18000)	45000 (27000)	60000 (36000)	75000 (45000)	90000 (54000)	105000 (63000)
Service coupon		Deli- very	A		B	C	D	E	F	G	H
DESCRIPTION		OPERATION									
Engine control unit		Check mapping	•	•	•	•	•	•	•	•	•
Engine oil		Check / Restore level	Every time vehicle is used								
		Check / Restore level	•								
		Renew	•	•	•	•	•	•	•	•	•
Engine oil filter		Renew (Use only original oil filters MV Agusta)	Every time engine oil is changed								
Coolant		Check / Restore level	Every time vehicle is used								
		Check / Restore level	•	•	•	•	•	•	•	•	•
		Renew	At least every two years								
Cooling system		Check for leakage	•	•	•	•	•	•	•	•	•
Electric fan		Check operation	•	•	•	•	•	•	•	•	•
Valves		Check / Adjust				•		•		•	
Timing chain		Replace									•



Tables of scheduled maintenance

(*): The mileage coupons can be carried along with the **mandatory annual coupon**

km (mi) covered*		0	1000 (600)	Every year	15000 (9000)	30000 (18000)	45000 (27000)	60000 (36000)	75000 (45000)	90000 (54000)	105000 (63000)
Service coupon		Deli- very	A		B	C	D	E	F	G	H
DESCRIPTION		OPERATION									
Timing fixed shoe		Replace									•
Timing movable shoe		Replace									•
Timing chain stretcher		Replace									•
Spark plugs		Replace				•		•		•	
Fuel filter		Replace				•		•		•	
Throttle body		Check / clean ducts				•		•		•	
		Check pressure sensor				•		•		•	
Air filter (Reduce mileage intervals when riding in highly polluted areas)		Check / Replace			•		•		•		•
		Replace				•		•		•	
Cylinders		Check compression				•		•		•	
Brakes / Clutch fluid		Check level	Every time vehicle is used								
		Check level	•	•	•	•	•	•	•	•	•
		Renew	At least every two years								



Tables of scheduled maintenance















(*): The mileage coupons can be carried along with the **mandatory** annual coupon

km (mi) covered*		0	1000 (600)	Every year	15000 (9000)	30000 (18000)	45000 (27000)	60000 (36000)	75000 (45000)	90000 (54000)	105000 (63000)
Service coupon		Deli- very	A		B	C	D	E	F	G	H
DESCRIPTION		OPERATION									
Brakes / Clutch		Check operation									
		•	•	•	•	•	•	•	•	•	•
			•	•	•	•	•	•	•	•	•
Clutch spring drive											•
Brake pads (front and rear)		Check wear									
		•		•	•	•	•	•	•	•	•
Fuel lines and connections			•	•	•	•	•	•	•	•	•
		Replace									
Throttle control		Check operation									
		•	•	•	•	•	•	•	•	•	•
Rear sprocket spring drive				•							
			•	•							
					•	•	•	•	•	•	•



Tables of scheduled maintenance

















(*): The mileage coupons can be carried along with the **mandatory** annual coupon

km (mi) covered*		0	1000 (600)	Every year	15000 (9000)	30000 (18000)	45000 (27000)	60000 (36000)	75000 (45000)	90000 (54000)	105000 (63000)
Service coupon		Deli- very	A		B	C	D	E	F	G	H
DESCRIPTION		OPERATION									
Drive chain 		Every 1000 Km (600 mi)									
		Every 1000 Km (600 mi) and after riding under the rain									
		•	•	•	At least every 1000 Km (600 mi)						
		At least every 1000 Km (600 mi)									
					•	•	•	•	•	•	•
Front sprocket / Tab washer			•	•							
					•	•	•	•	•	•	•
Rear sprocket			•	•							
					•	•	•	•	•	•	•
Tyres		Every time vehicle is used; at least every 10 days									
		Every time vehicle is used; at least every 500 Km (300 mi)									
		•	•	•	•	•	•	•	•	•	•
			•	•	•	•	•	•	•	•	•



Tables of scheduled maintenance













(*): The mileage coupons can be carried along with the **mandatory** annual coupon

km (mi) covered*		0	1000 (600)	Every year	15000 (9000)	30000 (18000)	45000 (27000)	60000 (36000)	75000 (45000)	90000 (54000)	105000 (63000)
Service coupon		Deli- very	A		B	C	D	E	F	G	H
DESCRIPTION		OPERATION									
Steering bearings 			•		•		•		•		•
						•		•		•	
Wheel rims 		•	•	•	•	•	•	•	•	•	•
		Every time tyre is replaced									
Wheel spokes (Dragster RR-SCS) 			•	•	•	•	•	•	•	•	•
		At least once a year									
Front wheel bearings 					•	•	•		•	•	•
		Every time tyre is replaced									
Sidestand 		Every time vehicle is used									
		•	•	•	•	•	•	•	•	•	•
Side stand switch 		Every time vehicle is used									
		•	•	•	•	•	•	•	•	•	•
Swingarm bearings 								•			



Tables of scheduled maintenance

(*): The mileage coupons can be carried along with the **mandatory annual coupon**

km (mi) covered*		0	1000 (600)	Every year	15000 (9000)	30000 (18000)	45000 (27000)	60000 (36000)	75000 (45000)	90000 (54000)	105000 (63000)	
Service coupon		Deli- very	A		B	C	D	E	F	G	H	
DESCRIPTION		OPERATION										
Rear wheel hub		Check / Lubricate needle bearing				•	•		•	•		•
		Replace						•			•	
Drive chain pads on swingarm		Check / Replace				•	•	•	•	•	•	•
Drive chain pads on frame plate		Check / Replace				•	•	•	•	•	•	•
Rear shock absorber		Check / Adjust		•	•	•	•	•	•	•	•	•
Front forks 		Check / Adjust		•	•	•	•	•	•	•	•	•
		Renew fork oil					•		•		•	
Evaporative emission control system		Check / replace hoses, connections and canister					•	•	•	•	•	•
		Check / clean hot air inlet on canister					•	•	•	•	•	•
Battery connections		Check and clean				•	•	•	•	•	•	•
Electrical equipment		Check operation	•	•	•	•	•	•	•	•	•	•
Instrument panel		Check operation	Every time vehicle is used									
		Check operation	•	•	•	•	•	•	•	•	•	•



Tables of scheduled maintenance

(*): The mileage coupons can be carried along with the **mandatory** annual coupon

km (mi) covered*		0	1000 (600)	Every year	15000 (9000)	30000 (18000)	45000 (27000)	60000 (36000)	75000 (45000)	90000 (54000)	105000 (63000)
Service coupon		Deli- very	A		B	C	D	E	F	G	H
DESCRIPTION		OPERATION									
Lights / Visual signals		Check operation									
		Check operation / Replace									
Horn		Check operation									
		•	•	•	•	•	•	•	•	•	•
Headlight		Check operation									
		Adjust									
Ignition switch		Check operation									
		•	•	•	•	•	•	•	•	•	•
Locks		Check operation									
		•	•	•	•	•	•	•	•	•	•
Screws and nuts		•	•	•	•	•	•	•	•	•	•
Hose clamps		•	•	•	•	•	•	•	•	•	•
General lubrication		•	•	•	•	•	•	•	•	•	•
General test		•	•	•	•	•	•	•	•	•	•



Tables of scheduled maintenance

(**): The mileage coupons for Dragster SCS clutch are not subject to the **mandatory** annual coupon

km (mi) covered**		0	1000 (600)	Every year	15000 (9000)	30000 (18000)	45000 (27000)	60000 (36000)	75000 (45000)	90000 (54000)	105000 (63000)
Service coupon		Del- very	A		B	C	D	E	F	G	H
DESCRIPTION		OPERATION									
Parking brake (Dragster SCS)		Check operation	Every time vehicle is used								
Hydraulic clutch (Dragster SCS)		Check / Adjust free play	•	•	•	•	•	•	•	•	•
Lined clutch disks (Dragster SCS) **		Replace				•	•	•	•	•	•
Clutch expansion disk (Dragster SCS) **		Check / Reassemble in reverse				•		•		•	
		Replace					•		•		•



1.3. Tools and accessories supplied

Under the passenger seat you can find the following tools:

- 2 Allen wrenches (2,5 mm. - 4 mm hexagon);
- 1 spanner for rear wheel eccentric with extension;
- 1 fuse puller;

Inside the fuse box are also provided the following spare fuses (see §1.13.1):

- 1 fuse (10A);
- 2 fuses (15A);
- 1 fuse (25A).





1.4. Table of lubricants and fluids

<i>Description</i>	<i>Recommended product</i>	<i>Specifications</i>
Engine lubrication oil	Motul 7100 4T 5W40 (*)	SAE 5W40
Coolant	Motul Motocool Factory Line	Product based on monoethyleneglycol Ready to use - Do not add water
Brake and clutch fluid	Motul DOT 3 & 4 Brake Fluid	DOT4
Drive chain lubrication oil	Motul Chain Lube Road	–

* : MV Agusta suggests to refer directly to its authorized dealers in order to purchase the recommended product. The Dragster motorcycle engine has been developed with Motul 7100 4T 5W40 engine oil. If the above described lubricant is not available, MV Agusta suggests to use a fully synthetic engine oil having characteristics equal or better than the ones prescribed in the following standards:

- Consistent with: API SN / SM
- Consistent with: JASO MA2
- SAE Rating: SAE 5W40

NOTE

The above standard denominations must be written, alone or together, on the engine oil container label.





1.5. Checking the engine oil level

Check the oil level while the engine is not running, and has been allowed to cool down for at least ten minutes after a ride.

The check must be performed after placing the motorcycle in an upright position on a horizontal surface.



CAUTION: This operation is best carried out with two people.

Unscrew the oil filler cap and remove it from its seat. Wipe the check dipstick with a clean cloth and fully screw the oil filler cap in its seat, then unscrew it again in order to check the engine oil level.

The level must be between the MAX and MIN marks on the check dipstick connected to the cap. If the oil level is below the MIN mark, top up as described in § 1.5.1.



WARNING: Do not start the engine if the oil level is below the MIN mark.

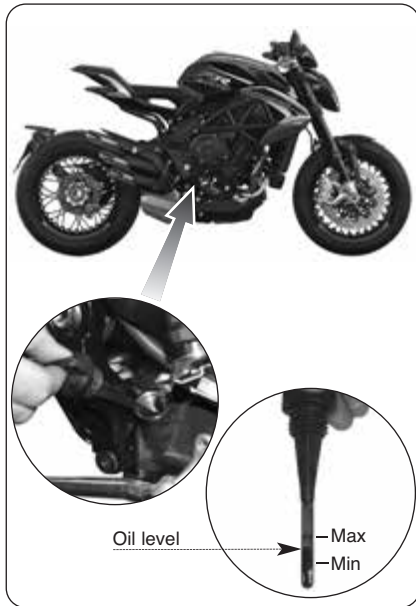



1.5.1. Topping up the engine oil level

Remove the oil filler plug. Pour an appropriate amount of engine oil of the recommended type. Never exceed the MAX level mark. At the end of the operation, place back the oil filler plug.



CAUTION

To avoid clutch sliding and damage to the engine, never add chemical additives to the engine oil, nor use an engine oil different from the one specified in the table at § 1.4. Make sure that no foreign body gets in the crankcase while topping up the engine oil.



**WARNING**

New or exhaust engine oil can be dangerous. Engine oil is highly toxic for people and domestic animals. Avoid ingestion and contact. It has been proved that prolonged contact with engine oil can cause skin cancer on guinea pigs. Even a brief contact with engine oil can cause skin irritation.

- In the event of an engine oil ingestion, immediately call a doctor and do not cause vomiting, in order to avoid inhalation of engine oil in lungs.

- Keep new or exhaust engine oil out of reach of children and domestic animals.
- While topping up the engine oil, wear a long-sleeved shirt and a pair of waterproof gloves to protect your skin.
- If the engine oil comes in touch with your skin, wash it away with soap and water.
- Correctly recycle or dispose of the exhaust engine oil, in order to avoid environmental pollution.



1.6. Checking the coolant level

Check the coolant level while the engine is off and cold. The check must be performed after placing the motorcycle in an upright position on a horizontal surface.

Ensure that the coolant level should be slightly above the MIN mark, as shown in the figure.

If the coolant level is below the MIN mark, top up the coolant as described at paragraph 1.6.1.



WARNING

Do not start the engine if the coolant level is below the MIN mark.

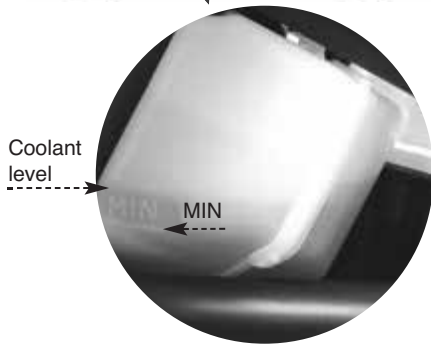



1.6.1. Topping up the coolant level

Unscrew and remove the coolant filler cap. Using a syringe, top up with the recommended coolant (see §1.4).



WARNING: Perform the topping up of the coolant when the engine is off and cold. Never attempt to remove the coolant filler cap when the engine is hot, in order to avoid the risk of burns. The cooling system is under pressure!

After topping up, carefully replace the previously removed parts.



**WARNING**

Under certain conditions, ethylene glycol contained in the coolant can become flammable. When it is lighted, it produces an invisible flame.

Avoid spilling coolant on hot parts of the motorcycle, because the subsequent combustion of ethylene glycol could cause serious burns.

**WARNING**

Coolant is a highly toxic fluid. Avoid ingestion and contact with your skin or eyes. Keep coolant out of reach of children and domestic animals. In the event of a coolant ingestion, immediately call a doctor and do not cause vomiting, in order to avoid inhalation of coolant in lungs. If the coolant comes in touch with your skin or eyes, immediately wash it away with water.

**CAUTION**

To top up the coolant level and/or renew the coolant, use only the product specified in the table at paragraph 1.4. Do not mix nor dilute the coolant with additives or different fluids. If the coolant specified at paragraph 1.4 is not available, use a coolant having technical characteristics consistent with the prescribed product.

**CAUTION**

Coolant can damage painted and plastic parts. When you top up the coolant level, be careful not to spill coolant on any part of the motorcycle. If you do spill coolant on your motorcycle, immediately wipe it away using a clean cloth.



GB 1

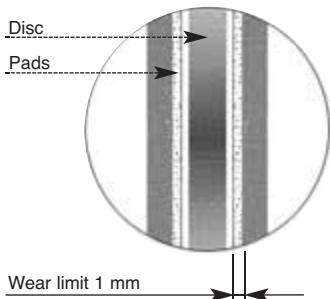

1.7. Checking the wear of the brake pads

Periodically check the width of the friction material layer of the pads, making sure it never falls below the wear limit (1 mm).



WARNING

If the brake pads are excessively worn out, the effectiveness of the braking system decreases, increasing the risk of accidents. If the pads have worn to near the wear limit, have both pads replaced by an authorized service centre. Ensure that the new pads are suitably broken in.



Rear brake fluid reservoir



Front brake fluid reservoir



1.8. Checking the brake fluid level



WARNING

Lack of maintenance of the braking system can increase the risk of accidents. Before riding, always check the braking system according to the instructions below.

The level of the brake fluid decreases as the brake pads wear down. Ensure that the fluid level is always between the MAX and MIN marks. If the level falls below the MIN mark, contact an authorized service centre and have the brake system overhauled.

**WARNING**

Never use your motorcycle if the fluid level is below the MIN mark. The brakes may fail to properly operate, which could lead to an accident. If the brake fluid level is below the MIN mark, you must have the braking system overhauled by an authorized MV Agusta dealer.

**WARNING**

Have the topping up of the brake fluid performed only by skilled personnel. Brake fluid is highly toxic. Avoid contact and ingestion. Keep brake fluid out of reach of children and domestic animals. In the event of a brake fluid ingestion, immediately call a doctor and do not cause vomiting, in order to avoid inhalation of brake fluid in lungs. If the brake fluid comes in touch with your skin or eyes, immediately wash with water.

**WARNING**

Use only the brake fluid specified at paragraph 1.4. of this manual. Mixing different brake fluids can cause a dangerous chemical reaction, as well as the decrease of the braking efficiency, with subsequent increase of the risk of accidents.

**WARNING**

An insufficient amount of brake fluid may allow the introduction of air in the braking system. This could compromise the effectiveness of the braking system, with subsequent increase of the risk of accidents. Presence of air in the braking system can be identified in the moment you feel a characteristic “spongy effect” while pushing the brake lever. In this case, have a braking system bleeding performed by an authorized MV Agusta dealer before riding your motorcycle again.



1.9. Checking the clutch fluid level

The fluid level must be between the MAX and MIN marks.

If the level falls below the MIN mark, contact an authorized service centre and have the clutch control system repaired.

**WARNING**

Never use your motorcycle if the fluid level is below the MIN mark. The clutch may fail to properly operate, which could lead to an accident. If the clutch fluid level is below the MIN mark, have the clutch system overhauled by an authorized MV Agusta dealer.

**WARNING**

Use only the clutch fluid specified in the paragraph 1.4. of this manual.





1.10. Checking and replacing the tyres



WARNING

Before using the motorcycle, always check the pressure and wear of the tyres.

Checking the inflating pressure of the tyres is an essential requirement to ensure driving safety. Insufficiently inflated tyres can reduce the handling of the motorcycle and wear themselves out very quickly. On the other hand, an excessively high inflating pressure reduces the wideness of the surface in contact with the ground, and it can compromise the grip of the vehicle.

Before riding your motorcycle, it is therefore necessary to measure the tyre pressure at room temperature. The vehicle must be parked since three hours at least.



WARNING

An incorrect inflating pressure can lead to dangerous situations during riding. An insufficiently inflated tyre can cause the sliding of the tyre on the wheel rim or its detachment; this may lead to the deflation of the tyre with subsequent loss of control of the vehicle.



In fact, by checking the pressure soon afterwards using the motorcycle, you would obtain a higher value than the actual one. This could cause an incorrect adjustment of the tyre pressure.

Refer to the pressures given in § 3.2. and/or on the label applied on the sleeve of the right front fork. In the event of long travels, you can increase the face value of the tyre pressure of 0.2 bar.

Moreover, it is extremely important to check the wear of the tyres before riding. In fact, a worn out tyre can be punctured more easily than a new one, and it can adversely affect handling and stability of the motorcycle.

Check that the depth of the tyre tread is not below the values prescribed by the Highway Code.

Verify the absence of crevices at the bottom of the tread design and fissures on the tyre sidewall. Moreover, verify the absence of nails and glass splinters in the tyre. If these conditions are not verified, have the tyre replaced by an authorized MV Agusta dealer.

**WARNING**

The limits of the tyre tread depth may vary from country to country. Always refer to the values prescribed by the law provisions of the nation in which you use your motorcycle.

**WARNING**

• If the tyres of your motorcycle are excessively worn out, have it replaced by your MV Agusta dealer. Besides being illegal, riding a motorcycle with excessively worn out tyres can reduce its stability and lead to the loss of control of the vehicle.

• If a tyre is punctured it must be replaced, not repaired. A repaired tyre provides a restricted performance and lower safety levels than a new one.



If you make a provisional or emergency repair to a tyre, you must ride at very low speed until you reach the nearest MV Agusta dealer and have the tyre replaced. With a provisionally repaired tyre, never exceed 60 km/h. Tyre repairing must never be performed if the tyre is punctured on its sidewall, or if the diameter of the puncture on the tread is greater than 6 mm.

- MV Agusta recommends not to use sealing fluids to repair a punctured tyre. These products can adversely affect the material of the tyre layers, as well as hide the minor damages caused by objects penetrated in the tyre.

- When it is necessary to replace the tyres, use only the type specified in paragraph 3.2. Moreover, avoid using tyres of a different brand or type on the front and on the rear wheel at the same time. Using tyres different from those specified can adversely affect the handling and stability of the motorcycle, increasing the risk of accidents.

- The wheel rims of your motorcycle have been designed for use with tubeless tyres only. Do not assemble an air tube tyre on rims designed for tubeless tyres. Otherwise, the tyre bead could not properly settle down on the wheel rim, leading to the deflation of the tyre and the loss of control of the vehicle.



- Do not assemble an air tube on a tubeless tyre. The overheating of the tyre could cause the explosion of the air tube, leading to the deflation of the tyre and the loss of control of the vehicle.
- Have the tyres replaced according to their direction of spin, which is highlighted by a small arrow on the tyre sidewall.

- New tyres should be run in for a short period before demanding their full performance. In fact, during this period the tyres could have a reduced grip on some kind of roads. We suggest to ride at reduced speed and exercise extreme caution during the first 100 km after the replacement of a tyre.

**□ Rear wheel disassembling****CAUTION**

If you have the rear wheel tyre replaced by a tyre-dealer, make sure that the following tools are used in the rear wheel disassembling and reassembling:

- 55 mm polygonal socket wrench
- Torque wrench

If the above mentioned operations are performed with tools other than those indicated, the rear wheel parts can be seriously damaged. Therefore, we strongly recommend not to have the tyres replaced by an improperly equipped workshop. Always have the tyres replaced by an authorized MV Agusta dealer.

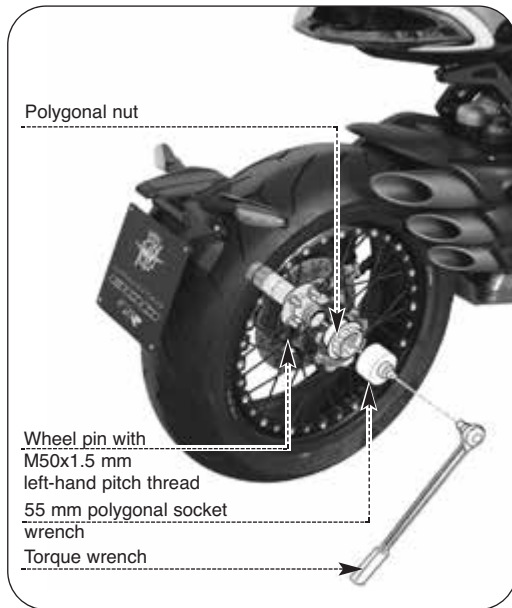



□ Checking the wheel rims

Before riding, always verify the absence of cracks, bending or buckling on the wheel rims.



WARNING

If you find that the wheel rim is damaged, have it replaced by an authorized MV Agusta dealer. Never attempt to repair the wheel rim, even in case of slight damage.

Every time you replace a tyre or a rim, you must have a wheel balancing performed by an authorized MV Agusta dealer. Wheel unbalance can adversely affect performance and handling of the motorcycle, as well as shorten the life of the tyres.



WARNING

When you have a wheel balancing performed, make sure to assemble only approved counterweights on the wheel rim. MV Agusta recommends not to use balancing or balancing/sealing fluids.



WARNING

Do not attempt to have a tubeless tyre removed without using the proper tools and protections for the wheel rim. Otherwise, you could damage the sealing surface of the rim, leading to the deflation of the tyre and the loss of control of the vehicle.



1.11. Checking and lubricating the drive chain

To perform this operation, you must put the motorcycle on the rear stand, upright on a horizontal surface and with the gear in neutral.

□ Checking the chain adjustment



WARNING: Before checking the chain adjustment, contact a MV Agusta authorized centre to verify that the value of the static setup of the rear suspension is correct. Also make sure that the chain is properly lubricated.

The axis of the chain lower portion must be at a distance of **116 mm** from the lower chain guard. Manually turn the rear wheel and carry out the check at several points along the chain. The distance between the chain and the lower chain guard must remain almost constant as the wheel turns. If, on the other hand, the play on the chain varies considerably, it means that some chain links are flattened, seized or elongated. If the distance is greater than 116 mm, have the chain adjusted by your local MV Agusta dealer.

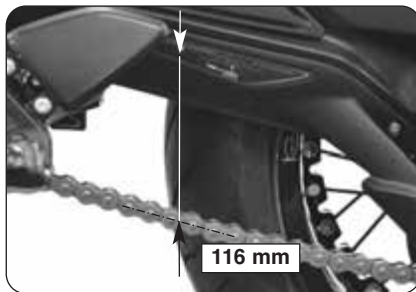

**WARNING**

Riding your motorcycle when the drive chain is in poor condition or improperly adjusted can lead to accidents. Before riding, always check the chain adjustment according to the procedures shown in this paragraph. If necessary, have the chain adjusted by your MV Agusta dealer.

**WARNING**

If any chain link is flattened, seized or elongated, have the chain replaced by a MV Agusta authorized service centre.

**WARNING**

If you notice damage or excessive wear of the chain and the related sprockets, have them replaced by an authorized MV Agusta dealer. Every time the chain is replaced, you must always replace the front and rear sprockets too.

**WARNING**

Using a chain with a fake link can be dangerous. An uncompletely riveted or fake link can accidentally split open and cause accidents, as well as damage to the engine. Never use a chain with a fake link.

**WARNING**

Every time it is requested to operate the rear wheel hub screws, contact an authorized MV Agusta dealer. In order to tighten the screws, apply a tightening torque equal to the value shown in the label placed on the swingarm. Applying a torque higher than the indicated value can cause the fast decay of the rear wheel hub, compromising the reliability of the vehicle and the safety of the pilot and the passenger.



❑ Lubrication

To ensure proper operation, the drive chain needs to be properly lubricated.

► Preliminary cleaning - Before lubrication, the dirt accumulated on the chain must be dissolved using kerosene. The dirt must then be removed with a clean rag and/or an air jet.



CAUTION

The chain is of the O-ring type. To prevent it from damaging, never clean the chain with a steam or high pressure water jet, nor using gasoline or other solvents. The chain must be cleaned using kerosene only.



WARNING

Kerosene is highly toxic and flammable. Avoid contact and inhalation. Keep kerosene away from sparks and flames. Keep kerosene out of reach of children and domestic animals. Correctly dispose of exhaust kerosene, in order to avoid environmental pollution.



► **Lubrication** - Apply a slight and uniform film of lubricant over the whole length of the drive chain, taking care not to smear the surrounding parts, and in particular the tyres. Direct the lubricant jet on the internal links, in order to lubricate the surface of the O-Rings and penetrate inside the chain roller.



CAUTION

Only use the lubricant specified in the paragraph 1.4. of this manual, in order to protect the drive chain and avoid oil spurts when the vehicle is in motion.



WARNING

Chain lubrication must be performed according to the intervals specified in the tables of scheduled maintenance (see § 1.2.). It is also necessary to perform this operation after riding under the rain and after cleaning the motorcycle. Riding your motorcycle when the drive chain is in poor condition or improperly adjusted can lead to accidents.

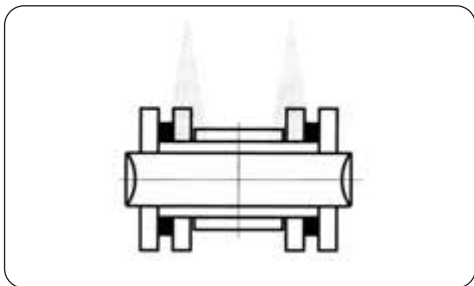

1

CB



GB
1

1.12. Checking the idle speed

Check the idle speed when the engine has reached the operating temperature.

The idle speed should range between 1,250 and 1,350 rpm.

If a tune-up is necessary, contact an authorized service centre.





1.13. Evaporative emission control system

MV Agusta DRAGSTER motorcycles are equipped with an evaporative emission control system which prevents the escape of fuel vapors from the fuel tank. In order to maintain the efficiency and reliability of this device, have the following operations performed by an authorized MV Agusta service center.

Check (and replace if necessary)

Hoses and connections
Canister

Check (and clean if necessary)

Hot air inlet



CAUTION



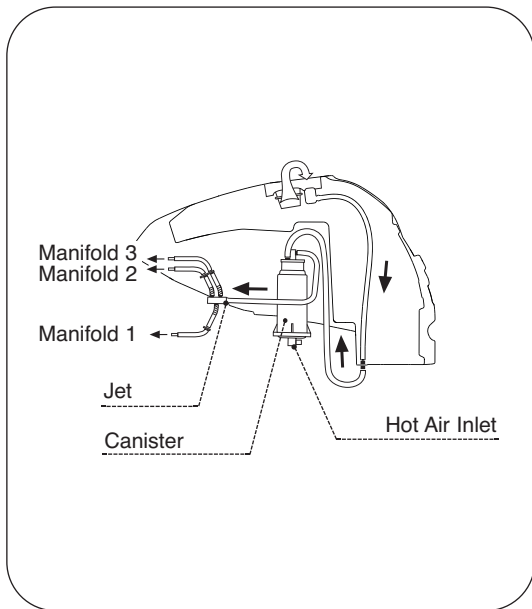





The above mentioned operations must be performed according to the intervals specified in the tables of scheduled maintenance (see § 1.2.).





1.14. Replacing parts - General information

The replacement of the fuses and the light bulbs (except those shown in the table marked ), can be carried out by the owner according to the indications provided below.

	Battery recharge fuse - Replacement (§1.14.1.)
	Fuses - Replacement (§1.14.1.)
	Low beam - Bulb replacement (§1.14.2.)
	High beam - Bulb replacement (§1.14.3.)
	Front and rear turn indicators - Replacement
	License plate light - Replacement
	Tail light - Replacement
	Brake light - Replacement

1.14.1. Replacing the fuses

► The battery recharge fuse is located on the solenoid starter, in the position indicated on the right side of the motorcycle.

To reach them remove the protective cover by removing the two fixing screws.

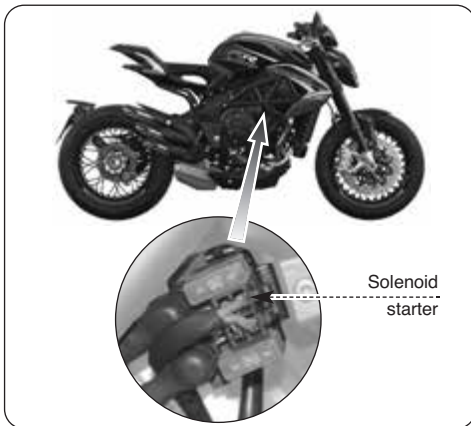



CAUTION

Turn the ignition key on the “OFF” position before checking or replacing the fuses, in order to avoid a short circuit with subsequent damage to other electric parts of the motorcycle.

- ▶ To replace the fuse, you must swap the recharge fuse with the spare fuse.



WARNING

Never replace a fuse with a rating other than that prescribed, in order to avoid damage to the electrical equipment of the motorcycle which could lead to a fire.

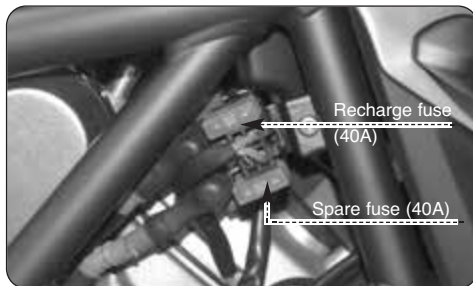



- ▶ The service fuses are located on the right side of the motorcycle.
- ▶ Unfasten and lift the lid of the fuse box.

**CAUTION**

Turn the ignition key on the “OFF” position before checking or replacing the fuses, in order to avoid a short circuit with subsequent damage to other electric parts of the motorcycle.





► To identify the position and function of the fuses, refer to the information provided under the lid of the box and on the attached wiring diagram; the reference letters in the figure correspond to those shown in the diagram.

Remember that the fuse box contains four spare fuses.

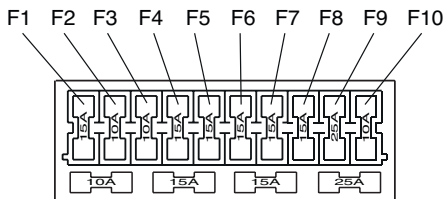

1 CB

► Replace the blown fuse and refit the cover.



WARNING

Never replace a fuse with a rating other than that prescribed, in order to avoid damage to the electrical equipment of the motorcycle which could lead to a fire.





1.14.2. Replacing the low beam bulb

► Remove the four fixing screws of the headlight (two on the right side and two on the left side of the bike).



► Before removing the headlight from the vehicle, detach the connector on the rear side of the headlight and the connectors of the front turn indicators.

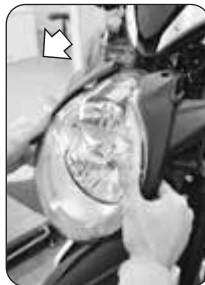



- ▶ Place the headlight on a table in order to be able to perform the following operations.
- ▶ Remove the protective cap.
- ▶ Rotate the connector of the low beam bulb counter-clockwise.
- ▶ Extract the bulb.
- ▶ Detach the bulb connectors.



CAUTION: Do not touch the bulb glass with bare hands. If you do, clean the bulb with an oil-free solvent.

- ▶ Replug the bulb connectors on the new bulb.
- ▶ Insert the new bulb.
- ▶ Rotate the connector clockwise.
- ▶ Reposition the protective headlight cover, making sure to correctly place its timing reference.
- ▶ Reattach the headlight connector and the front turn indicators connectors.
- ▶ Replace the headlight on the vehicle and insert the four fixing screws, making sure to insert the cables in the lateral seats.

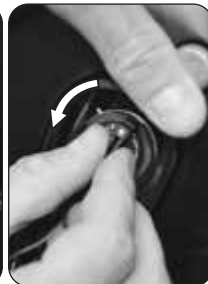

1
CB

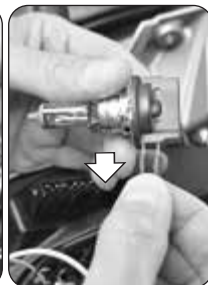



1.14.3. Replacing the high beam bulb

- ▶ Remove the headlight from the bike as described at §1.14.2.
- ▶ Release the retaining spring of the high beam bulb.
- ▶ Extract the bulb.
- ▶ Detach the bulb connector.



CAUTION: Do not touch the bulb glass with bare hands. If you do, clean the bulb with an oil-free solvent.

- ▶ Replug the bulb connector on the new bulb.
- ▶ Insert the new bulb, making sure to correctly place its timing references.
- ▶ Reattach the spring.
- ▶ Reassemble the headlight on the bike as described at §1.14.2.

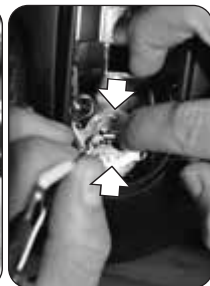



1.15. Battery

The battery is of the maintenance-free type and is installed under the fuel tank. This battery does not require checking of the fluid level or adding of distilled water.

If the battery seems to be run-down (causing electrical problems or a difficult starting), recharge it as soon as possible by connecting the charger to the present connector under the passenger seat. Remember that the battery runs down more quickly if your motorcycle is equipped with additive electrical accessories.



WARNING

If the battery casing is damaged, there may be a leakage of sulphuric acid, a **HIGHLY TOXIC AND CORROSIVE** substance. Avoid any contact with your eyes, skin and clothes. Always wear protective glasses when you have to work near the battery.

In the event of a contact with sulphuric acid, give the **FIRST AID** as described below:

- **CONTACT WITH EYES:** Wash away with water for about 15 minutes, and immediately call a doctor.
- **CONTACT WITH SKIN:** Wash away with a great amount of water.
- **INGESTION:** Drink great amounts of water or milk, and immediately call a doctor.

Furthermore, leakage of sulphuric acid can result in the formation of hydrogen gas which, if ignited by a spark or a flame, would cause an explosion.

Always have the battery replaced by your local MV Agusta dealer.



GB
1

Prolonged inactivity

If the motorcycle is to remain unused for a long time (a month or longer), it is advisable to remove the recharging fuse (see §1.14.1). In case of prolonged inactivity, it is recommended to recharge the battery once a month, in order to ensure durability.

To do this connect the charger on the connector placed under the passenger seat, with the recharging fuse inserted in the solenoid starter.

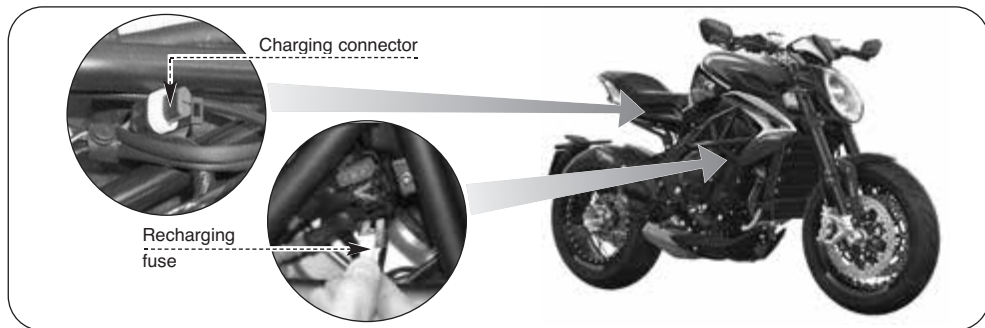



1.16. Cleaning the motorcycle

Periodic careful cleaning is a key factor in preserving the value of the motorcycle, protecting its surface finish and checking for damages, wear and leakage of corrosive fluids.



CAUTION

Before washing the vehicle, stop up the exhaust pipes and protect the electrical parts.



WARNING

Do not wash your motorcycle soon afterwards riding. Attend a few minutes to allow the engine and the exhaust pipes to thoroughly cool.



CAUTION: Never use washing systems involving steam or high pressure water jets. These systems could cause water infiltration and damage the internal parts of your motorcycle.



INFORMATION: Spilling detergent can cause environmental pollution. Therefore, you should clean your motorcycle in an area equipped for collection and disposal of washing fluids.



Wash the motorcycle with water, a mild detergent and a sponge. Wipe the vehicle with a soft cloth. Use an air jet to dry difficult-to-reach areas.

**CAUTION**

- Avoid using clothes or sponges that have been in contact with strong or abrasive detergents, solvents, alcohol or gasoline.
- To avoid irreparable damage to the bodywork parts, never use alkaline or strongly acid detergents, petrol, brake fluid or other solvents.
- If you have doubts about the chemical composition of the detergent, test its effect by applying it on a little area of the bodywork before using it on the whole bike.

Periodically treat the paintwork with high quality wax. After riding on roads treated with corrosive substances (salt), wash the vehicle as soon as possible with cold water. Do not use hot water as it enhances the corrosive action.

**WARNING**

Avoid smearing brakes or tyres with oil or wax. If necessary, clean the brake discs with a brake disc detergent or with acetone, and wash the tyres with warm water and a neutral detergent.

**WARNING**

The presence of water on the brakes can lead to a decrease of the braking effectiveness with subsequent risk of accidents. After completing the washing, run the engine for a few minutes and start off at reduced speed. Carefully apply the brakes a few times so as to dry the brake pads and discs.

**WARNING**

The drive chain must be correctly lubricated after washing the motorcycle, following the instructions provided at § 1.11. of this manual.



1.17. Prolonged inactivity

If the motorcycle is to remain unused for a long time, it is advisable to carry out the following operations:

	Empty the fuel tank.
	Remove the recharge fuse (§1.14.1). Recharge the battery every month. (§1.15.).
	Remove the spark plug caps and the spark plugs. Pour a teaspoonful of engine oil in every spark plug hole, then place back the spark plugs and the corresponding caps. Make the engine run idle for a few times.
	Lubricate all control cables and the joints of all pedals and levers.
	Clean the motorcycle and treat the paintwork with high quality wax (§1.16.).
	In order to ensure integrity and performance of the tyres, park your motorcycle in a fresh, dry and dark place, with a temperature relatively constant and lower than 25° C. Avoid direct contact of the tyres with heating pipes or radiators, and prolonged contact with oil or gasoline. Avoid parking with the tyres near to electrical motors or devices capable to produce sparks or electric discharge. During the period of inactivity, place your motorcycle on the rear stand.
	Cover the vehicle with an adequate canvas cover.

When the motorcycle is first put back into service, remember to carry out a comprehensive check and, if necessary, to have the vehicle serviced (§1.2.).



2.1. Diagnostic connector position

The connector for the diagnostic software is placed under the driver's saddle. To access the connector, it is necessary to remove the saddle as described in paragraph §4.6. of the User's Manual.

In order to ensure the hardware connection, it is necessary to connect the appropriate interface cable (to be ordered through MV Agusta Spare Parts Service) to the diagnostic connector.

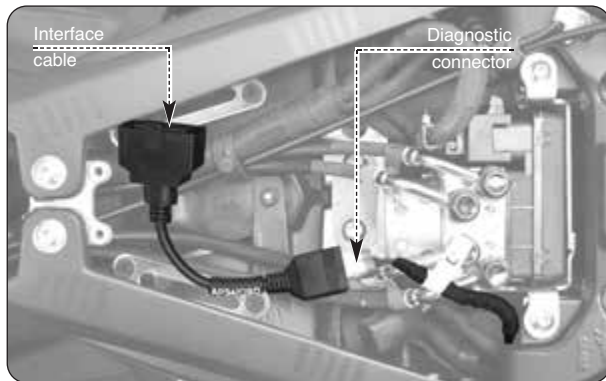

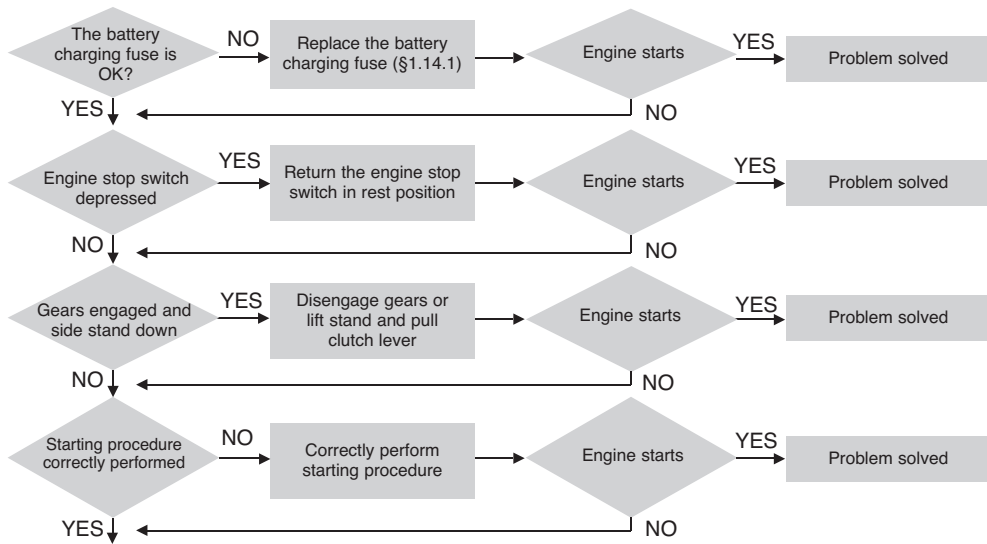
**2.2. Engine problems: ENGINE DOES NOT START**

continued on next page



continued from previous page

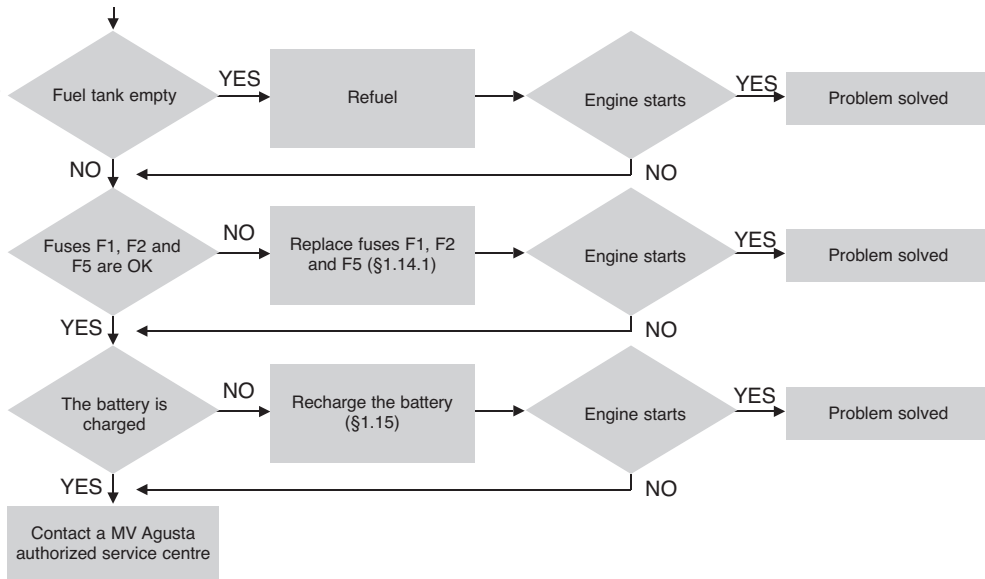



ENGINE SHUTS OFF DURING RIDING

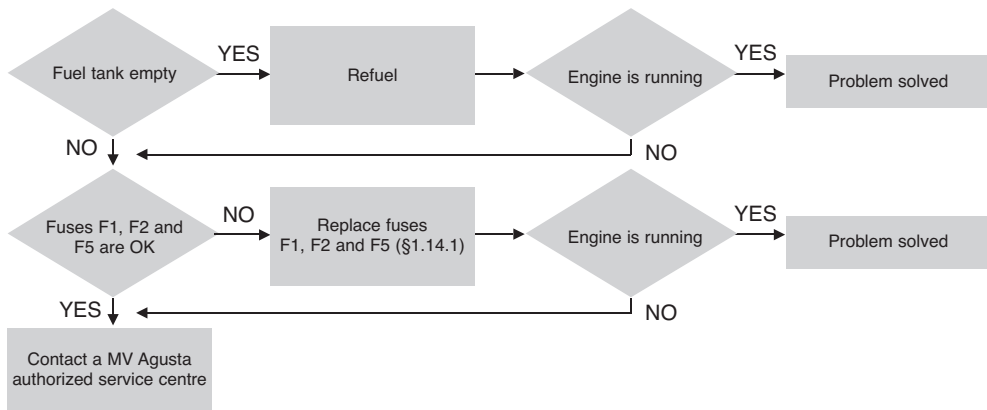



ENGINE OVERHEATS

GB
2

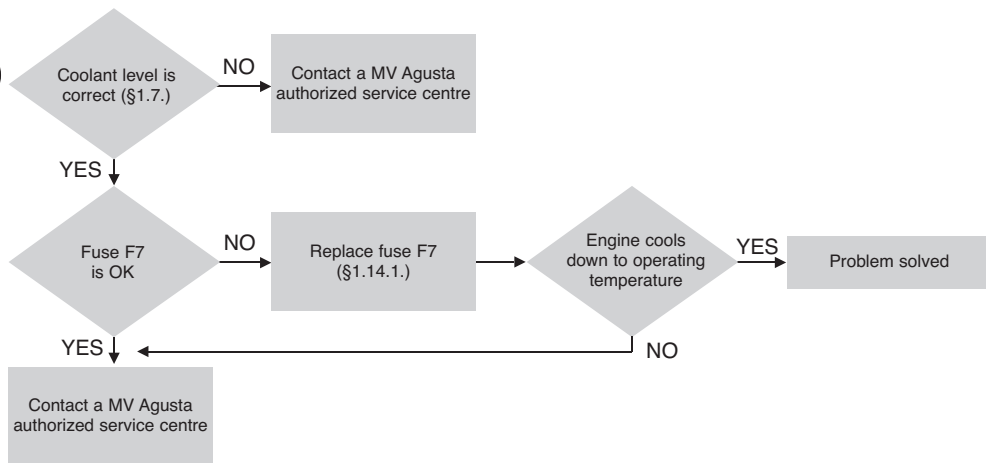



OIL PRESSURE IS TOO LOW (Engine oil pressure warning light is on with the engine running)

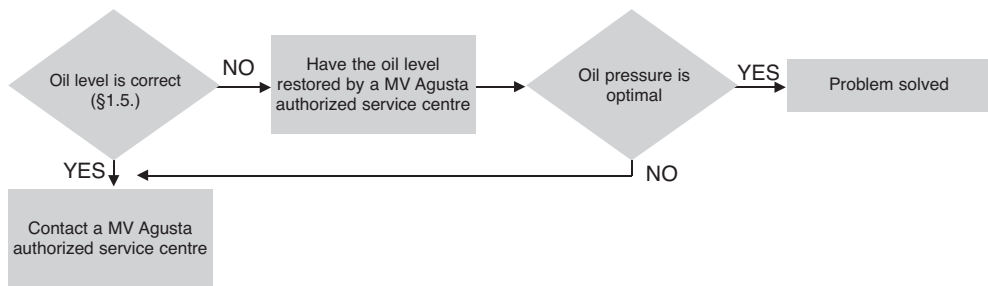



2.3. Electrical equipment problems: **LIGHTS DO NOT WORK**

GB
2

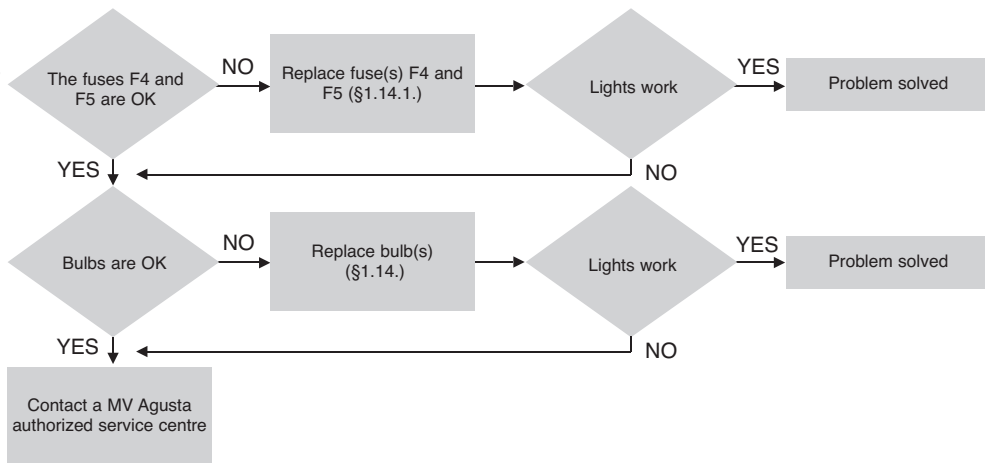



HORN DOES NOT WORK

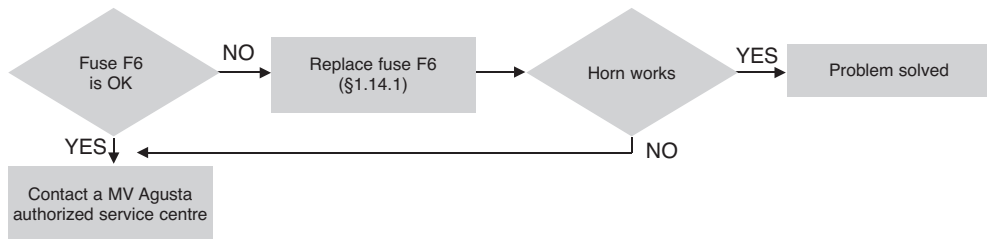

2 GB

DASHBOARD DOES NOT WORK

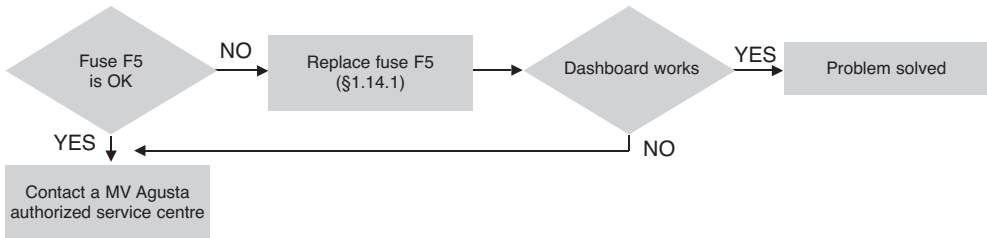



3.1. Motorcycle overview

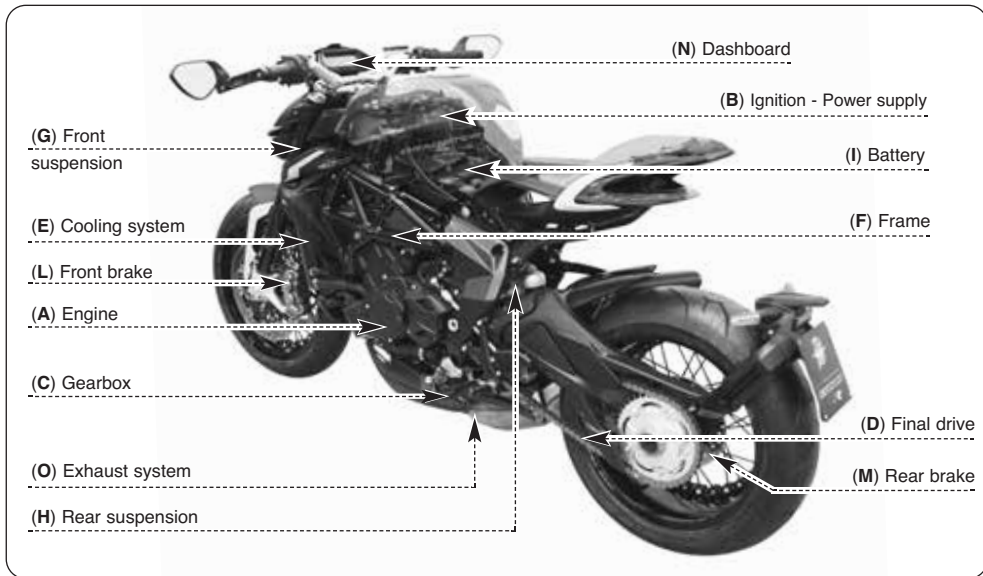



- A - Engine:** four-stroke, inline three-cylinder. Double-overhead camshaft valve train. Wet sump lubrication.
- B - Ignition - Power supply:** integrated ignition-injection system. Inductive-discharge electronic ignition. "Multipoint" electronic injection.
- C - Gearbox:** removable, six-speed, with constant-mesh gears.
- D - Final drive:** consisting of drive sprocket, rear sprocket and chain.
- E - Cooling system:** with separate liquid and oil radiators.
- F - Frame:** tubular steel trellis with aluminium side plates.
- G - Front suspension:** upside-down hydraulic fork with external adjusting system.
- H - Rear suspension:** progressive, with single-sided swingarm and single shock absorber with external adjusting system.
- I - Battery:** sealed and maintenance-free.
- L - Front brake:** dual semi-floating disc with four-piston calipers.
- M - Rear brake:** single disc with two-piston caliper.
- N - Instrument panel:** with warning lights and digital instruments.
- O - Exhaust system:** equipped with catalytic converter for exhaust emission reduction.



3.1.1. Braking system (ABS)

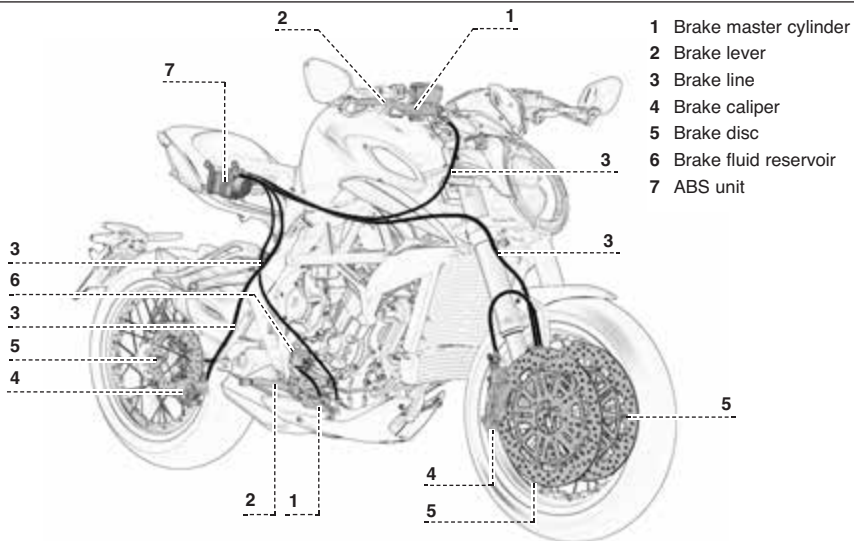



3.1.2. Engine lubrication

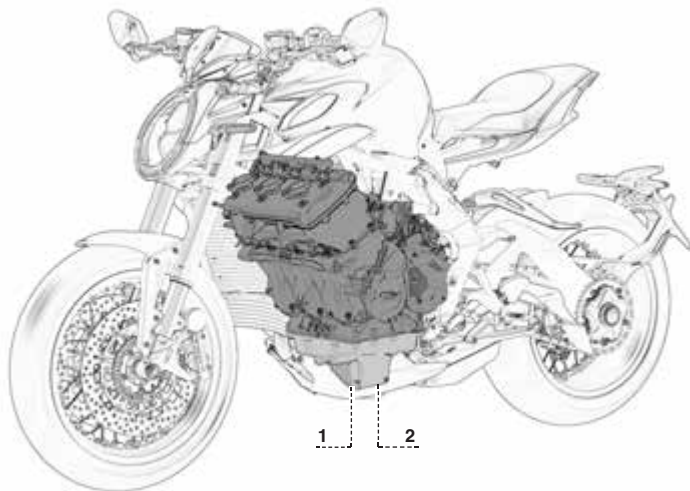

- 1 Oil sump
- 2 Oil filter



3.1.3. Coolant circuit

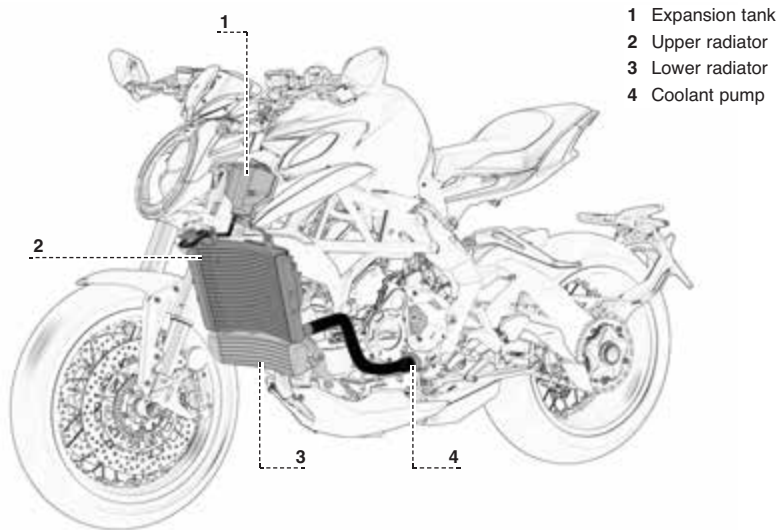



3.1.4. Fuel system

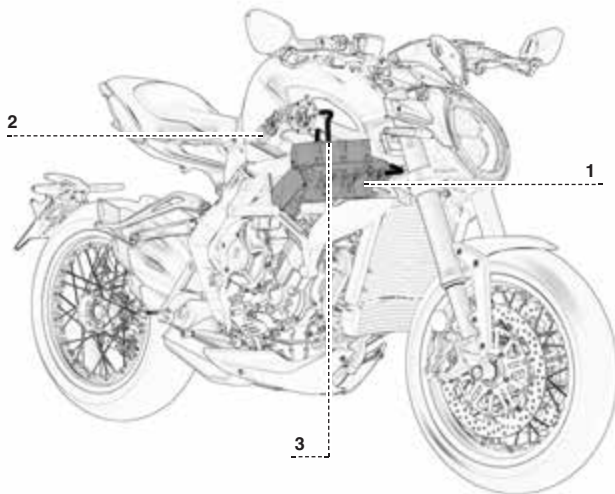

- 1 Throttle bodies
- 2 Fuel pump
- 3 Fuel line



3.2. Specifications

Description	Dragster 800 Rosso	Dragster RR / RR SCS	Dragster RC / RC SCS
SPECIFICATIONS			
Wheelbase (mm) (*)	1400	1400	1400
Overall length (mm) (*)	2035	2035	2035
Max. width (mm)	935	935	935
Seat height (mm) (*)	845	845	845
Min. ground clearance (mm) (*)	135	135	135
Trail (mm) (*)	103.5	103.5	103.5

*: The indicated values must not be intended as binding informations. They can change according to the vehicle setup.



Specifications

Description	Dragster 800 Rosso	Dragster RR / RR SCS	Dragster RC / RC SCS
Dry weight (kg)	168	168	168
Fuel tank capacity (l) (*)	16.5	16.5	16.5
Reserve fuel (l) (*)	4	4	4
Oil in crankcase (kg)	2.5	2.5	2.5
ENGINE			
Type	Three-cylinder, four-stroke, 12 valves		
Bore (mm)	79.0	79.0	79.0
Stroke (mm)	54.3	54.3	54.3
Total displacement (cm ³)	798	798	798
Compression ratio	12.3 : 1	13.3 : 1	13.3 : 1
Environmental standard	Euro 4	Euro 4	Euro 4
CO ₂ emissions (g/km)	128	163	163
Fuel consumption (l/100 km)	5.6	6.7	6.7
Starting	Electric starter		
Cooling system	Cooling with separate liquid and oil radiators		
Crankcase and covers	Die-cast		
Head and cylinders	Chill-cast		
Valves	Steel		

* : The indicated data must not be intended as binding informations. They can change according to the environmental temperature, the engine temperature and the evaporation point of the gasoline.



Specifications

Description	Dragster 800 Rosso	Dragster RR / RR SCS	Dragster RC / RC SCS
VALVE TRAIN			
Type	Double-overhead camshaft		
LUBRICATION			
Type	Wet sump		
IGNITION - POWER SUPPLY			
Type	Integrated ignition-injection system MVICS. Engine control unit Eldor EM2.0; throttle body full drive by wire Mikuni; pencil-coils with ion-sensing technology, control of detonation and misfire. Torque control with 4 mappings; Traction Control with 8 levels of intervention.		
Number of injectors	3	6	6
Spark plugs	NGK CR9 EIB-9	NGK CR9 EIB-9	NGK CR9 EIB-9
Spark gap (mm)	0.8 ÷ 0.9	0.8 ÷ 0.9	0.8 ÷ 0.9
CLUTCH			
Type	Multiple-disc in oil bath - Hydraulic control with mechanical anti-surgng device		
PRIMARY DRIVE			
Number of teeth on countershaft gear	Z = 22	Z = 22	Z = 22
Number of teeth on clutch gear	Z = 41	Z = 41	Z = 41
Transmission ratio	1.864	1.864	1.864
SECONDARY DRIVE			
Number of teeth on front sprocket	Z = 16	Z = 16	Z = 16
Number of teeth on rear sprocket	Z = 41	Z = 41	Z = 41
Transmission ratio	2.563	2.563	2.563



Specifications

Description	Dragster 800 Rosso	Dragster RR / RR SCS	Dragster RC / RC SCS
TRANSMISSION			
Type	Removable, six-speed gearbox with constant-mesh gears		
Gear ratio (overall ratios)			
First gear	2.846 (13.593)	2.846 (13.593)	2.846 (13.593)
Second gear	2.187 (10.447)	2.125 (10.149)	2.125 (10.149)
Third gear	1.778 (8.635)	1.778 (8.635)	1.778 (8.635)
Fourth gear	1.500 (7.165)	1.579 (7.541)	1.579 (7.541)
Fifth gear	1.318 (6.295)	1.429 (6.823)	1.429 (6.823)
Sixth gear	1.190 (5.684)	1.318 (6.295)	1.318 (6.295)
FRAME			
Type	ALS steel tubular trellis (MAG welded)		
Swingarm pivot plates	Aluminium alloy		
FRONT SUSPENSION			
Type	"Upside down" telescopic hydraulic fork with external and separated adjustment of rebound and compression damping and of spring preload		
Rod diameter (mm)	43	43	43
Travel on leg axis (mm)	125	125	125
REAR SUSPENSION			
Type	Progressive, single shock absorber with extension, compression and spring preload adjustment		
Swingarm	Aluminium alloy		
Wheel travel (mm)	124	124	124



Specifications

Description	Dragster 800 Rosso	Dragster RR / RR SCS	Dragster RC / RC SCS
FRONT BRAKE			
Type	Dual floating disc with steel braking band		
Disc diameter (mm)	320		
Disc flange	Steel		
Calipers, piston diameters (mm)	Radial-type, 4-piston (Ø 32)		
REAR BRAKE			
Type	Single steel disc		
Disc diameter (mm)	220		
Caliper, piston diameter (mm)	2-piston (Ø 34)		
FRONT RIM			
Material	Aluminium alloy	Aluminium alloy - Spoke wheel	Forged aluminium alloy
Dimensions	3.50" x 17"	3.50" x 17"	3.50" x 17"
REAR RIM			
Material	Aluminium alloy	Aluminium alloy - Spoke wheel	Forged aluminium alloy
Dimensions	6.00" x 17"	6.00" x 17"	6.00" x 17"
TYRES			
Front	120/70 ZR 17 M/C (58 W)	120/70 ZR 17 M/C (58 W)	120/70 ZR 17 M/C (58 W)
Rear	200/50 ZR 17 M/C (75 W)	200/50 ZR 17 M/C (75 W)	200/50 ZR 17 M/C (75 W)



Specifications

Description	Dragster 800 Rosso	Dragster RR / RR SCS	Dragster RC / RC SCS
Brand and type	PIRELLI Diablo Rosso II	PIRELLI Diablo Rosso II	PIRELLI Diablo Rosso II
Inflating pressure (*):			
Front	2.5 bar (36 psi)	2.5 bar (36 psi)	2.5 bar (36 psi)
Rear	2.8 bar (41 psi)	2.8 bar (41 psi)	2.8 bar (41 psi)
ELECTRICAL EQUIPMENT			
Equipment voltage	12 V		
Low beam	H11B 12V 55W		
High beam	H3 12V 55W		
Turn indicators	LEDs		
Tail light	LEDs		
Brake, rear light	LEDs		
Battery	12 V - 8,6Ah		
Alternator	350 W at 5000 rpm		
BODYWORK			
Fuel tank	Thermoplastic material		
Fuel tank side panels	Thermoplastic material	Thermoplastic material	Carbon fiber
Rear side panels	Thermoplastic material		

* : If you use tyres of a brand different from the ones recommended, refer to the inflating pressure values marked by the manufacturer on the tyre sidewall.



Specifications

Description	Dragster 800 Rosso	Dragster RR / RR SCS	Dragster RC / RC SCS
Dashboard cover	Thermoplastic material	Thermoplastic material	Carbon fiber
Rear mudguard	Thermoplastic material	Thermoplastic material	Carbon fiber
Front mudguard	Thermoplastic material		
Front mudguard supports	Thermoplastic material	Thermoplastic material	Carbon fiber
Air box side panels	Thermoplastic material		
Chain guards	Thermoplastic material		
License-plate holder	Thermoplastic material		
Rearview mirrors	Thermoplastic material		
Exhaust pipe guard	Aluminium		
Radiator side covers	Thermoplastic material		





GB 3





3.3. Bodywork parts reference colours (Dragster 800 Rosso)

Bodywork parts are painted with the following reference colours:

1. - Fuel tank:

F4 Ago Red
(Code Palinal 926R750)

- 2. - Right hand central fairing;
- 3. - Left hand central fairing;
- 4. - Right hand front fairing;
- 5. - Left hand front fairing;
- 6. - Right hand rear fairing;
- 7. - Left hand rear fairing:

Metal Carbon Black
(Code Palinal 928.V311)



GB 3





3.4. Bodywork parts reference colours (Dragster RR / RR SCS MY20)

Bodywork parts are painted with the following reference colours, according to the corresponding motorcycle colour combination:

1. - Fuel tank:

- **Colour code A:**

Night Grey

(Code Lechler LCH29902-662) +

Metal Carbon Black

(Code Palinal 928.V311)

- **Colour code B:**

ICE Pearly White

(Code Lechler 2902181) +

Metal Carbon Black

(Code Palinal 928.V311)

2. - Right hand central fairing;

3. - Left hand central fairing:

Metal Carbon Black

(Code Palinal 928.V311)

4. - Right hand front fairing;

5. - Left hand front fairing;

6. - Right hand rear fairing;

7. - Left hand rear fairing:

- **Colour code A:**

Pearly Metal Yellow

(Code Lechler LCC00997 +

Lechler LCC00998)

- **Colour code B:**

Neon Green

(Code Lechler BDCR216)



GB
3





3.5. Bodywork parts reference colours (Dragster RC / RC SCS MY20)

Bodywork parts are painted with the following reference colours:

1. - Fuel tank;
2. - Right hand front fairing;
3. - Left hand front fairing:

Metal Avio Grey
(Code Palinal 928.T892) +
Metal Carbon Black
(Code Palinal 928.V311)

4. - Front mudguard;
5. - Right hand airbox fairing;
6. - Left hand airbox fairing;
7. - Right hand rear fairing;
8. - Left hand rear fairing:

Metal Avio Grey
(Code Palinal 928.T892)



GB
3

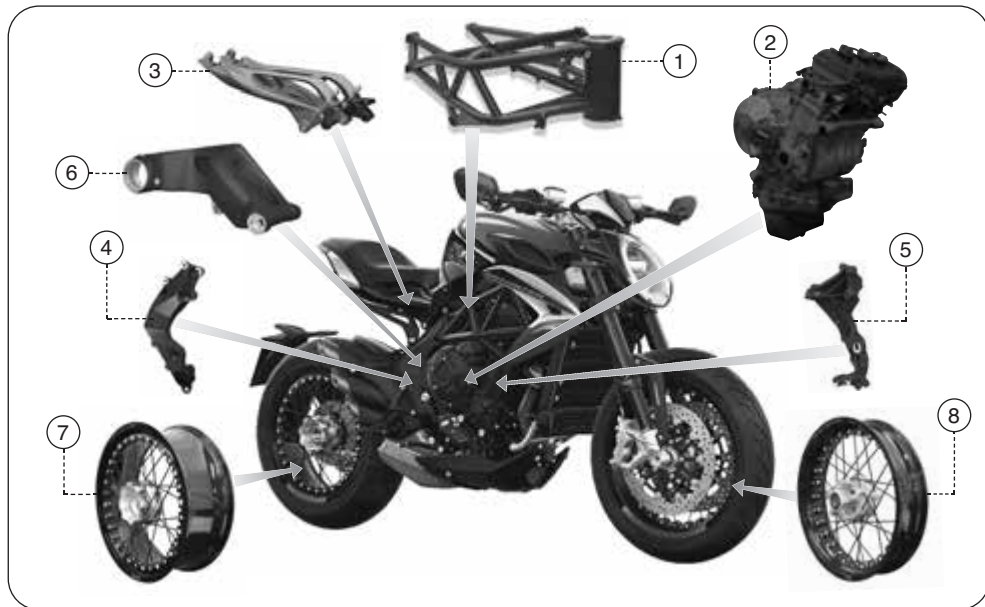



3.6. Frame parts reference colours

Frame parts are painted with the following reference colours:

1. - Frame:

- **Dragster 800 / RR / RR SCS MY20:**
Gloss Black (Code PPG PCU 90207)
- **Dragster RC / RC SCS MY20:** Frame
Red (Code Akzo Nobel QG000K Red)

3. - Rear Frame;

4. - Right-hand frame plate;

5. - Left-hand frame plate;

6. - Rear swingarm:

Quasar Black
(Code Inver 61196 - Poliest/HD TGIC Free)

2. - Engine:

Matt Black
(Code Pulverit 3500/0085)

7. - Rear wheel rim;

8. - Front wheel rim:

- **Dragster 800 Rosso:** Gloss Black
(Code Peter Lacke VPCH03250)
- **Dragster RR / RR SCS MY20:**
Gloss Black
- **Dragster RC / RC SCS MY20:**
Gloss Red (Code Da Qiao
WFMY-S09-Q + WFMY-S10-Q)



Information

MV Agusta Motor S.p.A. is committed to a policy of constant improvement; therefore, you may find slight differences between the information provided in this document and the vehicle you purchased. MV Agusta motorcycles are exported in several countries, in which different rules and regulations (concerning both the Highway Code and the homologation procedures) are in force. Relying on your understanding, MV Agusta Motor S.p.A. deems it necessary to reserve the right to change its products and the related documentation at any time and without notice.

We suggest to often visit the Internet site www.mvagusta.com in order to obtain informations and updates about the MV Agusta products and the related documentation.



Respect and defend natural environment

Everything we do affects the whole planet as well as its resources.

MV Agusta, in order to protect the interests of the community, awakens the Customers and the Technical Assistance operators to use the vehicle and dispose of its replaced parts respecting the laws in force concerning environmental pollution and waste disposal and recycling.

© 2020

This document may not, in whole or in part, be reproduced without prior consent, in writing, from MV Agusta Motor S.p.A.

Part. n° 8000C8714

Edition n° 1 - January 2020

MV AGUSTA

**DRAGSTER
EIGHTHOUR**



Manuel d'entretien
Version Française



TABLE DES MATIÈRES

<i>Chap.</i>	<i>Sujets abordés</i>	<i>page</i>
1	ENTRETIEN	3
1.1.	Symboles	3
1.2.	Tableau d'entretien et contrôle	4
1.3.	Outils et accessoires équipant la moto	14
1.4.	Tableau des lubrifiants et liquides	15
1.5.	Huile moteur - Contrôle du niveau	16
1.5.1.	Huile moteur - Appoint	17
1.6.	Liquide de refroidissement - Contrôle	19
1.6.1.	Liquide de refroidissement - Appoint	21
1.7.	Plaquettes de freins - Contrôle usure	22
1.8.	Liquide de freins - Contrôle du niveau	23
1.9.	Liquide d'embrayage - Contrôle du niveau	25
1.10.	Pneumatiques - Contrôle et remplacement	26
1.11.	Chaîne - Contrôle et lubrification	32
1.12.	Régime du ralenti - Contrôle	36
1.13.	Système de contrôle des émissions de vapeur	37
1.14.	Remplacements - Informations générales	38
1.14.1.	Fusibles - Remplacement	38
1.14.2.	Feu de croisement - Remplacement ampoule	42
1.14.3.	Feu de route - Remplacement ampoule	44
1.15.	Batterie	45
1.16.	Nettoyage de la moto	47
1.17.	Période d'arrêt prolongé	49

<i>Chap.</i>	<i>Sujets abordés</i>	<i>page</i>
2	PANNES	50
2.1.	Position du connecteur de diagnostic	50
2.2.	Problèmes au moteur	51
2.3.	Problèmes de nature électrique	56
3	INFORMATIONS TECHNIQUES	58
3.1.	Description générale de la moto	58
3.1.1.	Système de freinage (ABS)	60
3.1.2.	Graissage moteur	61
3.1.3.	Circuit de refroidissement	62
3.1.4.	Circuit d'alimentation	63
3.2.	Données techniques	64
3.3.	Référence couleurs des superstructures (Dragster 800 Rosso)	72
3.4.	Référence couleurs des superstructures (Dragster RR / RR SCS MY20)	74
3.5.	Référence couleurs des superstructures (Dragster RC / RC SCS MY20)	76
3.6.	Référence couleurs composants du châssis et de la partie cycle	78



1.1. Symboles

Les parties du texte particulièrement importantes qui concernent la sécurité de la personne et l'intégrité de la moto, sont mises en évidences par les pictogrammes suivants:



Danger - Attention: Le non respect partiel ou total de ces prescriptions peut être source de danger pour soi-même et pour autrui.



Prudence - Précautions: Le non respect partiel ou total de ces prescriptions peut être cause de dommages pour la moto.

Pour indiquer les personnes autorisées à exécuter les opérations de réglage et/ou d'entretien, celles-ci sont mises en évidences par les pictogrammes suivants:



Informations sur les opérations permises au motard.



Informations sur les opérations qui doivent être effectuées uniquement par le personnel autorisé.

Pour mettre en évidence les informations supplémentaires, les symboles suivants sont utilisés:



Le symbole  indique la nécessité d'utiliser un outil ou un appareil spécial pour l'exécution correcte de l'opération décrite.



Le symbole “§” renvoie au chapitre correspondant au numéro qui l'accompagne.



1.2. Tableau d'entretien et contrôle

Les opérations d'entretien et contrôle les plus importantes et leur fréquence, sont indiquées dans les tableaux correspondants. Il est indispensable d'effectuer ces opérations pour garder la moto efficace et sûre.

Les intervalles indiqués dans le tableau d'entretien périodique et de lubrification doivent être considérés uniquement comme un guide général en conditions d'utilisation normales. Il pourrait être nécessaire de réduire ces intervalles en fonction des conditions climatiques, du terrain, de la situation géographique et de l'utilisation individuelle.

Certaines opérations peuvent être effectuées par le propriétaire de la moto, à condition qu'il soit en possession des compétences nécessaires. Dans le cas contraire, faire effectuer les opérations par un centre de réparation agréé.

En général, les opérations d'entretien s'effectuent avec la moto montée sur la béquille arrière, avec le moteur coupé et le coupe-circuit sur "OFF". Pendant le contrôle du niveau de liquide, il est préférable de tenir la moto en position verticale sans utiliser la béquille arrière.

Au delà de 105.000 km (63000 mi), les opérations s'effectuent à la fréquence indiquée dans le tableaux.



ATTENTION

- Un entretien inadéquat ou la non exécution des travaux d'entretien conseillés, augmente le risque d'accident ou de détérioration de la moto
- Utiliser toujours des pièces détachées d'origine MV Agusta. L'utilisation de pièces non d'origine peut accélérer l'usure de la moto et écourter sa durée de vie.
- La non exécution des opérations recommandées ou l'utilisation de pièces détachées non d'origine a pu rendre la garantie inadmissible.
- Le remplacement et/ou le rétablissement des lubrifiants et des liquides s'effectue en utilisant exclusivement les produits indiqués au §1.4.



ATTENTION

En cas d'utilisation sur piste, il est recommandé de faire contrôler la moto avant et après l'emploi par un personnel qualifié faisant partie du réseau des Centres d'Assistance MV Agusta.

L'utilisation sur piste n'est admise que de manière occasionnelle et en aucun cas à des fins de compétition, même à un niveau d'amateur.

L'utilisation de la moto sur piste entraîne une usure notable des pièces, et par là une réduction de la durée de vie du véhicule par rapport à une utilisation normale sur route ou auto-route.



Tableau d'entretien programmé

(*): Les coupons de kilométrage peuvent être effectués avec le coupon annuel **obligatoire**

Fréquence d'entretien km (mi) *		0	1000 (600)	Tous les ans	15000 (9000)	30000 (18000)	45000 (27000)	60000 (36000)	75000 (45000)	90000 (54000)	105000 (63000)
Révision		Livraison	A	B	C	D	E	F	G	H	
DESCRIPTION		OPÉRATION									
Unité de contrôle moteur			•	•	•	•	•	•	•	•	•
Huile moteur		Avant chaque utilisation du véhicule									
		•									
			•	•	•	•	•	•	•	•	•
Filtre à huile moteur		A chaque vidangée									
Liquide de refroidissement		Avant chaque utilisation du véhicule									
		•	•	•	•	•	•	•	•	•	•
		Tous les 2 ans									
Circuit de refroidissement		•	•	•	•	•	•	•	•	•	•
Electroventilateur		•	•	•	•	•	•	•	•	•	•
Soupapes						•		•		•	
Chaîne de distribution											•



Tableau d'entretien programmé

(*): Les coupons de kilométrage peuvent être effectués avec le coupon annuel **obligatoire**

Fréquence d'entretien km (mi) *		0	1000 (600)	Tous les ans	15000 (9000)	30000 (18000)	45000 (27000)	60000 (36000)	75000 (45000)	90000 (54000)	105000 (63000)
Révision		Livraison	A	B	C	D	E	F	G	H	
DESCRIPTION		OPÉRATION									
Patin fixe distribution		Remplacement									●
Patin mobile distribution		Remplacement									●
Tendeur de chaîne distribution		Remplacement									●
Bougies		Remplacement				●		●		●	
Filtre à essence		Remplacement				●		●		●	
Papillon		Contrôler / nettoyer les conduits				●		●		●	
		Contrôler capteur de pression				●		●		●	
Filtre à air (Réduire les intervalles quand on roule dans des zones fortement polluées)		Contrôle/Remplacement			●		●		●		●
		Remplacement				●		●		●	
Cylindres		Contrôler la compression				●		●		●	
		Contrôle du niveau	Avant chaque utilisation du véhicule								
Liquide des freins et d'embrayage		Contrôle du niveau	●	●	●	●	●	●	●	●	●
		Remplacement	Minimum tous les 2 ans								



Tableau d'entretien programmé

(*): Les coupons de kilométrage peuvent être effectués avec le coupon annuel **obligatoire**

Fréquence d'entretien km (mi) *		0	1000 (600)	Tous les ans	15000 (9000)	30000 (18000)	45000 (27000)	60000 (36000)	75000 (45000)	90000 (54000)	105000 (63000)
Révision		Livraison	A	B	C	D	E	F	G	H	
DESCRIPTION	OPÉRATION										
Freins/embrayage	Contrôle fonctionnalité	Avant chaque utilisation du véhicule									
	Contrôle fonctionnalité et circuit	•	•	•	•	•	•	•	•	•	•
	Nettoyer zone de contact levier/piston de pompe frein		•	•	•	•	•	•	•	•	•
Flecteur embrayage	Contrôle/Remplacement										•
Plaquettes des freins (avant + arrière)	Contrôle usure	Tous les 1000 Km (600 mi)									
	Contrôle/Remplacement	•		•	•	•	•	•	•	•	•
Canalisations circuit du carburant	Contrôle défauts et fuites		•	•	•	•	•	•	•	•	•
	Remplacement	Minimum tous les 3 ans									
Commande d'accélérateur	Contrôle fonctionnalité	Avant chaque utilisation du véhicule									
	Contrôle fonctionnalité (avec diagnostic TEXA)	•	•	•	•	•	•	•	•	•	•
Flecteur couronne	Contrôle			•							
	Contrôler / serrer l'écrou		•	•							
	Remplacement				•	•	•	•	•	•	•



Tableau d'entretien programmé

(*): Les coupons de kilométrage peuvent être effectués avec le coupon annuel **obligatoire**







Fréquence d'entretien km (mi) *		0	1000 (600)	Tous les ans (9000)	15000 (9000)	30000 (18000)	45000 (27000)	60000 (36000)	75000 (45000)	90000 (54000)	105000 (63000)
Révision		Livrai- son	A	B	C	D	E	F	G	H	
DESCRIPTION		OPÉRATION									
Chaîne de transmission 		Contrôle	Tous les 1000 Km (600 mi)								
		Graissage	Tous les 1000 Km (600 mi) et après conduite sous la pluie								
		Contrôle / Réglage	●	●	●	Dans tous les cas, tous les 1000 Km (600 mi)					
		Graissage	Dans tous les cas, tous les 1000 Km (600 mi)								
		Remplacement			●	●	●	●	●	●	●
Pignon / Rondelle d'arrêt		Contrôle		●	●						
		Remplacement				●	●	●	●	●	●
Couronne		Contrôle		●	●						
		Remplacement				●	●	●	●	●	●
Pneumatiques		Contrôle pression	A chaque utilisation du véhicule dans tous les cas tous les 10 jours								
		Contrôle usure	A chaque utilisation du véhicule dans tous les cas tous les 500 km (300 mi)								
		Contrôle pression	●	●	●	●	●	●	●	●	●
		Contrôle usure		●	●	●	●	●	●	●	●



Tableau d'entretien programmé

(*): Les coupons de kilométrage peuvent être effectués avec le coupon annuel **obligatoire**

















Fréquence d'entretien km (mi) *		0	1000 (600)	Tous les ans	15000 (9000)	30000 (18000)	45000 (27000)	60000 (36000)	75000 (45000)	90000 (54000)	105000 (63000)	
Révision		Livraison	A	B	C	D	E	F	G	H		
DESCRIPTION		OPÉRATION										
Roulements de direction 		Contrôle / Réglage		•		•		•		•		•
		Lubrification					•		•		•	
Jantes 		Contrôle visuel	•	•	•	•	•	•	•	•	•	•
Dans tous les cas à chaque remplacement des pneus												
Rayons des jantes (Dragster RR-SCS) 		Contrôle / Serrage		•	•	•	•	•	•	•	•	•
Au minimum, tous les ans												
Roulements roue avant 		Contrôle				•	•	•		•	•	•
		Remplacement							•			
Béquille latérale		Contrôle fonctionnalité	Avant chaque utilisation du véhicule									
		Contrôle fonctionnalité	•	•	•	•	•	•	•	•	•	•
Contacteur béquille		Contrôle fonctionnalité	Avant chaque utilisation du véhicule									
		Contrôle fonctionnalité	•	•	•	•	•	•	•	•	•	•
Roulements bras oscillant 		Contrôle / Lubrification						•				



Tableau d'entretien programmé

(*): Les coupons de kilométrage peuvent être effectués avec le coupon annuel **obligatoire**

Fréquence d'entretien km (mi) *		0	1000 (600)	Tous les ans	15000 (9000)	30000 (18000)	45000 (27000)	60000 (36000)	75000 (45000)	90000 (54000)	105000 (63000)
Révision		Livraison	A	B	C	D	E	F	G	H	
DESCRIPTION		OPÉRATION									
Moyeu AR		Contrôle / lubrification des douilles à aiguilles			•	•		•			•
		Remplacement					•			•	
Patin chaîne bras oscillant		Contrôle / Remplacement			•	•	•	•	•	•	•
Patin chaîne plateau cadre		Contrôle / Remplacement			•	•	•	•	•	•	•
Amortisseur arrière		Contrôle / Réglage	•	•	•	•	•	•	•	•	•
Fourches avant		Contrôle / Réglage	•	•	•	•	•	•	•	•	•
		Remplacement huile				•		•		•	
Système de contrôle des émissions de vapeur		Contrôle / Remplacement tuyaux, raccords et canister				•	•	•	•	•	•
		Contrôle / Nettoyage entrée d'air chaud sur le canister				•	•	•	•	•	•
Cosses de batterie		Contrôle / Nettoyage			•	•	•	•	•	•	•
Installation électrique		Contrôle fonctionnalité	•	•	•	•	•	•	•	•	•
Appareillage de bord		Contrôle fonctionnalité	Avant chaque utilisation du véhicule								
		Contrôle fonctionnalité	•	•	•	•	•	•	•	•	•



Tableau d'entretien programmé

(*): Les coupons de kilométrage peuvent être effectués avec le coupon annuel **obligatoire**

Fréquence d'entretien km (mi) *		0	1000 (600)	Tous les ans	15000 (9000)	30000 (18000)	45000 (27000)	60000 (36000)	75000 (45000)	90000 (54000)	105000 (63000)
Révision		Livraison	A	B	C	D	E	F	G	H	
DESCRIPTION	OPÉRATION										
Éclairage/signaux visuels	Contrôle fonctionnalité	Avant chaque utilisation du véhicule									
	Contrôle fonctionnalité / Remplacement	•	•	•	•	•	•	•	•	•	•
Avertisseur sonore	Contrôle fonctionnalité	Avant chaque utilisation du véhicule									
	Contrôle fonctionnalité	•	•	•	•	•	•	•	•	•	•
Projecteur	Contrôle fonctionnalité	Avant chaque utilisation du véhicule									
	Réglage	A chaque variation de l'assiette du véhicule									
Contacteur d'allumage	Contrôle fonctionnalité	Avant chaque utilisation du véhicule									
	Contrôle fonctionnalité	•	•	•	•	•	•	•	•	•	•
Serrures	Contrôle fonctionnalité	Avant chaque utilisation du véhicule									
	Contrôle fonctionnalité	•	•	•	•	•	•	•	•	•	•
Vis et écrous	Contrôle/Serrage	•	•	•	•	•	•	•	•	•	•
Colliers serre-tube	Contrôle/Serrage	•	•	•	•	•	•	•	•	•	•
Lubrification générale		•	•	•	•	•	•	•	•	•	•
Essai sur route		•	•	•	•	•	•	•	•	•	•



Tableau d'entretien programmé

(**): Les coupons de kilométrage pour l'embrayage Dragster SCS ne sont pas soumis au coupon annuel **obligatoire**

Fréquence d'entretien km (mi) **		0	1000 (600)	Tous les ans	15000 (9000)	30000 (18000)	45000 (27000)	60000 (36000)	75000 (45000)	90000 (54000)	105000 (63000)
Révision		Livraison	A	B	C	D	E	F	G	H	
DESCRIPTION	OPÉRATION										
Frein de stationnement (Dragster SCS)	Contrôle fonctionnalité	Avant chaque utilisation du véhicule									
Embrayage automatique (Dragster SCS)	Contrôle / Réglage du jeu	•	•	•	•	•	•	•	•	•	•
Disques embrayage garnis (Dragster SCS) **	Remplacement				•	•	•	•	•	•	•
Disque extenseur d'embrayage (Dragster SCS) **	Contrôle / Remonter à l'envers				•		•		•		•
	Remplacement					•		•		•	



1.3. Outils et accessoires équipant la moto

Sous le siège du passager, se trouvent les outils suivants:

- 2 clés maîtresses hexagonales (hexagone de 2,5 mm - 4 mm);
- 1 clé pour excentrique roue arrière et sa rallonge;
- 1 extracteur pour fusibles.

A l'intérieur du boîtier de fusibles sont fournis les fusibles de rechange suivants (voir §1.12.1):

- 1 fusible de 10A;
- 2 fusibles de 15A;
- 1 fusible de 25A.





1.4. Tableau des lubrifiants et liquides

Description	Produit préconisé	Caractéristiques
Huile moteur	Motul 7100 4T 5W40 (*)	SAE 5W40
Liquide de refroidissement	Motul Motocool Factory Line	Produit à base de mono-éthylène glycol - Prêt à l'emploi - Sans adjonction d'eau
Liquide d'embrayage et freins	Motul DOT 3 & 4 Brake Fluid	DOT4
Huile de graissage de la chaîne	Motul Chain Lube Road	-

* : Pour la disponibilité du produit conseillé, MV Agusta conseille de s'adresser directement aux propres concessionnaires autorisés. Le moteur de la motocyclette Dragster a été développé avec l'huile moteur Motul 7100 4T 5W40. Au cas où le lubrifiant décrit ne serait pas possible à trouver, MV Agusta conseille d'utiliser des huiles complètement synthétiques avec des caractéristiques conformes ou supérieures aux normes suivantes:

- Conforme API SN / SM
- Conforme JASO MA2
- Gradation SAE 5W40

NOTE

Les caractéristiques indiquées ci-dessus doivent être indiquées seules ou avec d'autres sur l'emballage de l'huile.





1.5. Huile moteur - Contrôle du niveau

Le contrôle se fait à froid, à moteur coupé. Si le contrôle a lieu à chaud, il faut que le moteur soit coupé depuis au moins dix minutes.

Ce contrôle s'effectue en mettant la moto sur un plan horizontal et en position de marche (position verticale).

 **ATTENTION: Cette opération doit être effectuée par deux personnes.**

Dévisser le bouchon de remplissage d'huile et le retirer de son logement. Essuyer la barre de contrôle avec un chiffon propre et visser à fond le bouchon de remplissage d'huile dans son logement, puis le dévisser afin de vérifier le niveau d'huile moteur.

Le niveau doit être compris entre les repères MAX et MIN inscrits sur la barre de contrôle de niveau d'huile, relié au bouchon.

Dans le cas où le niveau d'huile se trouve en dessous du repère MIN, effectuer un appoint (voir 1.5.1).

 **Danger - Attention: ne pas démarrer si l'huile est sous le repère du MIN.**

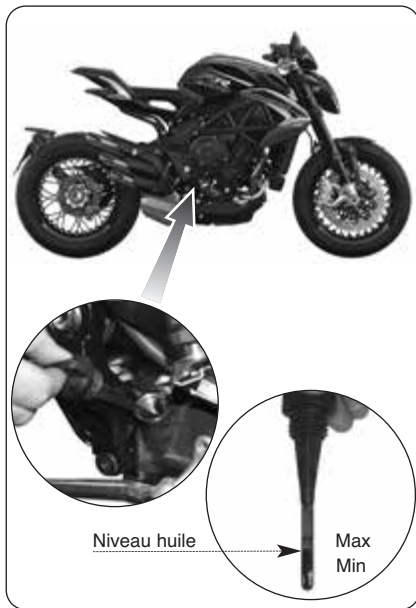



1.5.1. Huile moteur - Appoint

Dévisser le bouchon d'huile. Verser une quantité d'huile du type conseillé jusqu'à arriver à un niveau adéquat: dans tous les cas, ne pas dépasser le repère MAX. Enfin, revisser le bouchon.



RAPPEL

Pour prévenir le patinage de l'embrayage et éviter d'endommager le moteur, ne pas mélanger d'additifs chimiques à l'huile ni utiliser d'huiles autres que celles indiquées au § 1.4. Veiller à ce qu'aucun corps étranger ne pénètre dans le carter pendant le remplissage.



**ATTENTION**

L'huile moteur, neuve ou usagée, peut être dangereuse. L'ingestion d'huile moteur neuve ou usagée peut être nocive pour les personnes et les animaux domestiques. En cas d'ingestion d'huile moteur, appeler immédiatement un médecin et ne pas provoquer le vomissement pour éviter l'aspiration du produit dans les poumons. Il a été constaté que le contact continu avec l'huile moteur provoque le cancer de la peau sur des cobayes. De brefs contacts avec l'huile moteur peuvent irriter la peau.

- Conserver l'huile moteur, neuve ou usée, loin de la portée des enfants et des animaux domestiques.
- Porter des vêtements à manches longues et des gants imperméables à l'eau toutes les fois que l'on effectue un ajout d'huile moteur.
- Se laver à l'eau et au savon si l'huile moteur entre en contact avec la peau.
- Recycler ou évacuer correctement l'huile moteur usagée.



1.6. Liquide de refroidissement - Contrôle du niveau

Le contrôle se fait à froid, à moteur coupé.
Ce contrôle s'effectue en disposant la motocyclette sur un plan horizontal et en position de marche (position verticale).

Le niveau doit être légèrement supérieure à la référence MIN, comme représenté sur la figure.

Dans le cas où le niveau de liquide de refroidissement se trouve sous le repère MIN, ajouter un complément (voir § 1.6.1).



ATTENTION

Ne pas utiliser la moto si le niveau du liquide de refroidissement se trouve en dessous du repère MIN.

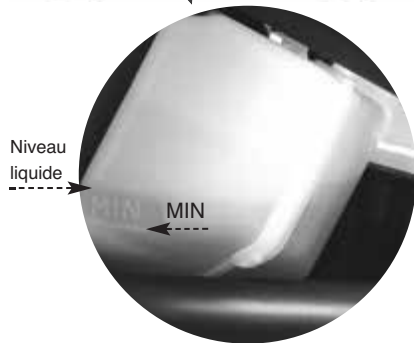



FR 1

1.6.1. Liquide de refroidissement - Appoint

Dévisser et démonter le bouchon du vase d'expansion. Avec une seringue, ajouter le liquide de refroidissement conseillé au § 1.4.



ATTENTION: L'ajout de liquide de refroidissement s'effectue toujours à moteur froid. Ne jamais tenter de retirer le bouchon du réservoir de liquide refroidissement lorsque le moteur est chaud pour éviter les risques de brûlure. Le circuit est sous pression.

Une fois que le niveau est corrigé, remonter soigneusement les parties démontées précédemment.



**ATTENTION**

Dans certaines conditions, le glycol-éthylène contenu dans le liquide de refroidissement est inflammable et sa flamme est invisible. Eviter de mettre le liquide de refroidissement au contact des parties chaudes car la combustion du glycol-éthylène peut exposer à des risques de brûlures.

**ATTENTION**

Le liquide de refroidissement du moteur est nocif en cas d'ingestion ou s'il entre en contact avec les yeux ou la peau. Conserver le liquide de refroidissement loin de la portée des enfants et des animaux domestiques. En cas d'ingestion de liquide de refroidissement, appeler immédiatement un médecin et ne pas provoquer le vomissement pour éviter l'aspiration de produit dans les poumons. En cas de contact du liquide de refroidissement avec les yeux ou la peau, rincer immédiatement à l'eau.

**RAPPEL**

Pour le rétablissement et/ou le vidage du liquide de refroidissement, utiliser exclusivement le produit spécifié au tableau § 1.4. Ne mélangez pas ou ne diluez pas le liquide réfrigérant avec des additifs ou des fluides différents. Au cas où le produit spécifié au tableau § 1.4 ne serait pas possible à trouver, utiliser un liquide réfrigérant avec des caractéristiques techniques conformes au produit prescrit.

**RAPPEL**

Les giclées de liquide de refroidissement peuvent endommager les peintures. Attention à ne pas renverser de liquide lorsque vous remplissez le circuit de refroidissement. Sécher immédiatement avec un chiffon propre le liquide de refroidissement éventuellement renversé.



FR 1

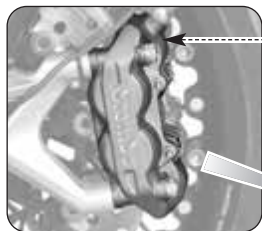

Etrier de frein avant



Etrier de frein arrière

Disque

Plaquettes

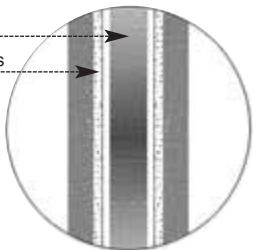

Usure limite 1 mm

1.7. Plaquettes de freins - Contrôle de l'usure

Contrôler périodiquement la largeur de la couche du matériel de frottement des plaquettes, en veillant à ne pas la laisser descendre en dessous de la limite d'usure (1 mm).



Danger – Attention: En cas d'utilisation de la moto avec les plaquettes de frein usées, la puissance de freinage diminue et le risque d'accident augmente. Si l'épaisseur restante est proche de la limite d'usure, s'adresser à un centre d'assistance agréé pour effectuer le remplacement des plaquettes. Soumettre les plaquettes à un rodage.



Réservoir de frein AR.

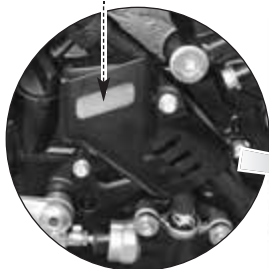

Réservoir de frein AV.

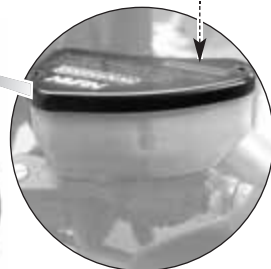
1
FR

1.8. Liquide de freins - Contrôle du niveau



ATTENTION

Les contrôles non effectués et l'entretien négligé des freins augmentent les risques d'accident. Avant toute sortie avec la moto, contrôler le circuit de freinage en suivant les instructions suivantes.

L'usure des plaquettes de freins provoque une baisse de niveau du liquide. Dans tous les cas, le niveau doit être compris entre les repères MAX et MIN. Si ce niveau descend en dessous du repère MIN, il faut s'adresser à un centre de réparation agréé pour un contrôle général du circuit de freinage.

**ATTENTION**

Ne pas utiliser la moto si le niveau se trouve en dessous du repère MIN. Dans ces conditions, le circuit de freinage pourrait ne pas fonctionner correctement avec comme conséquence un risque de perte de contrôle du véhicule et des accidents. Si le niveau de liquide se trouve en dessous du repère MIN, s'adresser à un Concessionnaire MV Agusta pour faire réviser le circuit de freinage.

**ATTENTION**

Faire rectifier le niveau du liquide de frein exclusivement par le personnel autorisé. Le liquide de frein est nocif ou mortel en cas d'ingestion et nocif s'il entre en contact avec les yeux ou la peau. Conserver le liquide de frein loin de la portée des enfants et des animaux domestiques. En cas d'ingestion de liquide de frein, appeler immédiatement un médecin et ne pas provoquer le vomissement pour éviter l'aspiration de produit dans les poumons. En cas de contact du liquide de frein avec les yeux ou la peau, rincer immédiatement à l'eau.

**ATTENTION**

Faire rectifier le niveau de liquide en utilisant uniquement le type de liquide conseillé au §1.4. de ce manuel. Les mélanges éventuels entre fluides de type différents peuvent provoquer une réaction chimique dangereuse et la diminution d'efficacité du freinage avec une augmentation du risque d'accident.

**ATTENTION**

Une quantité insuffisante de liquide de freins peut permettre l'entrée d'air dans le circuit et compromettre ainsi l'efficacité du freinage et augmenter les risques d'accidents. La présence d'air dans le circuit se traduit par une excessive souplesse du levier de frein. En présence d'air dans le circuit, faire purger celui-ci par un concessionnaire MV Agusta avant d'utiliser la moto.



1.9. Liquide d'embrayage - Contrôle du niveau

Le niveau doit être compris entre les repère MAX et MIN. Si ce niveau descend en dessous du repère MIN, il faut s'adresser à un centre de réparation agréé pour un contrôle général du circuit de commande de l'embrayage.



ATTENTION

Ne pas utiliser la moto si le niveau est en dessous du repère MIN. Dans ces conditions le circuit de commande d'embrayage pourrait ne pas fonctionner correctement et créer un risque de perte de contrôle du véhicule et des accidents. Si le niveau de liquide se trouve en dessous du repère MIN, s'adresser à un Concessionnaire MV Agusta pour effectuer l'appoint du fluide de commande d'embrayage.



ATTENTION

Faire rectifier le niveau du liquide de commande d'embrayage en utilisant uniquement le type de fluide conseillé au §1.4. de ce livret.





FR 1 1.10. Pneumatiques - Contrôle et remplacement



ATTENTION

Avant l'utilisation, toujours vérifier la pression des pneumatiques et leur état d'usure.

Le contrôle de la pression des pneumatiques est un facteur fondamental pour assurer la sécurité de conduite. Les pneumatiques insuffisamment gonflés aggravent la maniabilité de la moto et s'usent rapidement. Au contraire, des pneus surgonflés ont une plus petite superficie de contact au sol et peuvent réduire l'adhérence du véhicule.

Avant toute utilisation de la moto, il est donc indispensable de contrôler la pression des pneumatiques à température ambiante, c'est à dire avec la moto à l'arrêt depuis au moins trois heures.



ATTENTION

Un gonflage erroné des pneumatiques entraîne une série de dangers lors de l'utilisation de la moto. Une pression insuffisante peut faire dégonfler le pneu avec pour conséquence un dégonflage et une perte de contrôle du véhicule.



Les résultats obtenus d'un contrôle juste après l'utilisation de la moto donnerait en effet des valeurs plus hautes par rapport à celles réelles et donc un réglage erroné de la pression. Le contrôle de la pression s'effectue en respectant les valeurs données au §3.2. et/ou sur l'étiquette qui se trouve sur le fourreau de la fourche avant droite. En cas de long trajets continus, augmenter la valeur de pression nominale de 0,2 bar.

De plus, avant utilisation, il est extrêmement important de contrôler l'usure des pneumatiques. En effet, des pneus usés ont tendance à subir des crevaisons plus facilement et influent négativement sur la stabilité et la maniabilité de la moto. Au cours du contrôle, s'assurer que l'épaisseur de la bande de roulement ne se trouve pas en dessous des valeurs prescrites par le code de la route et qu'il n'y a pas de fentes sur le fond de l'empreinte. En outre, il ne doit pas y avoir de clous ou de fragments de verre sur le pneumatique, ni de fissures sur son flanc. Dans le cas

contraire, faire remplacer immédiatement le pneumatique chez un Concessionnaire MV Agusta.



ATTENTION

Les limites de profondeur de la bande de roulement du pneu peuvent varier d'un pays à l'autre. Toujours respecter les dispositions légales du pays d'utilisation.



ATTENTION

- **Faire remplacer les pneus excessivement usés par un concessionnaire MV Agusta. L'usage de la moto avec des pneus usés, en plus d'être illégale, réduit la stabilité et peut provoquer la perte de contrôle de la moto.**
- **Si un pneu crève ou subit quelque dommage, il faut le remplacer et non pas le réparer. Un pneu réparé donne des résultats limités et des niveaux de sécurité inférieurs par rapport à un pneu neuf.**



En cas de réparation temporaire ou d'urgence d'un pneumatique, conduire lentement et avec précaution jusqu'au plus proche concessionnaire MV Agusta pour faire remplacer le pneu. Après la réparation d'un pneu, ne pas dépasser la vitesse de 60 km/h. La réparation ne peut pas être effectuée si le pneu est crevé sur le flanc ou si le trou sur la bande de roulement est supérieur à 6 mm.

- Pour la réparation temporaire d'un pneu crevé, MV Agusta déconseille l'utilisation de produits de réparation liquides. Ces produits peuvent influencer négativement sur le matériau formant la stratification des pneus et cacher les dommages secondaires provoqués par d'éventuels objets de pénétration.

- Remplacer les pneus en utilisant exclusivement ceux prescrits au §3.2. Éviter également d'utiliser simultanément des pneus de type ou de marques différentes à l'avant et à l'arrière. L'utilisation de pneus impropres peut influencer négativement sur la maniabilité et la stabilité de la moto, augmentant ainsi les risques d'accidents.

- Les jantes de la moto ont été conçues pour l'utilisation de pneus tubeless. Ne pas monter de pneus avec chambre à air sur les jantes pour pneus tubeless. Les talons pourraient ne pas se mettre en place correctement et les pneus s'affaisser en glissant sur les jantes provoquant une perte de contrôle du véhicule.



- Ne pas monter de chambre à air dans un pneu tubeless. La surchauffe du pneu pourrait faire éclater la chambre à air et provoquer l'affaissement du pneu et la perte de contrôle du véhicule.
- Faire monter les pneus conformément au sens de rotation indiqué par les flèches sur leurs flancs.

- Les pneus neufs doivent être soumis à une période de rodage avant d'être parfaitement efficaces. Durant cette période, il est possible que les pneus aient une adhérence limitée sur certaines surfaces. Nous conseillons donc de conduire à vitesse modérée et de prendre un maximum de précautions pendant au moins 100 km après le montage d'un pneu neuf.



❑ Démontage de la roue arrière



Rappel - Précautions: Au cas où il serait nécessaire de faire remplacer le pneumatique arrière dans un centre spécialisé. Veiller à ce que les outils suivants soient utilisés pour le démontage et le remontage de la roue:

- Clé à douille polygonale de 55 mm
- Clé dynamométrique

Si les opérations sont exécutées avec d'autres outils, les composants de la roue arrière pourraient se retrouver gravement endommagés. Nous conseillons donc de ne pas faire remplacer les pneus par un atelier qui ne possède pas les équipements adéquats. Dans tous les cas, il est préférable de s'adresser à un Concessionnaire MV Agusta.

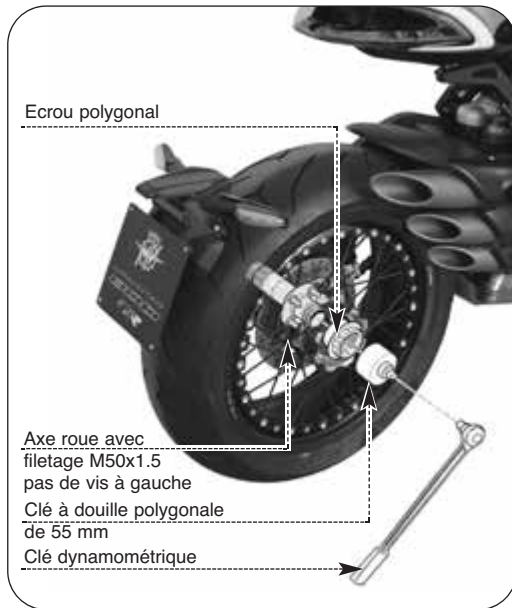



❑ Contrôle des roues

Avant d'utiliser la moto, toujours contrôler que la jante ne présente pas de criques, torsions ou voiles.



ATTENTION

En présence de détériorations, faire remplacer la roue par un concessionnaire MV Agusta. Ne pas tenter d'effectuer de réparations des roues même si ce sont des réparations minimales.

En cas de remplacement du pneumatique ou de la roue, il faut faire effectuer l'équilibrage de la roue chez un concessionnaire MV Agusta. Le déséquilibre de la roue peut compromettre les performances et la maniabilité de la moto et réduire la durée des pneumatiques.



ATTENTION

Pour effectuer l'équilibrage des roues, il faut avoir recours exclusivement à des contrepoids homologués. Il est déconseillé d'utiliser des équilibrants liquides ou des équilibrants liquides/collants.



ATTENTION

Ne pas tenter de faire démonter un pneu tubeless sans l'outillage spécial nécessaire et les protections pour la jante. Dans le cas contraire, on risque d'endommager ou de déformer le bourrelet d'étanchéité de la jante, avec comme conséquence un risque d'affaissement du pneu et une perte de contrôle du véhicule.



1.11. Chaîne - Contrôle et lubrification

Pour effectuer les opérations suivantes, positionner la moto sur la béquille arrière, sur un plan horizontal et avec le sélecteur au point mort.

□ Contrôle du réglage



ATTENTION: Avant de vérifier l'ajustement de la chaîne, s'adresser à un centre d'assistance autorisé MV Agusta pour vérifier que la valeur de l'assiette statique de la suspension arrière est correcte. S'assurer en outre que la chaîne est correctement lubrifiée.

L'axe du brin inférieur de la chaîne doit se trouver à une distance de **116 mm** du pare-chaîne inférieur. Effectuer le contrôle en plusieurs points de la chaîne en tournant manuellement la roue arrière. Le jeu doit rester pratiquement constant pendant que la roue tourne. Si la chaîne présente des fortes variations du jeu, cela signifie que certains maillons sont écrasés, grippés ou allongés. Si la distance entre la chaîne et le pare-chaîne inférieur est supérieure à 116 mm, il faut faire régler la chaîne.

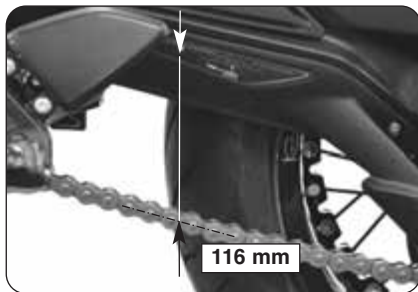

**ATTENTION**

L'utilisation de la motocyclette avec la chaîne en mauvaise état ou mal réglée peut donner lieu à des accidents. Avant chaque utilisation de la moto, effectuer le contrôle de la chaîne en conformité au présent chapitre. Dans le cas où le réglage de la tension de la chaîne s'impose, s'adresser à un centre d'assistance autorisé MV Agusta.

**ATTENTION**

Si la chaîne présente des maillons écrasés, grippés ou allongés, il faut effectuer le remplacement de la chaîne par un centre d'assistance autorisé MV Agusta.

**ATTENTION**

En cas de détérioration ou d'usure excessive de la chaîne et des pignons, il faut s'adresser à un concessionnaire MV Agusta pour le remplacement. Toutes les fois que la chaîne est remplacée, même les pignons doivent être renouvelés.

**ATTENTION**

Il peut être dangereux d'utiliser une chaîne de type à faux maillon. Un maillon principal incomplètement riveté ou de type ouvrant de jonction, peut s'ouvrir et provoquer des accidents ou de sérieux dommages au moteur. Ne pas utiliser de chaînes avec un maillon ouvrant.

**ATTENTION**

Chaque fois qu'est requise d'actionner les vis du moyeu du roue arrière, contactez un concessionnaire autorisé MV Agusta. Afin de serrer les vis, appliquez un couple de serrage égal à la valeur montrée dans l'étiquette placée sur le monobras. L'application d'un couple plus haut que la valeur indiquée peut causer l'affaiblissement rapide du moyeu du roue arrière, compromettant la fiabilité du véhicule et la sûreté du pilote et du passager.



FR 1 Lubrification

La chaîne doit être correctement lubrifiée pour garantir le maximum d'efficacité.

► **Nettoyage préalable:** avant d'effectuer la lubrification, il est nécessaire de dissoudre les dépôts de saleté sur la chaîne en utilisant du mazout. Ces dépôts doivent ensuite être retirés avec un chiffon propre et/ou un jet d'air.



Rappel - Précaution: La chaîne est du type à joints toriques. Pour éviter la détérioration, ne pas effectuer le nettoyage de la chaîne avec des jets de vapeur ou d'eau sous haute pression, ni utiliser d'essence ou de solvants détergents dans le commerce. Le nettoyage de la chaîne s'effectue uniquement avec du mazout.



ATTENTION

Le mazout peut être dangereux. Il est inflammable. Le contact avec le mazout peut être nocif pour les enfants et les animaux domestiques.

Tenir les flammes libres et les objets à haute température loin du mazout. Garder les enfants et les animaux domestiques loin du mazout. Effectuer correctement le traitement du mazout usagé.



► **Lubrification:** appliquer une couche de lubrifiant légère et uniforme sur tout le développement de la chaîne en ayant soin de ne pas toucher les parties environnantes, en particulier les pneumatiques. Diriger le jet du lubrifiant sur les maillons internes, afin de lubrifier la surface des bagues et pénétrer à l'intérieur du rouleau à chaînes.



Rappel - Précaution: Utiliser uniquement le lubrifiant spécifié au tableau § 1.4., afin de protéger la chaîne de transmission et éviter l'huile injecte quand le véhicule est en mouvement.



ATTENTION: La lubrification de la chaîne s'effectue selon les intervalles spécifiés dans le tableau d'entretien Programmé de ce manuel (voir § 1.2). Il est nécessaire d'effectuer cette opération même après la conduite sous la pluie et après chaque lavage de la motocyclette. L'utilisation de la motocyclette avec la chaîne en mauvaises conditions ou non lubrifiée peut donner lieu à des accidents.

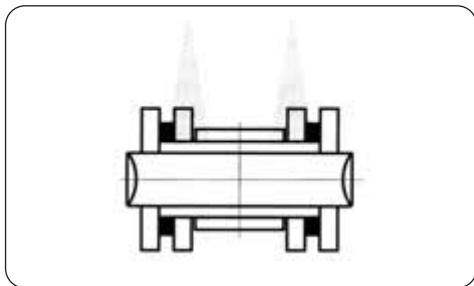

1

FR



FR
1

1.12. Régime du ralenti - Contrôle

Le contrôle s'effectue avec le moteur à température de marche.

Le régime du ralenti doit être compris entre 1250 et 1350 tr/mn.

Pour ce réglage, il faut s'adresser aux centres de réparation agréés.





1.13. Système de contrôle des émissions de vapeur

Les motos **MV Agusta DRAGSTER** sont équipées d'un système antipollution empêchant l'échappement des vapeurs d'essence du réservoir. Afin de maintenir l'efficacité et la fiabilité de ce dispositif, faites réviser votre moto auprès d'un centre d'assistance agréé MV Agusta qui effectuera les opérations suivantes:

Vérifier (et remplacer si nécessaire)

Tuyaux et raccords
Canister

Vérifier (et nettoyer si nécessaire)

Entrée d'air chaud



RAPPEL: Les opérations mentionnées ci-dessus doivent être effectuées selon les intervalles spécifiés dans le tableau d'entretien programmé de ce manuel (voir § 1.2).

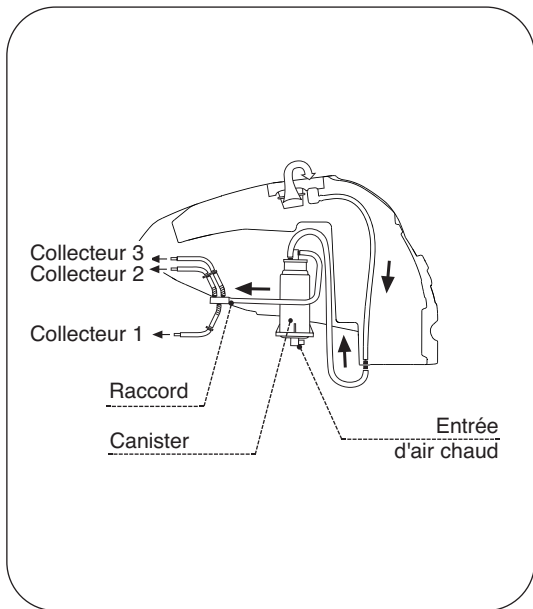



1.14. Remplacements - Informations générales

Le remplacement des fusibles et des ampoules (à l'exception de celles cochées avec ☒ dans le tableau), peut être réalisé par le motard en suivant à la lettre les indications données.

	Fusible de charge batterie - Remplacement (§1.14.1.)
	Fusibles - Remplacement (§1.14.1.)
	Feu de croisement - Remplacement ampoule (§1.14.2.)
	Feu de route - Remplacement ampoule (§1.14.3.)
	Clignotants - Remplacement
	Eclaireur de plaque - Remplacement
	Feu arrière - Remplacement
	Feu de stop - Remplacement

1.14.1. Fusibles - Remplacement

► Le fusible de charge de la batterie se trouve sur le telerupteur de démarreur de la moto, sur le côté droit de la moto.

Pour l'atteindre il faut retirer le couvercle de protection en enlevant les deux vis.

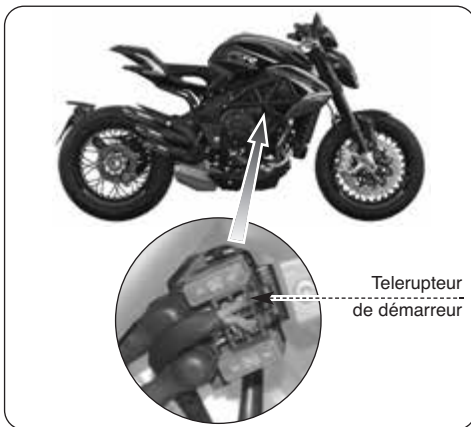



PRÉCAUTION

Tourner la clé de contact sur la position "OFF" avant de contrôler ou de remplacer les fusibles, dans le but d'éviter les courts-circuits accidentels avec risques d'endommager les autres composants électriques.

- Pour remplacer le fusible, il faut inverser la position du fusible de charge avec le fusible de recharge.



ATTENTION

Ne pas utiliser un fusible avec une capacité différente de celle indiquée, dans le but d'éviter la détérioration de l'installation électrique de la motocyclette avec danger d'incendie.

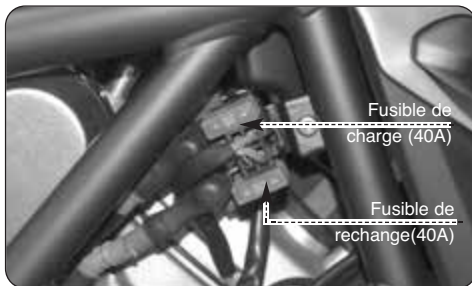

FR
1

► Les fusibles des services se trouvent sur le côté droit de la moto.

► Libérer les deux brides et soulever le couvercle.

**PRÉCAUTION**

Tourner la clé de contact sur la position "OFF" avant de contrôler ou de remplacer les fusibles, dans le but d'éviter les courts-circuits accidentels avec risques d'endommager les autres composants électriques.





► Pour déterminer la position et la fonction du fusible, consulter les informations indiquées sous le couvercle de la boîte des fusibles et sur le schéma électrique fourni; les lettres de références indiquées sur la figure correspondent à celles du schéma.

Il faut se rappeler que dans la boîte porte-fusibles contient quatre fusibles de rechange.

► Remplacer le fusible grillé et remonter le couvercle.



ATTENTION

Ne pas utiliser un fusible avec une capacité différente de celle indiquée, dans le but d'éviter la détérioration de l'installation électrique de la motocyclette avec danger d'incendie.

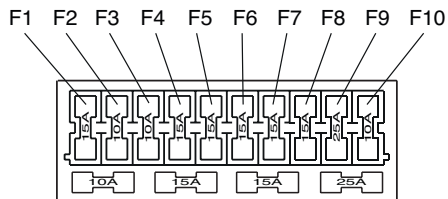

FR
1

1.14.2. Feu de croisement - Remplacement ampoule

► Enlever les quatre vis de fixation du feu avant, deux sur le côté droit et deux sur le côté gauche du véhicule.



► Avant de démonter le feu avant du véhicule, débrancher le connecteur situé dans la partie arrière du feu et les connecteurs des indicateurs de direction avant.





- ▶ Poser le feu sur une table afin d'y effectuer les opérations ci-dessous.
- ▶ Enlever la couvercle arrière.
- ▶ Tourner le connecteur de l'ampoule du feu de croisement dans le sens antihoraire.
- ▶ Extraire l'ampoule.
- ▶ Débrancher les connecteurs de l'ampoule.



Prudence - Précaution: Ne pas toucher le verre de l'ampoule avec les mains. En cas de contact, nettoyer avec un produit dégraissant.

- ▶ Rebrancher les connecteurs sur l'ampoule neuve.
- ▶ Introduire l'ampoule neuve.
- ▶ Tourner le connecteur de l'ampoule dans le sens horaire.
- ▶ Remettre le couvercle arrière en veillant à placer correctement les références de position.
- ▶ Rebrancher le connecteur du feu et les connecteurs des indicateurs de direction avant.
- ▶ Remettre en place le feu sur le véhicule et revisser les quatre vis de fixation, en veillant à placer correctement les câbles dans les sièges latéraux.

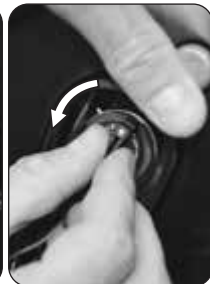

1

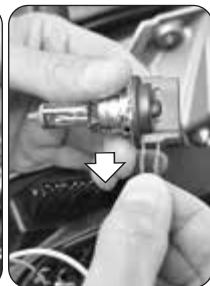
FR



1.14.3. Feu de route - Remplacement ampoule

- ▶ Démontez le feu avant du véhicule comme décrit dans le paragraphe §1.14.2.
- ▶ Décrochez le ressort de fixation de l'ampoule du feu de route.
- ▶ Extraire l'ampoule.
- ▶ Débrancher le connecteur de l'ampoule.



Prudence - Précaution: Ne pas toucher le verre de l'ampoule avec les mains. En cas de contact, nettoyer avec un produit dégraissant.

- ▶ Rebrancher le connecteur sur l'ampoule neuve.
- ▶ Introduire l'ampoule neuve en veillant à placer correctement les références de position.
- ▶ Raccrocher le ressort de fixation.
- ▶ Remonter le feu avant sur le véhicule comme décrit dans le paragraphe §1.14.2.

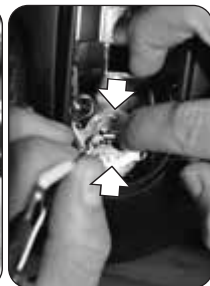



1.15. Batterie

Cette motocyclette est équipée d'une batterie cachetée montée sous le réservoir du carburant. Elle est exempte d'entretien, il n'est donc pas nécessaire de contrôler le niveau de liquide ni d'ajouter de l'eau distillée.

Si la batterie semble déchargée (causant des problèmes électriques ou des démarrages difficiles), la charger le plus tôt possible; pour ce faire connecter le chargeur au connecteur sous le siège du passager. Il faut se rappeler que la batterie a tendance à se décharger plus rapidement si la motocyclette est équipée des accessoires électriques en option.



ATTENTION

Si le corps extérieur de la batterie est endommagé, il peut se produire des écoulements d'acide sulfurique, une substance toxique et hautement corrosive. Éviter tout contact avec la peau, les yeux et les vêtements. Toujours se protéger les yeux lorsqu'on travaille à proximité de la batterie.

En cas de contact, donner les **PREMIERS SECOURS** suivants:

- **CONTACT EXTERNE:** Rincer à l'eau abondante.
- **CONTACT INTERNE:** Boire de grandes quantités d'eau ou de lait et appeler immédiatement un médecin.
- **YEUX:** Rincer à l'eau pendant 15 mn et appeler immédiatement un médecin.

L'écoulement d'acide sulfurique comporte également la formation d'hydrogène qui peut provoquer une explosion en présence d'une étincelle ou d'une flamme. Pour effectuer le remplacement de la batterie, il est nécessaire de s'adresser à un centre d'assistance autorisé MV Agusta.

**FR**
1

Inactivité prolongée

Si la moto est destinée à ne pas être utilisée pendant une période prolongée (un mois ou plus), il est conseillé retirer le fusible de charge (voir §1.14.1). En cas de longue inactivité, il est recommandé de recharger la batterie une fois par mois, afin de garantir sa durée dans le temps.

Pour ce faire, connecter le chargeur au connecteur sous le siège du passager, avec le fusible de charge inséré dans le telerupteur de démarreur.

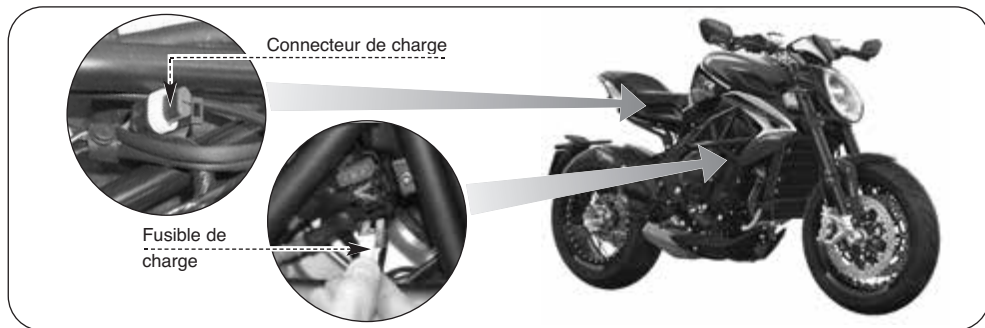



1.16. Nettoyage de la moto

Le nettoyage périodique et méticuleux est important pour préserver la valeur de la moto dans le temps, en protégeant la finition de toutes les surfaces et en contrôlant qu'il n'y a pas d'usure ou de fuites de fluides corrosifs.



Rappel - Précaution: Avant d'effectuer le lavage, obturer les tuyaux d'échappement et protéger les composants électriques.



ATTENTION: Si la moto est encore chaude à cause d'une utilisation récente, attendre que le moteur et le circuit d'échappement aient refroidi.



Rappel - Précaution: ne pas utiliser de machines de lavage à jet d'eau sous haute pression ou à vapeur, car elles peuvent provoquer des infiltrations d'eau et la détérioration des composants de la moto.



NOTE: Les détergents sont polluants pour l'environnement. Le nettoyage du véhicule doit donc être effectué dans des zones équipées pour la récolte et l'épuration des liquides de lavage.



Laver à l'eau, à l'éponge et utiliser un détergent non agressif. Sécher avec un chiffon doux. Dans les zones moins accessibles, utiliser un jet d'air comprimé.



Rappel - Précautions:

- Veiller à ne pas utiliser de chiffons ou d'éponges ayant été en contact avec des produits de nettoyage forts ou abrasifs, des solvants ou de l'essence.
- Pour éviter des dégâts irréversibles au carénage, ne pas utiliser de détergents alcalins ou avec une forte acidité, essence, liquide pour freins ou autres solvants. Nettoyer le carénage uniquement avec un chiffon doux, de l'eau tiède et un détergent neutre.
- Si vous avez des doutes sur la composition chimique du détergent, examinent son effet en l'appliquant sur un secteur du carénage avant de l'employer sur la moto.

Périodiquement, traiter les peintures avec un produit spécial. En cas de trajets sur routes traitées avec des produits corrosifs (sel), effectuer le lava-

ge dès que possible en utilisant de l'eau froide: l'eau chaude favorise l'action corrosive.



ATTENTION: Veiller à ce qu'il n'y ait pas d'huile ou de cire sur les freins ou sur les pneus. Si nécessaire, nettoyer les disques des freins avec un détergent pour disques de frein ou avec de l'acétone et laver les pneus à l'eau chaude et avec un détergent neutre.



ATTENTION: Si les freins sont mouillés, la puissance de freinage peut s'en trouver diminuée. Après le lavage, démarrer le moteur quelques minutes, se mettre en route à vitesse réduite et effectuer quelques freinages avec précaution pour sécher les plaquettes et les disques des freins.









ATTENTION: La chaîne de transmission doit être lubrifiée juste après le lavage et le séchage de la moto selon les instructions données au §1.11. de ce manuel.



1.17. Période d'arrêt prolongé

Si l'on prévoit de laisser la moto à l'arrêt pendant une longue période, il est préférable d'effectuer les opérations ci-dessous.

	Vidanger le réservoir à carburant.
	Retirer le fusible de charge batterie (§1.14.1.). Rechargez la batterie une fois par mois (§1.15.).
	Retirer les capuchons des bougies et les bougies. Verser une cuillère à café d'huile moteur dans chacun des orifices de bougie puis remonter les bougies et leur capuchon et faire tourner le moteur à vide de quelques tours.
	Lubrifier tous les câbles de commande et les axes de rotation de tous les leviers et pédales.
	Nettoyer la moto et traiter les parties peintes avec des produits spéciaux (§1.16.).
	Afin de garantir l'intégrité et la qualité des pneus, garer la moto dans un endroit frais, sec et sombre avec une température relativement constante et inférieure à 25°C. Éviter le contact direct des pneus avec les canalisations ou les radiateurs de chauffage ainsi que le contact prolongé avec huile et essence. Évitez de ranger les pneus à proximité de moteurs électriques ou appareillages en mesure de générer des étincelles ou des décharges électriques. Pendant la période de stationnement, maintenir la moto soulevée sur la béquille arrière.
	Couvrir la moto avec une bâche appropriée

Lors de la première utilisation de la moto, faire un contrôle général et faire effectuer l'entretien (§1.2.) si nécessaire.



2.1. Position du connecteur de diagnostic

Le connecteur pour le logiciel de diagnostic est placé sous la selle du pilote. Pour accéder au connecteur, il faut enlever la selle en suivant les indications du paragraphe §4.6. du Manuel d'Utilisation.

Pour assurer la connexion, il faut connecter le câble d'interface approprié (à commander par le Service des Pièces de Rechange MV Agusta) au connecteur de diagnostic.

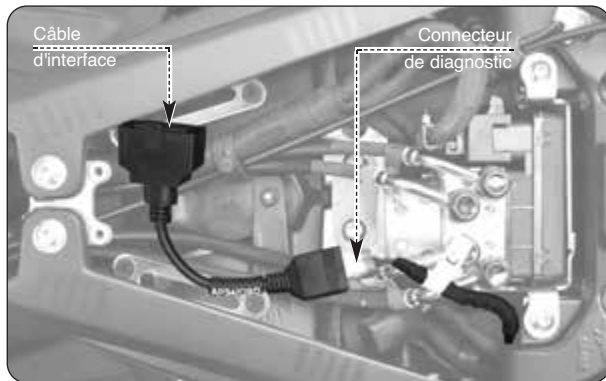

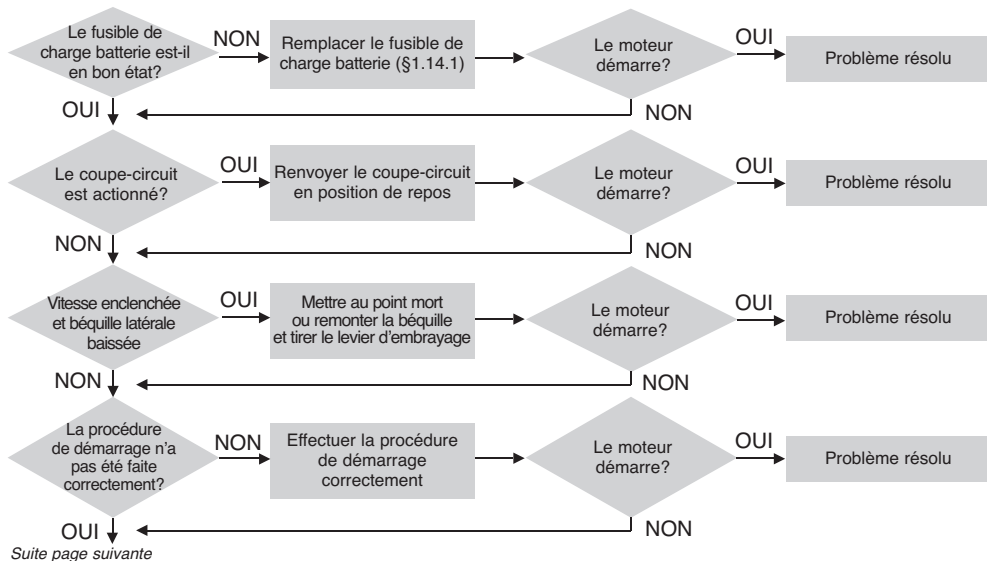
**2.2. Problèmes au moteur: LE MOTEUR NE DÉMARRE PAS**

Suite page suivante



Suite de la page précédente

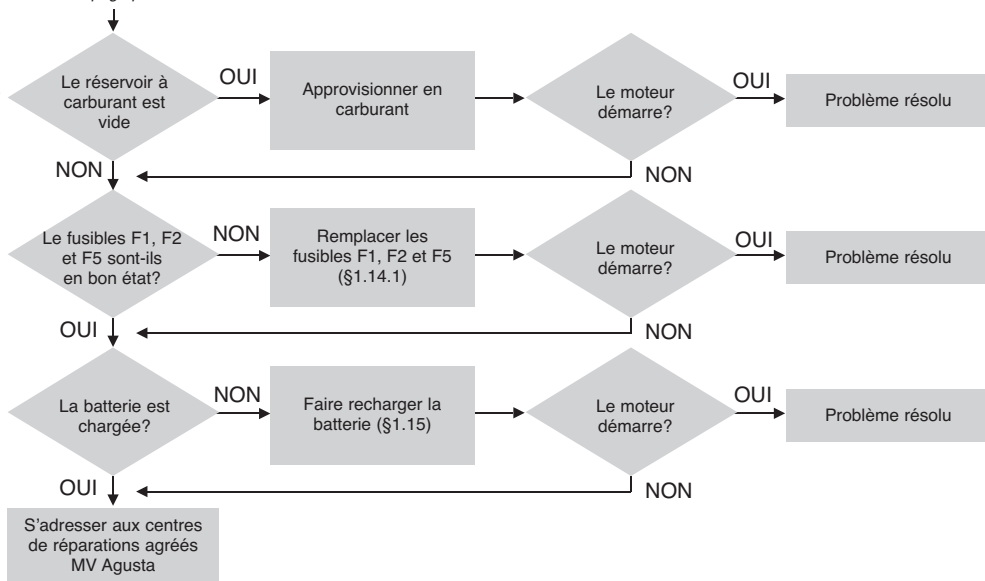



LE MOTEUR A COUPÉ TOUT EN COURANT

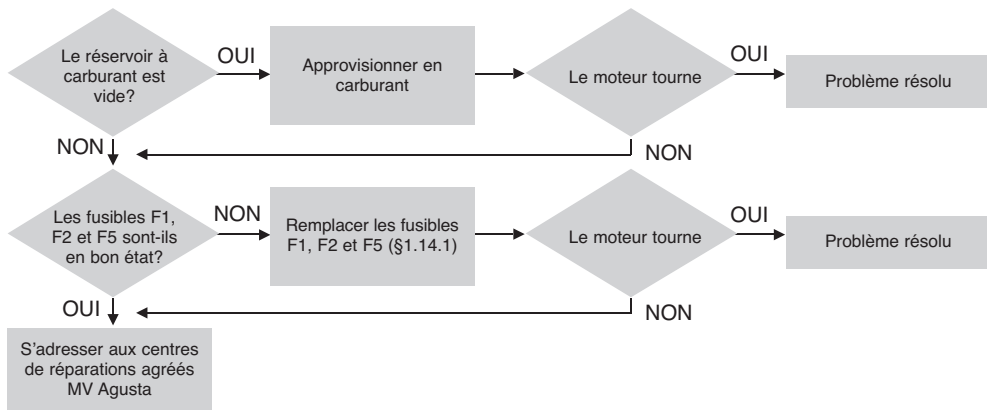



LE MOTEUR SURCHAUFFE

FR 2

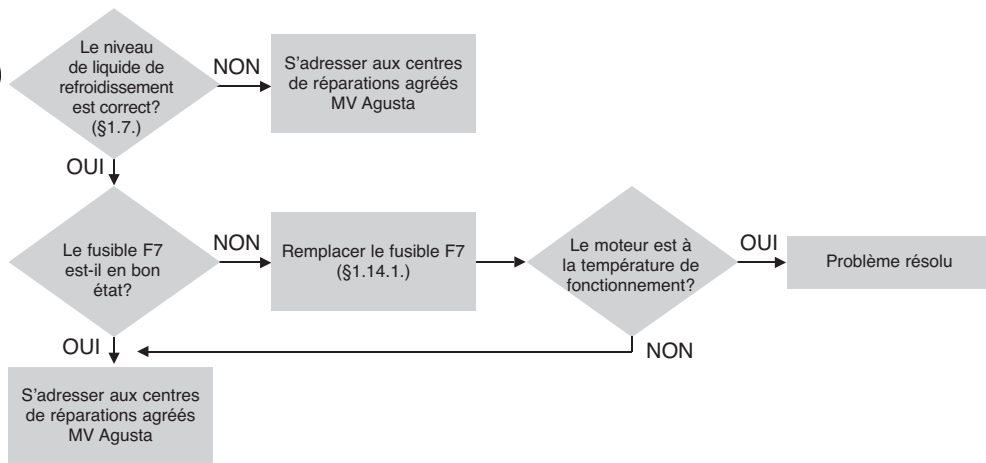

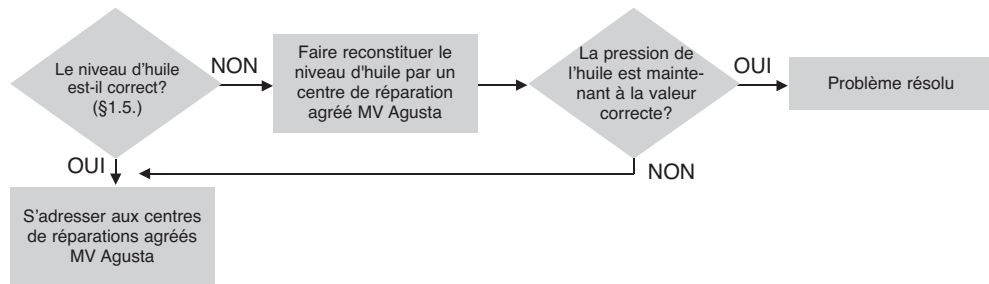
**LA PRESSION D'HUILE EST INSUFFISANTE****(Le voyant de pression d'huile moteur est allumé avec le moteur courant)**



2.3. Problèmes de nature électrique: **LES FEUX NE FONCTIONNENT PAS**

FR 2

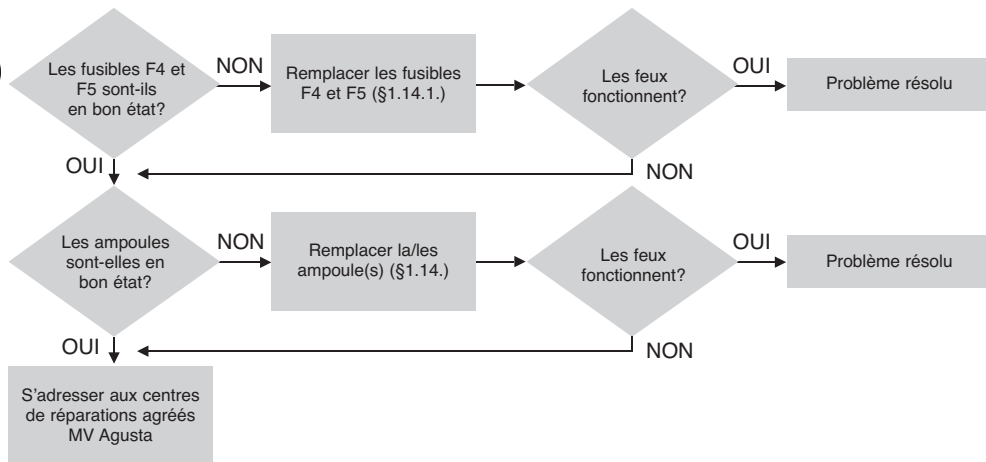



L'AVERTISSEUR SONORE NE FONCTIONNE PAS

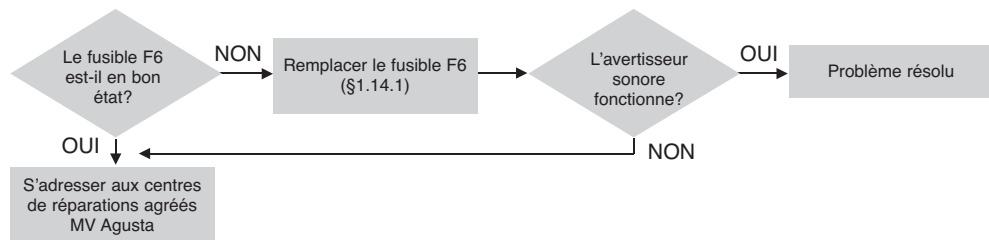

LE TABLEAU DE BORD NE FONCTIONNE PAS

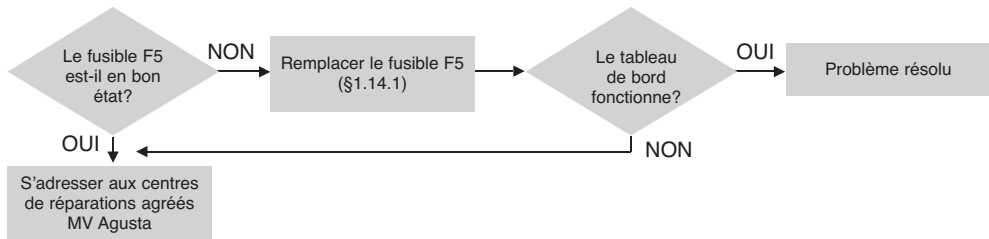



3.1. Description générale de la moto

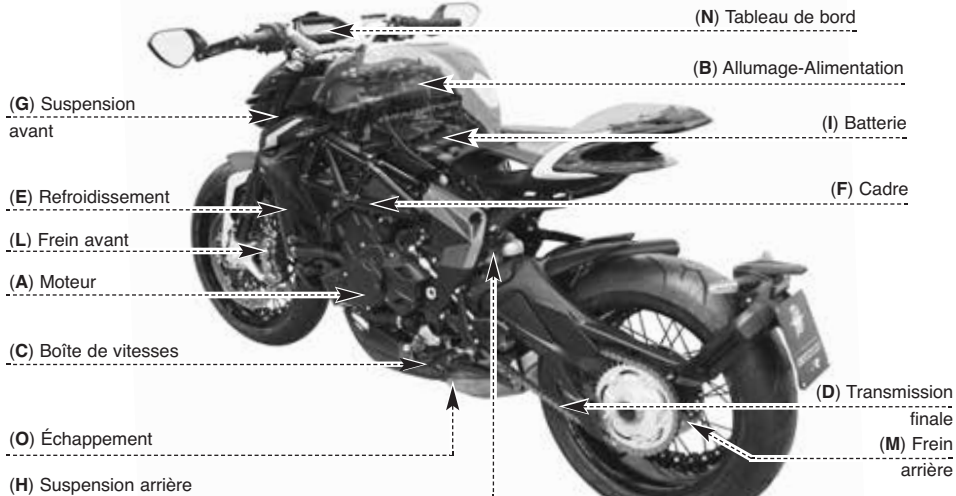



- A - Moteur:** quatre temps, trois cylindres en ligne. Distribution par double arbre à cames en tête. Graissage à carter humide.
- B - Allumage - alimentation:** Système intégré d'allumage - injection. Allumage électronique à décharge inductive. Injection électronique "Multipoint".
- C - Boîte de vitesses:** du type extractible, à six rapports avec pignons en prise constante.
- D - Transmission finale:** composée de pignon, couronne et chaîne.
- E - Refroidissement:** à liquide et huile avec radiateurs séparés.
- F - Cadre:** à treillis, en tube d'acier, avec plaques latérales en aluminium.
- G - Suspension avant:** fourche oléodynamique à tubes inversés, équipée d'un système extérieur de réglage.
- H - Suspension arrière:** à action progressive avec monobras oscillant et monoamortisseur équipée d'un système extérieur de réglage.
- I - Batterie:** scellée et sans entretien.
- L - Frein avant:** double disque semi-flottant avec étriers à quatre pistons.
- M - Frein arrière:** un seul disque avec étrier à deux pistons.
- N - Tableau de bord:** équipé de voyants lumineux et d'appareillage digital.
- O - Échappement:** équipé de convertisseur catalytique pour la réduction des émissions d'échappement.



3.1.1. Système de freinage (ABS)

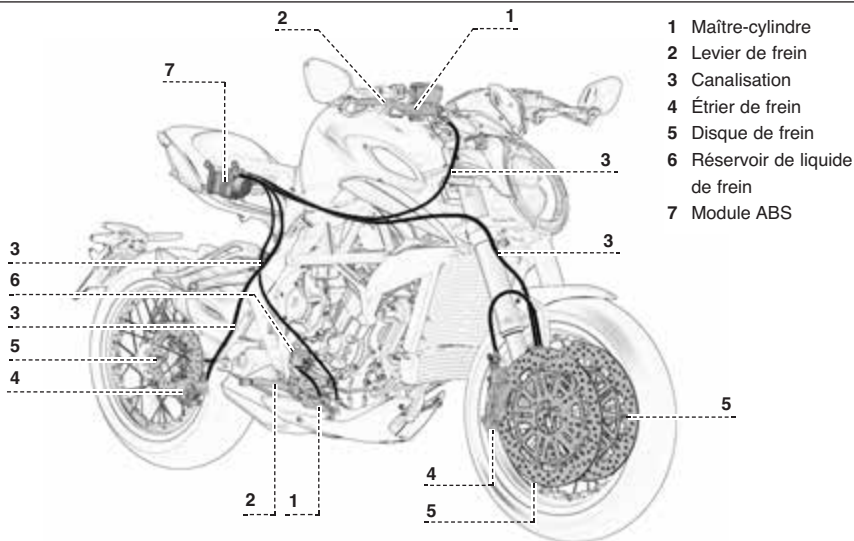



3.1.2. Graissage du moteur

- 1 Carter d'huile
- 2 Filtre à huile

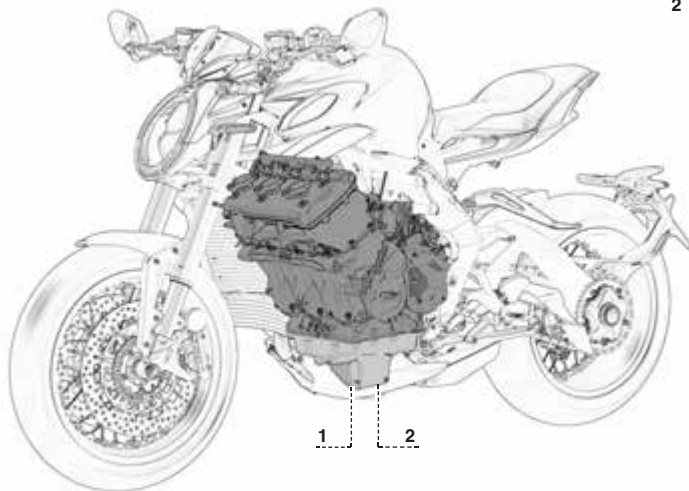



3.1.3. Circuit de refroidissement

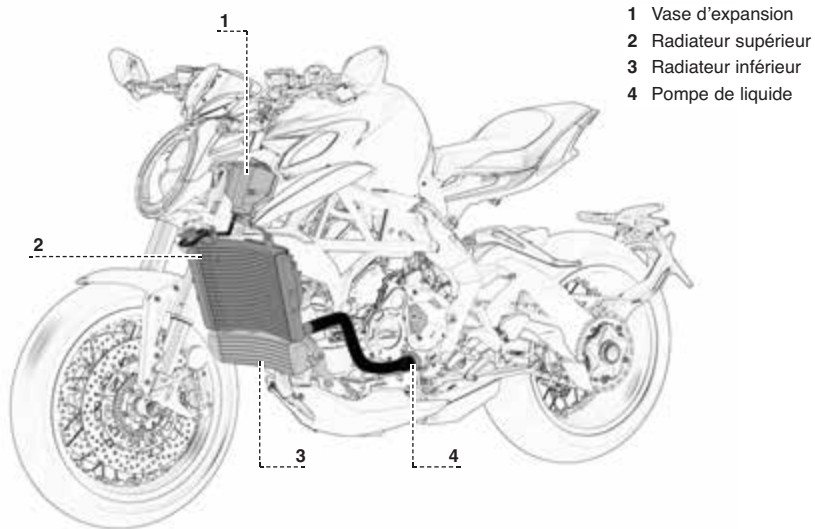



3.1.4. Circuit d'alimentation

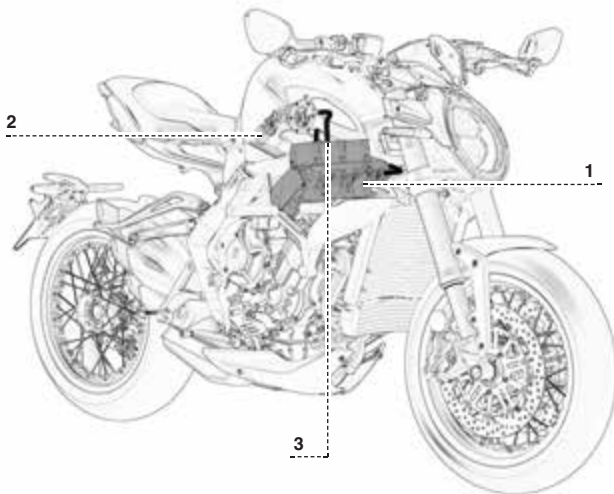

- 1 Corps de papillon
- 2 Pompe à carburant
- 3 Canalisation de carburant



3.2. Données techniques

Description	Dragster 800 Rosso	Dragster RR / RR SCS	Dragster RC / RC SCS
CARACTÉRISTIQUES			
Empattement (mm) (*)	1400	1400	1400
Longueur hors tout (mm) (*)	2035	2035	2035
Largeur hors tout (mm)	935	935	935
Hauteur de selle (mm) (*)	845	845	845
Garde au sol (mm) (*)	135	135	135
Chasse (mm) (*)	103,5	103,5	103,5

* : Les valeurs déclarées sont sans engagement. Elles sont susceptibles de variations en fonction des conditions d'assiette du véhicule.



Données techniques

Description	Dragster 800 Rosso	Dragster RR / RR SCS	Dragster RC / RC SCS
Poids à vide (kg)	168	168	168
Contenance du réservoir carburant (l) (*)	16,5	16,5	16,5
Réserve de carburant (l) (*)	4	4	4
Q.té d'huile dans l'embase (kg)	2,5	2,5	2,5
MOTEUR			
Type	Trois cylindres, 4 temps, 12 soupapes		
Alésage (mm)	79,0	79,0	79,0
Course (mm)	54,3	54,3	54,3
Cylindrée totale (cm ³)	798	798	798
Rapport de compression	12,3 : 1	13,3 : 1	13,3 : 1
Norme environnementale	Euro 4	Euro 4	Euro 4
Émissions de CO ₂ (g/km)	128	163	163
Consommation de carburant (l/100 km)	5,6	6,7	6,7
Démarrreur	Electrique		
Refroidissement	À liquide et huile avec radiateurs séparés		
Carter moteur et couvercles	Moulés sous pression		
Culasse et cylindres	Moulés en coquille		
Soupapes	Acier		

* : Les valeurs déclarées sont sans engagement. Elles sont susceptibles de variations en fonction de la température extérieure, de la température du moteur et du point d'évaporation de l'essence utilisée.



Données techniques

Description	Dragster 800 Rosso	Dragster RR / RR SCS	Dragster RC / RC SCS
DISTRIBUTION			
Type	Double arbre à cames en tête		
GRAISSAGE			
Type	A carter humide		
ALLUMAGE – ALIMENTATION			
Type	Système intégré d'allumage-injection MVICS. Unité de commande moteur Eldor EM2.0; corps de papillon full drive by wire Mikuni; bobines pencil-coil avec technologie "ion-sensing", contrôle de détonation et misfire. Contrôle de couple avec 4 mappages; Traction Control avec 8 niveaux d'intervention.		
Nombre de injecteurs	3	6	6
Bougies	NGK CR9 EIB-9	NGK CR9 EIB-9	NGK CR9 EIB-9
Écartement des électrodes (mm)	0.8 ÷ 0.9	0.8 ÷ 0.9	0.8 ÷ 0.9
EMBRAYAGE			
Type	Multidisque en bain d'huile avec commande hydraulique avec dispositif mécanique d'anti-houblon		
TRANSMISSION PRIMAIRE			
Nombre de dents pignon vilebrequin	Z = 22	Z = 22	Z = 22
Nombre de dents pignon d'embrayage	Z = 41	Z = 41	Z = 41
Rapport de transmission	1,864	1,864	1,864
TRANSMISSION SECONDAIRE			
Nombre de dents du pignon	Z = 16	Z = 16	Z = 16
Nombre de dents de la couronne	Z = 41	Z = 41	Z = 41
Rapport de transmission	2,563	2,563	2,563



Données techniques

Description	Dragster 800 Rosso	Dragster RR / RR SCS	Dragster RC / RC SCS
BOITE DE VITESSES			
Type	Extractible à six vitesses avec pignons en prise constante		
Rapports vitesses (rapports totaux)			
Première	2.846 (13.593)	2.846 (13.593)	2.846 (13.593)
Seconde	2.187 (10.447)	2.125 (10.149)	2.125 (10.149)
Troisième	1.778 (8.635)	1.778 (8.635)	1.778 (8.635)
Quatrième	1.500 (7.165)	1.579 (7.541)	1.579 (7.541)
Cinquième	1.318 (6.295)	1.429 (6.823)	1.429 (6.823)
Sixième	1.190 (5.684)	1.318 (6.295)	1.318 (6.295)
CADRE			
Type	Tube à tresse en acier ALS (soudé en MAG)		
Plaque d'ancrage du bras oscillant	Alliage de aluminium		
SUSPENSION AVANT			
Type	Fourche oléodynamique à tubes inversés avec système de réglage extérieur et séparé du freinage en détente, en compression et de la précharge du ressort		
Ø des tubes (mm)	43	43	43
Débattement (mm)	125	125	125
SUSPENSION ARRIÈRE			
Type	Progressive, monoamortisseur réglable en détente, en compression et en précharge du ressort		
Bras oscillant	Alliage de aluminium		
Débattement (mm)	124	124	124



Données techniques

Description	Dragster 800 Rosso	Dragster RR / RR SCS	Dragster RC / RC SCS
FREIN AVANT			
Type	A double disque flottant avec bande freinante en acier		
Ø disque (mm)	320		
Plateau de frein	Acier		
Étriers (diamètre des pistons mm)	Radiaux a 4 pistons (Ø 32)		
FREIN ARRIÈRE			
Type	À disque en acier		
Ø disque (mm)	220		
Étrier (diamètre des pistons mm)	À 2 pistons (Ø 34)		
JANTE AVANT			
Matériau	Alliage d'aluminium	Roue à rayons - Alliage d'aluminium	Forgée en alliage d'aluminium
Dimension	3.50" x 17"	3.50" x 17"	3.50" x 17"
JANTE ARRIÈRE			
Matériau	Alliage d'aluminium	Roue à rayons - Alliage d'aluminium	Forgée en alliage d'aluminium
Dimension	6.00" x 17"	6.00" x 17"	6.00" x 17"
PNEUMATIQUES			
Avant	120/70 ZR 17 M/C (58 W)	120/70 ZR 17 M/C (58 W)	120/70 ZR 17 M/C (58 W)
Arrière	200/50 ZR 17 M/C (75 W)	200/50 ZR 17 M/C (75 W)	200/50 ZR 17 M/C (75 W)



Données techniques

Description	Dragster 800 Rosso	Dragster RR / RR SCS	Dragster RC / RC SCS
Marque et type	PIRELLI Diablo Rosso II	PIRELLI Diablo Rosso II	PIRELLI Diablo Rosso II
Pression de gonflage (*):			
Avant	2.5 bar (36 psi)	2.5 bar (36 psi)	2.5 bar (36 psi)
Arrière	2.8 bar (41 psi)	2.8 bar (41 psi)	2.8 bar (41 psi)
ÉQUIPEMENT ÉLECTRIQUE			
Tensione impianto Tension du circuit	12 V		
Feu de croisement avant	H11B 12V 55W		
Feu de croisement arrière	H3 12V 55W		
Feux clignotants	LED		
Feu de position arrière	LED		
Feu de stop	LED		
Batterie	12 V - 8,6Ah		
Alternateur	350 W à 5000 tr/mn.		
CARROSSERIE			
Réservoir	Matière thermoplastique		
Flancs réservoir	Matière thermoplastique	Matière thermoplastique	Fibre de carbone
Flancs arrière	Matière thermoplastique		

* : Dans le cas de pneus d'une autre marque que celle préconisée, se référer à la valeur de pression de gonflage marquée par le constructeur sur le flanc du pneumatique.

**Données techniques**

Description	Dragster 800 Rosso	Dragster RR / RR SCS	Dragster RC / RC SCS
Couvercle instruments	Matière thermoplastique	Matière thermoplastique	Fibre de carbone
Garde-boue arrière	Matière thermoplastique	Matière thermoplastique	Fibre de carbone
Garde-boue avant	Matière thermoplastique		
Supports du garde-boue avant	Matière thermoplastique	Matière thermoplastique	Fibre de carbone
Flancs airbox	Matière thermoplastique		
Protection chaîne	Matière thermoplastique		
Support de plaque d'immatriculation	Matière thermoplastique		
Rétroviseurs	Matière thermoplastique		
Protection tuyau d'échappement	Aluminium		
Protections latérales des radiateurs	Matière thermoplastique		





FR 3





3.3. Référence couleurs des superstructures (Dragster 800 Rosso)

Les parties peintes des superstructures présentent les couleurs suivantes:

1. - Réservoir de carburant:

Rouge F4 Ago
(Réf. Palinal 926R750)

- 2. - Flanc central droit;
- 3. - Flanc central gauche:
- 4. - Flanc avant droit;
- 5. - Flanc avant gauche;
- 6. - Flanc arrière droit;
- 7. - Flanc arrière gauche:

Noir Carbon Métallisé
(Réf. Palinal 928.V311)



FR 3





3.4. Référence couleurs des superstructures (Dragster RR / RR SCS MY20)

Les parties peintes des superstructures présentent les couleurs suivantes en fonction du code couleur respectif de la moto:

1. - Réservoir de carburant:

- Code couleur A:

Gris Nuit

(Réf. Lechler LCH29902-662) +

Noir Carbon Métallisé

(Réf. Palinal 928.V311)

- Code couleur B:

Blanc ICE Nacrée

(Réf. Lechler 2902181) +

Noir Carbon Métallisé

(Réf. Palinal 928.V311)

2. - Flanc central droit;

3. - Flanc central gauche:

Noir Carbon Métallisé

(Réf. Palinal 928.V311)

4. - Flanc avant droit;

5. - Flanc avant gauche;

6. - Flanc arrière droit;

7. - Flanc arrière gauche:

- Code couleur A:

Jaune Nacrée Métallisé

(Réf. Lechler LCC00997 +

Lechler LCC00998)

- Code couleur B:

Vert Néon

(Réf. Lechler BDCR216)



FR 3





3.5. Référence couleurs des superstructures (Dragster RC / RC SCS MY20)

Les parties peintes des superstructures présentent les couleurs suivantes:

1. - Réservoir de carburant;
2. - Flanc avant droit;
3. - Flanc avant gauche:

Gris Avio Métallisé
(Réf. Palinal 928.T892) +
Noir Carbon Métallisé
(Réf. Palinal 928.V311)

4. - Garde-boue avant;
5. - Flanc airbox droit;
6. - Flanc airbox gauche;
7. - Flanc arrière droit;
8. - Flanc arrière gauche:

Gris Avio Métallisé
(Réf. Palinal 928.T892)



FR 3

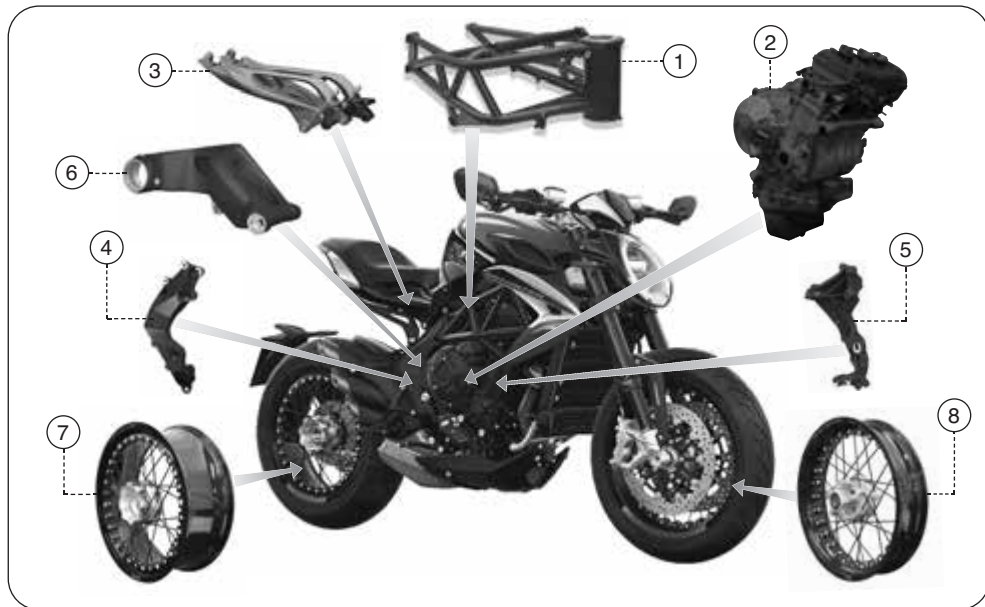



3.6. Référence couleurs composants du châssis et de la partie cycle

Les parties peintes du cadre de la moto présentent les couleurs de référence suivantes:

1. - Cadre:

- **Dragster 800 / RR / RR SCS MY20:**
Noir Brillant (Réf. PPG PCU 90207)
- **Dragster RC / RC SCS MY20:** Rouge
Cadre (Réf. Akzo Nobel QG000K Red)

3. - Cadre arrière;

4. - Plaque de châssis droite;

5. - Plaque de châssis gauche;

6. - Bras oscillant:

Noir Quasar

(Réf. Inver 61196 - Poliést/HD TGIC Free)

2. - Moteur:

Noir Mat

(Réf. Pulverit 3500/0085)

7. - Jante de la roue arrière;

8. - Jante de la roue avant:

- **Dragster 800 Rosso:** Noir Brillant
(Réf. Peter Lacke VPCH03250)
- **Dragster RR / RR SCS MY20:**
Noir Brillant
- **Dragster RC / RC SCS MY20:**
Rouge Brillant (Réf. Da Qiao
WFMY-S09-Q + WFMY-S10-Q)



Note d'information

MV Agusta Motor S.p.A. poursuit une politique de continuelle amélioration de ses produits. Pour cette raison, de légères différences pourraient éventuellement se présenter entre les informations de ce livret et le véhicule que vous avez acheté. Les modèles MV Agusta s'exportent dans de nombreux pays où des normes différentes sont en vigueur en ce qui concerne le Code de la Route et les procédures d'homologation. En espérant pouvoir compter sur votre compréhension, il est indispensable à MV Agusta Motor S.p.A. de se réserver le droit d'apporter des modifications à ses produits et à la documentation technique à tout moment sans fournir de préavis.

Nous suggérons de visiter souvent le site Internet www.mvagusta.com afin d'obtenir des informations et des mises à jour sur les produits MV Agusta et la documentation relative.



Respectons et défendons l'environnement

Toutes nos actions ont des répercussions sur la planète entière et sur ses ressources. MV Agusta, au profit des intérêts de tous, sensibilise les Clients et les opérateurs du service après-vente pour leur faire adopter des modalités d'utilisation du véhicule et de traitement de ses parties dans le respect des normes en vigueur en terme de pollution, traitement et recyclage des déchets.

© 2020

Toute reproduction même partielle de ce document est formellement interdite sans autorisation écrite de MV Agusta Motor S.p.A.

Dét. n° 8000C8714

Edition n° 1 - Janvier 2020

MV AGUSTA

**DRAGSTER
EIGHTHOUR**



Wartungsanleitung
Deutsche Version



ALLGEMEINES INHALTSVERZEICHNIS

<i>Kap.</i>	<i>Inhalt</i>	<i>Seite</i>
1	WARTUNG	3
1.1.	Zeichenerklärung	3
1.2.	Tabelle Wartungs- und Kontrollarbeiten	4
1.3.	Mitgeliefertes Bordwerkzeug und Zubehör	14
1.4.	Schmiermitteltabelle	15
1.5.	Motoröl - Ölstandkontrolle	16
1.5.1.	Nachfüllen von Motoröl	17
1.6.	Kühflüssigkeit - Kontrolle Kühflüssigkeitsstand	19
1.6.1.	Kühflüssigkeit - Nachfüllen von Kühflüssigkeit	20
1.7.	Bremsbeläge - Kontrolle Abnutzung/ Verschleiß	22
1.8.	Bremsflüssigkeit - Kontrolle Bremsflüssigkeitsstand	23
1.9.	Flüssigkeit Kupplungsbetätigung - Kontrolle Flüssigkeitsstand	25
1.10.	Reifen - Kontrolle und Wechsel	26
1.11.	Kette - Kontrolle und Schmieren	32
1.12.	Leerlaufdrehzahl - Kontrolle	36
1.13.	Steuersystem der Verdampfungsemissions	37
1.14.	Auswechseln - Allgemeine Informationen	38
1.14.1.	Sicherungen - Auswechseln	38
1.14.2.	Fahrlicht - Auswechseln der Birne	42

<i>Kap.</i>	<i>Inhalt</i>	<i>Seite</i>
1.14.3.	Fernlicht - Auswechseln der Birne	44
1.15.	Batterie	45
1.16.	Fahrzeuopflege	47
1.17.	Längeres Stilllegen	49
2	STÖRUNGEN	50
2.1.	Position des Diagnosestecker	50
2.2.	Störungen am Motor	51
2.2.	Störungen an der elektrischen Anlage	56
3	TECHNISCHE INFORMATIONEN	58
3.1.	Allgemeine Beschreibung des Motorrads	58
3.1.1.	Bremssystem (ABS)	60
3.1.2.	Motorschmierung	61
3.1.3.	Kühlkreislauf	62
3.1.4.	Benzin-Versorgungskreislauf	63
3.2.	Technische Daten	64
3.3.	Überbau - Farbkennziffern (Dragster 800 Rosso)	72
3.4.	Überbau - Farbkennziffern (Dragster RR / RR SCS MY20)	74
3.5.	Überbau - Farbkennziffern (Dragster RC / RC SCS MY20)	76
3.6.	Rahmen- und Radfahrteile Farbkennziffern	78



1.1. Zeichenerklärung

Besonders wichtige Textstellen die sich auf die Sicherheit der Personen oder des Fahrzeugs beziehen, sind mit folgenden Symbolen gekennzeichnet:



Gefahr - Achtung: Die mangelnde oder unvollständige Beachtung dieser Vorschriften stellt eine schwere Unfallgefahr für den Arbeiter oder Dritte dar.



Vorsicht - Vorsichtsmaßnahme: Die Nichteinhaltung der Anweisungen kann schwere und dauerhafte Schäden am Fahrzeug verursachen.

Folgende Symbole werden benutzt, um anzuzeigen, wer die angegebenen Wartungs- und Einstellungsarbeiten ausführen darf:



Informationen zu Arbeiten, die vom Motorradfahrer ausgeführt werden dürfen.



Informationen zu arbeiten, die ausschließlich von ausgebildetem Fachpersonal ausgeführt werden dürfen.

Um weitere Informationen hervorzuheben, werden folgende Symbole verwendet:



Das Symbol zeigt an, dass für die richtige Durchführung der angegebenen Arbeit ein Spezialwerkzeug oder Sonderausrüstung benötigt werden.



Das Zeichen “§” gefolgt von einer Ziffer verweist auf das entsprechende Kapitel.



1.2. Tabelle Wartungs- und Kontrollarbeiten

Die wichtigsten Wartungs- und Kontrollarbeiten sowie deren zeitlicher Abstand sind in den entsprechenden Tabellen aufgeführt. Um das Motorrad funktionsfähig und sicher zu halten, müssen die angegebenen unbedingt Arbeiten ausgeführt werden.

Die angegebenen Zeitabstände für die Wartungsarbeiten haben allgemeinen Charakter und gelten für einen Einsatz des Fahrzeugs unter normalen Bedingungen. Abhängig von Wetterbedingungen, Straßenzustand, geografischen Voraussetzungen und persönlichem Einsatz des Fahrzeugs müssen die angegebenen Zeitabstände unter Umständen verkürzt werden.

Einige dieser Arbeiten können vom Fahrzeughalter selbst ausgeführt werden, sofern er über die entsprechenden Fähigkeiten und Kenntnisse verfügt. Andernfalls müssen diese Arbeiten vom Kundendienst vorgenommen werden.

Für die Wartungsarbeiten muß das Motorrad auf den hinteren Ständer gestellt, der Motor abgeschaltet und der Zündschlüssel auf "OFF" gestellt werden. Zur Kontrolle der Flüssigkeitsstände sollte das Fahrzeug ohne auf den hinteren Ständer zu stellen senkrecht gehalten werden.

Nach 105.000 km (63.000 mile) müssen die Arbeiten in den gleichen Abständen wie in der Tabelle angegeben ausgeführt werden.



ACHTUNG

- Eine falsche Wartung oder die Nichtausführung der empfohlenen Wartungsarbeiten erhöht das Unfallrisiko und die Gefahr einer Beschädigung des Motorrads.
- Ausschließlich Original MV Agusta Ersatzteile verwenden. Der Einsatz nicht originaler Ersatzteile kann zu vorzeitigem Verschleiß führen und verkürzt die Lebenszeit des Motorrads.
- Bei Nichtausführung der empfohlenen Wartungsarbeiten aus dem Wartungsprogramm oder bei Verwendung nicht originaler Ersatzteile konnte die Garantie veranlassen, unzulässig zu sein.
- Der Wechsel bzw. das Auffüllen von Schmiermitteln oder anderen Flüssigkeiten darf nur mit den in § 1.4. angegebenen Produkten erfolgen.



ACHTUNG

Vor und nach dem Befahren einer Rennstrecke sollten Sie Ihr Motorrad unbedingt von einem Fachmann in einer MV Agusta-Vertragswerkstatt überprüfen lassen. Das Fahren auf Rennstrecken sollte jedoch eine Ausnahme darstellen und niemals im Rahmen eines Profi- oder Amateur-Wettkampfes stattfinden. Der Einsatz auf einer Rennstrecke bedeutet für das Motorrad eine wesentlich stärkere Abnutzung der diversen Komponenten und verkürzt demnach auch deren Lebensdauer im Vergleich zur normalen Benutzung auf Straßen und Autobahnen.



DE 1

Tabelle programmierte Wartungsarbeiten

(*): Die Laufleistung-Coupons können zusammen mit der **obligatorischen** jährlichen Kupon durchgeführt werden

Häufigkeit der Wartungsarbeiten Km (mi)*		0	1000 (600)	Jedes Jahr	15000 (9000)	30000 (18000)	45000 (27000)	60000 (36000)	75000 (45000)	90000 (54000)	105000 (63000)
Coupon		Auslieferung	A	B	C	D	E	F	G	H	
BESCHREIBUNG	ARBEIT										
Motorsteuergerät	Kontrolle Mapping		•	•	•	•	•	•	•	•	•
Motoröl	Kontrolle / Auffüllen		Vor jedem Fahrtantritt								
	Kontrolle / Auffüllen	•									
	Ölwechsel		•	•	•	•	•	•	•	•	•
Motorölfilter	Wechsel (Ausschließlich Original MV Agusta Motorölfilter verwenden)		Bei jedem Ölwechsel								
Kühlflüssigkeit	Kontrolle / Auffüllen		Vor jedem Fahrtantritt								
	Kontrolle / Auffüllen	•	•	•	•	•	•	•	•	•	•
	Wechsel		Alle zwei Jahre								
Kühlanlage	Kontrolle Lecks	•	•	•	•	•	•	•	•	•	•
Gebälse	Funktionskontrolle	•	•	•	•	•	•	•	•	•	•
Ventile	Kontrolle/Einstellung					•		•		•	
Kette Ventilsteuerung	Austausch										•



Tabelle programmierte Wartungsarbeiten

(*): Die Laufleistung-Coupons können zusammen mit der **obligatorischen** jährlichen Kupon durchgeführt werden

Häufigkeit der Wartungsarbeiten Km (mi)*		0	1000 (600)	Jedes Jahr	15000 (9000)	30000 (18000)	45000 (27000)	60000 (36000)	75000 (45000)	90000 (54000)	105000 (63000)
Coupon		Auslieferung	A	B	C	D	E	F	G	H	
BESCHREIBUNG	ARBEIT										
Feste Führung der Ventilsteuerkette	Austausch										•
Bewegliche Führung der Ventilsteuerkette	Austausch										•
Kettenspanner Ventilsteuerung	Austausch										•
Zündkerzen	Austausch					•		•		•	
Benzinfilter	Austausch					•		•		•	
Drosselklappengehäuse	Kontrolle / Reinigung der Kanäle					•		•		•	
	Kontrolle Drucksensor					•		•		•	
Luftfilter (Reduzieren Sie die Intervalle wenn Sie in hoch belasteten Gebieten fahren)	Kontrolle / Austausch				•		•		•		•
	Austausch					•		•		•	
Zylinder	Kontrolle der Kompression					•		•		•	
Brems- und Kupplungsflüssigkeit	Kontrolle Flüssigkeitsstand	Vor jedem Fahrtantritt									
	Kontrolle Flüssigkeitsstand	•	•	•	•	•	•	•	•	•	•
	Wechsel	Mindestens alle zwei Jahre									



Tabelle programmierte Wartungsarbeiten

(*): Die Laufleistung-Coupons können zusammen mit der **obligatorischen** jährlichen Kupon durchgeführt werden

Häufigkeit der Wartungsarbeiten Km (mi)*		0	1000 (600)	Jedes Jahr	15000 (9000)	30000 (18000)	45000 (27000)	60000 (36000)	75000 (45000)	90000 (54000)	105000 (63000)
Coupon		Auslieferung	A	B	C	D	E	F	G	H	
BESCHREIBUNG	ARBEIT										
Bremsen / Kupplung	Funktionskontrolle	Vor jedem Fahrtantritt									
	Kontrolle Funktions- und Bremskreislauf	•	•	•	•	•	•	•	•	•	•
	Reinigung Kontaktbereich zw. Hebel/Hauptzylinderkolben		•	•	•	•	•	•	•	•	•
Kupplung-Reißschutz	Kontrolle / Austausch										•
Bremsbeläge (vorne und hinten)	Abnutzungskontrolle	Alle 1.000 km (600 mile)									
	Kontrolle / Austausch	•		•	•	•	•	•	•	•	•
Benzinleitungen	Fehler und Verlustkontrolle		•	•	•	•	•	•	•	•	•
	Austausch	Alle 3 Jahre									
Gasgriff	Funktionskontrolle	Vor jedem Fahrtantritt									
	Funktionskontrolle (mit Diagnose-Software TEXA)	•	•	•	•	•	•	•	•	•	•
Zahnkranz-Reißschutz	Kontrolle			•							
	Kontrolle/Anziehen der Mutter		•	•							
	Austausch				•	•	•	•	•	•	•



Tabelle programmierte Wartungsarbeiten

(*): Die Laufleistung-Coupons können zusammen mit der **obligatorischen** jährlichen Kupon durchgeführt werden













Häufigkeit der Wartungsarbeiten Km (mi)*		0	1000 (600)	Jedes Jahr	15000 (9000)	30000 (18000)	45000 (27000)	60000 (36000)	75000 (45000)	90000 (54000)	105000 (63000)
Coupon		Auslieferung	A	B	C	D	E	F	G	H	
BESCHREIBUNG	ARBEIT										
Antriebskette 	 Kontrolle	Alle 1.000 km (600 mile)									
	 Schmierem	Alle 1.000 km (600 mile) und nach Fahrten bei Regen									
	 Kontrolle / Einstellung	•	•	•	Mindestens alle 1.000 km (600 mile)						
	 Schmierem	Mindestens alle 1.000 km (600 mile)									
Ritzel / Sprengling	 Austausch				•	•	•	•	•	•	•
	 Kontrolle		•	•							
Zahnkranz	 Austausch				•	•	•	•	•	•	•
	 Kontrolle		•	•							
Reifen	 Kontrolle Reifendruck	Vor Fahrtantritt, mindestens alle 10 Tage									
	 Kontrolle Abnutzung	Vor Fahrtantritt, mindestens alle 500 km (300 mi)									
	 Kontrolle Reifendruck	•	•	•	•	•	•	•	•	•	•
	 Kontrolle Abnutzung		•	•	•	•	•	•	•	•	•



Tabelle programmierte Wartungsarbeiten

(*): Die Laufleistung-Coupons können zusammen mit der **obligatorischen** jährlichen Kupon durchgeführt werden



















Häufigkeit der Wartungsarbeiten Km (mi)*		0	1000 (600)	Jedes Jahr (9000)	15000 (9000)	30000 (18000)	45000 (27000)	60000 (36000)	75000 (45000)	90000 (54000)	105000 (63000)
Coupon		Auslieferung	A	B	C	D	E	F	G	H	
BESCHREIBUNG	ARBEIT										
Lenklager 	 Kontrolle / Einstellung		•		•		•		•		•
	 Schmierem					•		•		•	
Radfelgen 	 Sichtkontrolle	•	•	•	•	•	•	•	•	•	•
		Bei jedem Reifenwechsel									
Speichen des Rades (Dragster RR-SCS) 	 Kontrolle / Festziehen		•	•	•	•	•	•	•	•	•
		Mindestens einmal jährlich									
Vorderradlager 	 Kontrolle				•	•	•		•	•	•
		Bei jedem Reifenwechsel									
	 Austausch							•			
Seitenständer 	 Funktionskontrolle	Vor jedem Fahrtantritt									
	 Funktionskontrolle	•	•	•	•	•	•	•	•	•	•
Seitenständerschalter 	 Funktionskontrolle	Vor jedem Fahrtantritt									
	 Funktionskontrolle	•	•	•	•	•	•	•	•	•	•
Gabellager 	 Kontrolle/ Schmierem							•			



Tabelle programmierte Wartungsarbeiten

(*): Die Laufleistung-Coupons können zusammen mit der **obligatorischen** jährlichen Kupon durchgeführt werden

Häufigkeit der Wartungsarbeiten Km (mi)*		0	1000 (600)	Jedes Jahr	15000 (9000)	30000 (18000)	45000 (27000)	60000 (36000)	75000 (45000)	90000 (54000)	105000 (63000)
Coupon		Auslieferung	A	B	C	D	E	F	G	H	
BESCHREIBUNG	ARBEIT										
Hintere Radnabe	Kontrolle / Schmieren der Rollenbehälter				•	•		•	•		•
	Austausch						•			•	
Kettenführung-Schwinge	Kontrolle / Austausch				•	•	•	•	•	•	•
Kettenführung-Rahmenblech	Kontrolle / Austausch				•	•	•	•	•	•	•
Hinterer Stoßdämpfer	Kontrolle / Einstellung		•	•	•	•	•	•	•	•	•
Vorderrad-Gabel 	Kontrolle / Einstellung		•	•	•	•	•	•	•	•	•
	Gabelölwechsel					•		•		•	
Steuersystem der Verdampfungsemissions	Kontrolle / Austausch - Schläuche, Anschlüsse und Kanister					•	•	•	•	•	•
	Kontrolle / Reinigung - Heißluft-Einlass auf dem Kanister					•	•	•	•	•	•
Batterieanschlüsse	Kontrolle und Reinigung				•	•	•	•	•	•	•
Elektrische Anlage	Funktionskontrolle	•	•	•	•	•	•	•	•	•	•
Instrumente	Funktionskontrolle	Vor jedem Fahrtantritt									
	Funktionskontrolle	•	•	•	•	•	•	•	•	•	•



Tabelle programmierte Wartungsarbeiten

(*): Die Laufleistung-Coupons können zusammen mit der **obligatorischen** jährlichen Kupon durchgeführt werden

Häufigkeit der Wartungsarbeiten Km (mi)*		0	1000 (600)	Jedes Jahr	15000 (9000)	30000 (18000)	45000 (27000)	60000 (36000)	75000 (45000)	90000 (54000)	105000 (63000)
Coupon		Auslieferung	A	B	C	D	E	F	G	H	
BESCHREIBUNG	ARBEIT										
Beleuchtung/Blinker	Funktionskontrolle	Vor jedem Fahrtantritt									
	Funktionskontrolle / Austausch	•	•	•	•	•	•	•	•	•	•
Hupe	Funktionskontrolle	Vor jedem Fahrtantritt									
	Funktionskontrolle	•	•	•	•	•	•	•	•	•	•
Scheinwerfer	Funktionskontrolle	Vor jedem Fahrtantritt									
	Einstellung	Bei jeder Änderung an der Fahrzeigrimmung									
Zündschloß	Funktionskontrolle	Vor jedem Fahrtantritt									
	Funktionskontrolle	•	•	•	•	•	•	•	•	•	•
Schlösser	Funktionskontrolle	Vor jedem Fahrtantritt									
	Funktionskontrolle	•	•	•	•	•	•	•	•	•	•
Schrauben und Muttern	Kontrolle / Festziehen	•	•	•	•	•	•	•	•	•	•
Schlauschellen	Kontrolle / Festziehen	•	•	•	•	•	•	•	•	•	•
Allgemeines Schmierien		•	•	•	•	•	•	•	•	•	•
Abnahme Motorrad		•	•	•	•	•	•	•	•	•	•



Tabelle programmierte Wartungsarbeiten

(**): Die Laufleistung-Coupon auf der Kupplung Dragster SCS sind nicht dem **obligatorischen** jährlichen Coupon untergeordnet

Häufigkeit der Wartungsarbeiten Km (mi)**		0	1000 (600)	Jedes Jahr	15000 (9000)	30000 (18000)	45000 (27000)	60000 (36000)	75000 (45000)	90000 (54000)	105000 (63000)
Coupon		Auslieferung	A	B	C	D	E	F	G	H	
BESCHREIBUNG	ARBEIT										
Feststellbremse (Dragster SCS)	Funktionskontrolle	Vor jedem Fahrtantritt									
Automatische Kupplung (Dragster SCS)	Spielkontrolle/-Einstellung	•	•	•	•	•	•	•	•	•	•
Belag Kupplungsscheibe (Dragster SCS) **	Austausch				•	•	•	•	•	•	•
Expansionscheibe Kupplung (Dragster SCS) **	Kontrolle / Rückseite wiederbauen				•		•		•		•
	Austausch					•		•		•	



1.3. Mitgeliefertes Bordwerkzeug und Zubehör

Im Staufach befinden sich die folgendem Inhalt:

- 2 Inbusschlüssel (Sechskant 2,5 mm - 4 mm);
- 1 Exzentrerschlüssel für Hinterrad mit Verlängerung;
- 1 Sicherungsabzieher.

Im Sicherungshalter befinden sich außerdem folgende Ersatzsicherungen (siehe §1.12.1):

- 1 Sicherung (10A);
- 2 Sicherungen (15A);
- 1 Sicherung (25A).





1.4. Schmiermitteltabelle

Beschreibung	Empfohlenes Produkt	Technische Angaben
Motoröl	Motul 7100 4T 5W40 (*)	SAE 5W40
Kühlflüssigkeit	Motul Motocool Factory Line	Produkt mit Monoethylenglykol - Gebrauchsfertige - Kein Verdünnen mit Wasser
Brems- und Kupplungsflüssigkeit	Motul DOT 3 & 4 Brake Fluid	DOT4
Kettenöl	Motul Chain Lube Road	-

* : Damit Sie die empfohlenen Produkte finden und kaufen können, empfiehlt Ihnen MV Agusta sich direkt an die autorisierten Vertragshändler zu wenden. Den Motor des Motorrads Dragster wurde mit dem Motoröl Motul 7100 4T 5W40 entwickelt. Steht das empfohlene Schmiermittel nicht zu Verfügung, rät MV Agusta zum Gebrauch vollständig synthetischer Öle, die die gleichen oder bessere Eigenschaften als folgende Normen haben:

- Konform API SN / SM
- Konform JASO MA2
- Konform SAE 5W40

ANMERKUNG

Die o. a. Spezifizierungen müssen entweder allein oder zusammen mit anderen auf dem Behälter des Motoröl aufgedruckt sein.





1.5. Motoröl - Ölstandkontrolle

Die Ölstandkontrolle muß bei kaltem und abgestelltem Motor vorgenommen werden. Bei warmem Motor muß der Motor seit mindestens zehn Minuten abgestellt sein. Bei der Ölstandkontrolle muss das Fahrzeug auf einem ebenen Untergrund in Fahrtrichtung (senkrecht) stehen.



ACHTUNG: Dieser Vorgang muss von zwei Personen zusammen ausgeführt werden.

Die Öl-Einfüllschraube abschrauben und aus ihrem Sitz nehmen. Den Ölmesstab mit einem sauberen Tuch abwischen und komplett einschrauben, dann es wieder abschrauben, um den Ölstand prüfen.

Der Füllstand muss am Ölmesstab an der Öl-Einfüllschraube bis zwischen die Markierungen MAX und MIN reichen.

Liegt der Ölstand unterhalb der Markierung "MIN", muss Öl nachgefüllt werden (siehe § 1.5.1).



Gefahr - Achtung: Niemals den Motor starten, wenn der Ölstand unter Minimum ist.

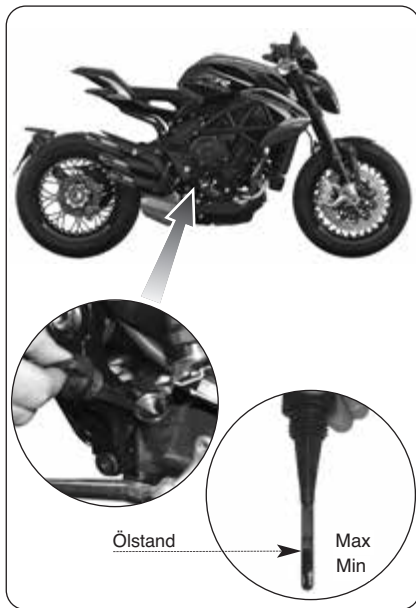



1.5.1. Nachfüllen von Motoröl

Den Ölverschluss aufschrauben. Die nötige Ölmenge bis zum Erreichen des korrekten Einfüllstand einfüllen; in jedem Fall nie das angegebene MAX-Zeichen überschreiten. Am Ende den Motorölstopfen fest schließen.



VORSICHT

Um ein Rutschen der Kupplung und eine Beschädigung des Motors zu vermeiden, niemals chemische Ölzusätze oder ein anderes als das in § 1.4. angegebene Öl verwenden. Sicherstellen, dass beim Nachfüllen keine Fremdkörper in das Motorgehäuse gelangen.



**ACHTUNG**

Frischöl und Altöl können gefährlich sein. Die Einnahme von Frischöl und Altöl ist für Personen und Haustiere gefährlich. Bei Einnahme von Motoröl sofort einen Arzt benachrichtigen und kein Erbrechen auslösen, um ein Einatmen des Produktes in die Lungen zu vermeiden. Ein ständiger Kontakt mit Motoröl kann Hautkrebs verursachen. Ein kurzer Kontakt mit Motoröl kann Hautreizungen verursachen.

- Frischöl und Altöl von Kindern und Haustieren fernhalten.
- Beim Nachfüllen von Motoröl langärmelige Kleidung und wasserundurchlässige Schutzhandschuhe anziehen.
- Bei Hautkontakt mit Motoröl die betroffenen Stellen mit reichlich Wasser und Seife waschen.
- Das Altöl muss entsprechend der gesetzlichen Vorschriften entsorgt oder recycelt werden.



1.6. Kühlflüssigkeit - Kontrolle Kühlflüssigkeitsstand

Die Kontrolle des Kühlflüssigkeitsstands muß bei kaltem und abgestelltem Motor vorgenommen werden. Bei der Kontrolle des Kühlflüssigkeitsstands muss das Fahrzeug auf einem ebenen Untergrund in Fahrtrichtung (senkrecht) stehen.

Der Füllstand muss sich leicht oberhalb der Markierung MIN befinden (siehe Abbildung).

Liegt der Kühlflüssigkeitsstand unterhalb der Markierung "MIN", muss Kühlflüssigkeit nachgefüllt werden (siehe § 1.6.1).



ACHTUNG

Das Motorrad auf keinen Fall nutzen, wenn der Kühlflüssigkeitsstand unter der Markierung MIN liegt.

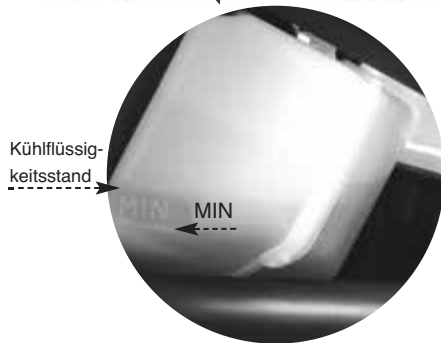



1.6.1. Kühlflüssigkeit - Nachfüllen von Kühlflüssigkeit

Den Kühlmittel-Tankdeckel abschrauben und entfernen. Mit einer Spritze, die in § 1.4 angegebene Kühlflüssigkeit einfüllen.



ACHTUNG: Die Kühlflüssigkeit darf nur bei kaltem Motor nachgefüllt werden. Um Verbrühungsgefahr zu vermeiden, niemals den Deckel aufschrauben, solange der Motor noch warm ist. Der Kühlkreislauf steht unter Druck!

Nach dem Auffüllen die vorher abgebauten Teile sorgfältig wieder anbauen.





ACHTUNG

Unter bestimmten Voraussetzungen kann sich die Kühlflüssigkeit entzünden und mit unsichtbarer Flamme brennen. Darauf achten, dass keine Kühlflüssigkeit auf heiße Motorteile gelangt. Bei Entzünden der Kühlflüssigkeit besteht Verbrennungsgefahr.



ACHTUNG

Kühlflüssigkeit ist giftig. Der Kontakt mit der Kühlflüssigkeit kann Hautverätzungen und Hautreizungen verursachen. Kühlflüssigkeit von Kindern und Haustieren fernhalten. Bei ungewollter Einnahme von Kühlflüssigkeit kein Erbrechen hervorrufen, um ein Einatmen des Produktes in die Lungen zu vermeiden. Bei Kontakt mit Augen oder Haut sofort mit reichlich Wasser abspülen und umgehend einen Arzt aufsuchen.



VORSICHT

Zum Auffüllen des Kühlflüssigkeitsstands und/oder Wechsel des Kühlflüssigkeit ausschließlich das in der Tabelle § 1.4 angegebene Produkt verwenden. Mischen Sie noch verdünnen Sie das Kühlmittel nicht mit Zusätzen oder unterschiedlichen Flüssigkeiten. Wenn das Kühlmittel spezifiziert in der Tabelle § 1.4 ist nicht vorhanden, benutzt ein Kühlmittel mit den technischen Eigenschaften, die mit dem vorgeschriebenen Produkt gleichbleibend sind.



VORSICHT

Kühlflüssigkeitsspritzer können lackierte Oberflächen beschädigen. Beim Auffüllen des Kühlkreislaufes darauf achten, dass keine Kühlflüssigkeit verspritzt wird. Eventuell verspritzte Kühlflüssigkeit sofort mit einem sauberen Tuch aufwischen.



DE 1

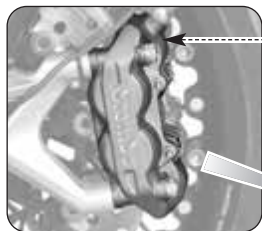

Vordere Bremszange



Hintere Bremszange

Brems Scheibe

Bremsbeläge

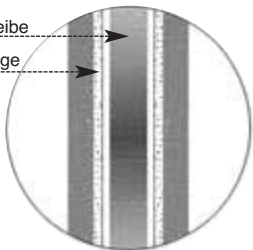

Abnutzungsgrenzwert 1 mm



1.7. Bremsbeläge - Kontrolle Abnutzung / Verschleiß

Die Tiefe der Schicht des Friktionsmaterials der Bremsbeläge muss regelmäßig überprüft werden. Die Tiefe der Schicht des Friktionsmaterials der Bremsbeläge darf nie weniger als 1 mm betragen.

Gefahr – Achtung: Wird das Motorrad mit abgenutzten Bremsbelägen gefahren, lässt die Bremswirkung nach, die Unfallgefahr wird größer. Ist die Bremsbelagstärke bis nahe der Abnutzungsgrenze verschlissen, wenden Sie zum Austausch der Bremsbeläge sich an einen autorisierten Kundendienst. Nach dem Auswechseln der Bremsbeläge auf eine entsprechende Einfahrzeit achten.



Bremsflüssigkeitsbehälter Hinterradbremse

Bremsflüssigkeitsbehälter Vorderradbremse



1 DE

1.8. Bremsflüssigkeit - Kontrolle Bremsflüssigkeitsstand



ACHTUNG

Bei fehlender Kontrolle oder unzureichender Wartung erhöht sich die Unfallgefahr. Vor jedem Fahrtantritt die Bremsanlage wie nachstehenden Anweisungen überprüfen.

Ein leichtes Abfallen des Bremsflüssigkeitsstandes ist durch die Abnutzung der Bremsbeläge bedingt und daher normal. Der Bremsflüssigkeitsstand muss auf alle Fälle zwischen den Markierungen MIN und MAX liegen. Ist der Bremsflüssigkeitsstand unter das Zeichen MIN gefallen, wenden Sie sich an einen Kundendienst, um die Bremsanlage überprüfen zu lassen.

**ACHTUNG**

Das Motorrad nicht benutzen, wenn der Bremsflüssigkeitsstand unter die Markierung MIN abgefallen ist. Unter diesen Umständen kann es passieren, dass die Bremsanlage nicht richtig funktioniert. Es besteht erhöhte Unfallgefahr. Sie können die Kontrolle über das Fahrzeug verlieren. Ist der Bremsflüssigkeitsstand unter die Markierung MIN abgefallen, wenden Sie sich zum Überholen der Bremsanlage an einen MV Agusta Vertragshändler.

**ACHTUNG**

Das Nachfüllen von Bremsflüssigkeit darf nur von autorisiertem Fachpersonal vorgenommen werden. Die Bremsflüssigkeit ist giftig und kann bei Einnahme tödlich sein. Der Kontakt mit der Bremsflüssigkeit kann Hautverätzungen und Hautreizungen verursachen. Bremsflüssigkeit von Kindern und Haustieren fernhalten. Bei ungewollter Einnahme von Bremsflüssigkeit kein Erbrechen hervorrufen, um ein Einatmen des Produktes in die Lungen zu vermeiden. Bei Kontakt mit Augen oder Haut

sofort mit reichlich Wasser abspülen und umgehend einen Arzt aufsuchen.

**ACHTUNG**

Zum Auffüllen des Bremsflüssigkeitsstands ausschließlich die in der Tabelle § 1.4 angegebene Bremsflüssigkeit verwenden. Ein eventuelles Mischen unterschiedlicher Bremsflüssigkeiten kann gefährliche chemische Reaktionen verursachen und die Bremswirkung verringern, dadurch erhöht sich die Unfallgefahr.

**ACHTUNG**

Bei einem zu niedrigen Bremsflüssigkeitsstand kann Luft in die Bremsanlage eindringen, die Bremswirkung lässt nach und die Unfallgefahr wird größer. Luft in der Bremsanlage kann dadurch bemerkt werden, dass die Betätigung des Bremshebels "schwammiger" erscheint. Bei Luft in der Bremsanlage muss die Bremsanlage vor einem neuen Einsatz des Fahrzeugs bei einem MV Agusta Vertragshändler entlüftet werden.



1.9. Flüssigkeit Kupplungsbetätigung - Kontrolle Flüssigkeitsstand

Der Flüssigkeitsstand für die Kupplung muß zwischen den Zeichen MAX und MIN liegen. Ist der Flüssigkeitsstand für die Kupplung unter das Zeichen MIN gefallen, wenden Sie sich an einen Kundendienst, um die Kupplungsanlage überprüfen zu lassen.



ACHTUNG

Das Motorrad niemals benutzen, wenn der Flüssigkeitsstand für die Kupplung unter die Markierung MIN abgefallen ist. Die Kupplung könnte nicht richtig funktionieren. Es besteht erhöhte Unfallgefahr. Sie können die Kontrolle über das Fahrzeug verlieren. Ist der Flüssigkeitsstand für die Kupplung unter die Markierung MIN abgefallen, wenden Sie sich zum Überholen der Kupplungsanlage an einen MV Agusta Vertragshändler.



ACHTUNG

Zum Auffüllen des Flüssigkeitsstands für die Kupplung ausschließlich die in der Tabelle § 1.4 angegebene Kupplungsflüssigkeit verwenden.





1.10. Reifen – Kontrolle und Wechsel



ACHTUNG

Vor Fahrtantritt stets den Reifendruck und Abnutzungszustand der Reifen überprüfen.

Die Kontrolle des Reifendrucks ist von grundlegender Bedeutung für die Fahrsicherheit. Bei einem zu niedrigen Reifendruck kann das Fahrzeug schwerer gelenkt werden und die Reifen verschleiben schneller. Bei einem zu hohen Reifendruck verringert sich die Auflagefläche des Reifens und damit die Straßenhaftung.

Vor jedem Fahrtantritt muss daher stets der Reifendruck bei Raumtemperatur geprüft werden. D. h. das Motorrad muss seit mindestens drei Stunden geparkt sein.



ACHTUNG

Ein falscher Reifendruck bedeutet große Gefahr beim Fahren. Bei zu niedrigem Reifendruck kann der Reifen auf der Felge rutschen und sich von ihr ablösen. D. h. der Reifen wird völlig platt und Sie können die Kontrolle über das Fahrzeug verlieren.



Fahrt gemessen, erhalten Sie höhere als die tatsächlichen Druckwerte. Dadurch könnte der Reifendruck falsch eingestellt werden. Beim Einstellen des Reifendrucks müssen die in § 3.2. angegebenen und auf dem Etikett auf der Federteller der rechten Gabel angewendet. Vor längeren Fahrten kann der Nominaldruck um 0,2 Bar erhöht werden.

Sehr wichtig ist die Kontrolle des Reifenzustands vor Fahrtantritt. Stark abgenutzte Reifen sind anfälliger gegen Löcher und verschlechtern die Lenkbarkeit und die Stabilität des Motorrads. Bei der Überprüfung des Reifenzustands muss die Profiltiefe kontrolliert werden. Die Profiltiefe darf nicht geringer als die durch die Straßenverkehrsordnung angegebenen Werte sein. Am Boden der Profile dürfen keine Risse zu sehen sein. Die Reifendecke muss frei von Nägeln und Glassplittern sein. Die Reifenwände dürfen keine Risse aufweisen. Sind diese Voraussetzungen nicht gegeben, muss der Reifen umgehend bei einem MV Agusta Vertragshändler gewechselt werden.



ACHTUNG

Die vorgeschriebene Profiltiefe kann von Land zu Land unterschiedlich sein. Es müssen stets die vom jeweiligen Land gesetzlich vorgeschriebenen Werte eingehalten werden.



ACHTUNG

- Stark verschlissene Reifen von einem MV Agusta Vertragshändler wechseln lassen. Das Fahren des Motorrads mit stark abgenutzten Reifen ist illegal, die Fahrstabilität verringert sich. Sie können die Kontrolle über das Fahrzeug verlieren.
- Bei Schäden oder einem Loch im Reifen muss der Reifen gewechselt und nicht repariert werden. Ein reparierter Reifen bietet im Vergleich zu einem neuen Reifen nur eingeschränkte Leistungen und ein geringeres Sicherheitsniveau.



Wird der Reifen provisorisch oder notdürftig repariert, muss bis zum nächstgelegenen MV Agusta Vertragshändler langsam und sehr vorsichtig gefahren werden. Lassen Sie dort den Reifen sofort wechseln. Nach einer Reifenreparatur nie schneller als 60 km/h fahren. Der Reifen kann nicht repariert werden, wenn die Reifenwand beschädigt oder das Loch auf der Lauffläche größer als 6 mm ist.

- Bei der provisorischen Reparatur eines Lochs im Reifen rät MV Agusta vom Gebrauch flüssiger Abdichtungsmittel ab. Diese Abdichtungsmittel können negative auf die einzelnen Schichten des Reifens einwirken und Nebenschäden, die durch eventuelle eingedrungene Gegenstände verursacht wurden, verstecken.

- Zum Reifenwechsel nur die in § 3.2. angegebenen Reifen verwenden. Unbedingt den Einsatz unterschiedlicher Reifenmarken und Profile an Vorder- und Hinterrad vermeiden. Der Einsatz ungeeigneter Reifen beeinträchtigt die Lenkbarkeit und Stabilität des Motorrads. Es besteht erhöhte Unfallgefahr.
- Die Felgen wurden für schlauchlose Reifen (Tubeless) entwickelt. Niemals Schlauchreifen an Felgen für schlauchlose Reifen abringen. Felgenreänder und Reifenwulst können sich dann nicht richtig setzen. Die Reifen rutschen auf den Felgen und können den Druck verlieren. Sie können die Kontrolle über das Fahrzeug verlieren.



- Niemals Luftschläuche in einen schlauchlosen Reifen einbauen. Die Überhitzung des Reifens kann zum Platzen des Luftschlauchs führen. Die Reifen verlieren den Druck und Sie können die Kontrolle über das Fahrzeug verlieren.
- Beim Aufziehen der Reifen muss auf die durch Pfeile auf der Reifenwand angezeigte Laufrichtung geachtet werden.

- Neue Reifen benötigen eine Einlaufzeit, um ihre komplette Effizienz zu erreichen. Während der Einlaufzeit ist die Reifenhaftung bei bestimmten Straßenbelägen geringer. Wir empfehlen Ihnen daher während der ersten 100 km Fahrt mit einem neuen Reifen langsamer zu fahren.



❑ Ausbau des Hinterrads



Vorsicht – Vorsichtsmassnahme:
Muss der Reifen bei einem Reifenhändler gewechselt werden, sicherstellen, dass für den Aus- und Einbau folgende Werkzeuge verwendet werden:

- 55 mm Steckschlüssel
- Drehmomentschlüssel

Werden andere Werkzeuge benutzt, können Radbauteile schwer beschädigt werden. Wir raten davon ab Reifenwechsel in schlecht ausgerüsteten Werkstätten vornehmen zu lassen. Es ist auf alle Fälle ratsamer sich für einen Reifenwechsel an einen MV Agusta Vertragshändler zu wenden.

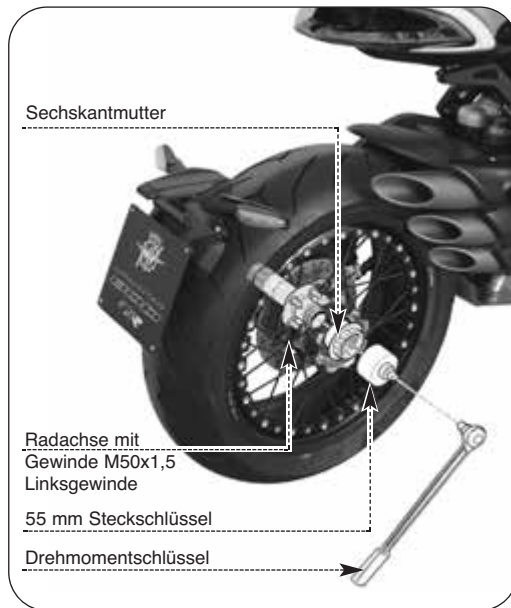



☐ Radkontrolle

Vor Fahrtantritt stets die Radfelge auf Risse, Verbiegungen und Verformungen überprüfen.



ACHTUNG

Werden Schäden festgestellt, muss das Rad von einem MV Agusta Vertragshändler gewechselt werden. Niemals versuchen auch nur kleine Schäden an den Rädern selbst zu beheben. Bei einem Reifenwechsel oder Austausch der Felge muss das Rad bei einem MV Agusta Vertragshändler ausgewuchtet werden. Ein nicht richtig ausgewichtetes Rad schränkt die Fahrzeugleistung und die Lebensdauer der Reifen ein.



ACHTUNG

Beim Auswuchten der Räder ausschließlich zugelassene Ausgleichsgewichte verwenden. Keine flüssigen Ausgleichs- oder Dichtungsmittel verwenden.



ACHTUNG

Niemals versuchen einen schlauchlosen Reifen ohne das entsprechende Spezialwerkzeug und Schutzvorrichtungen für die Felgen abzubauen. Andernfalls besteht die Gefahr, dass die Dichtungsfläche an der Felge beschädigt wird. Dadurch verliert der Reifen Luft und Sie die Kontrolle über das Fahrzeug.



1.11. Kette - Kontrolle und Schmieren

Für diese Arbeit muss das Motorrad auf ebenem Untergrund auf den hinteren Ständer gestellt und der Leerlauf eingelegt werden.

□ Kontrolle der Kettenspannung



ACHTUNG: Vor der Überprüfung der Kettenspannung, wenden Sie sich an den MV Agusta Kundendienst, um zu überprüfen, daß der Wert der statischen Einstellung der hinteren Federung korrekt ist. Auch überprüfen, ob die Kette richtig geschmiert wird.

Der untere Teil der Kette muss einem Abstand von **116 mm** vom unteren Kettenschutz haben. Die Kontrolle an mehreren Stellen an der Kette ausführen. Dazu muss das Hinterrad von Hand gedreht werden. Der Abstand muss während der Raddrehung gleich bleiben. Bestehen starke Unterschiede beim Spiel an der Kette, bedeutet dies, dass einige Kettenglieder gequetscht, verklemmt oder gedehnt sind. Ist der Abstand der Kette zum Kettenschutz kleiner oder größer als 116 mm, muss die Kettenspannung eingestellt werden.

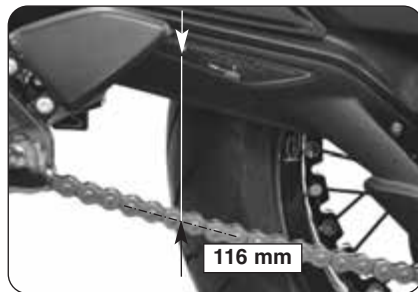



ACHTUNG

Beim Fahren des Motorrads mit einer verschlissenen oder schlecht eingestellten Kette erhöht sich die Unfallgefahr. Vor jedem Fahrtantritt prüfen, ob die Kettenspannung den Angaben in diesem Kapitel entspricht. Zum Einstellen der Kettenspannung wenden Sie sich bitte an einen MV Agusta Vertragshändler.



ACHTUNG

Bei gequetschten, verklemmten oder gedehnten Kettengliedern, muss die Kette durch eine MV Agusta Vertragshändler ersetzt werden.



ACHTUNG

Bei Schäden oder starker Abnutzung der Kette oder der entsprechenden Zahnräder muss die Kette durch einen MV Agusta Vertragshändler ausgetauscht werden. Bei jedem Kettenwechsel müssen auch die entsprechenden Zahnräder ausgetauscht werden.



ACHTUNG

Der Einbau einer Kette mit Kettenschloss ist gefährlich. Ein nicht richtig vernietetes Kettenglied oder Kettenschloss kann sich öffnen und Unfälle oder schwere Motorschäden verursachen. Niemals Ketten mit Kettenschlössern verwenden.



ACHTUNG

Jedesmal wenn es verlangt wird, um die Hinterradnabenschrauben laufen zu lassen, wenden Sie an einen autorisierten MV Agusta Kundendienst. Wenn Sie die Schrauben festziehen, wenden Sie ein Drehmoment an, die dem Wert gleich ist, der im Aufkleber auf dem Schwinge gezeigt wird. Die Anwendung einer Drehkraft stark als der angezeigte Wert kann den schnellen Zerfall der hintere Radnabe verursachen und die Zuverlässigkeit des Fahrzeugs und die Sicherheit des Piloten und des Passagiers gefährden.



☐ Schmieren

Damit die Kette richtig funktioniert, muss sie richtig geschmiert werden.

► Vorbereitende Reinigung: vorm Schmieren der Kette müssen alle Schmutzablagerungen an der Kette mit Kerosin aufgelöst werden. Diese Schmutzreste können anschließend mit einem sauberen Tuch bzw. einem Pressluftstrahl entfernt werden.



Vorsicht – Vorsichtsmassnahme: Die Kette ist eine Kette mit Dichtringen (O-Ringen). Um Schäden an der Kette zu vermeiden, darf diese nie mit Hochdruck-Dampf- oder Wasserstrahl gereinigt werden. Es dürfen auch kein Benzin oder handelsübliche Reinigungsmittel verwendet werden. Die Kette darf nur mit Kerosin gereinigt werden.



ACHTUNG

Kerosin kann gefährlich sein. Kerosin ist entzündlich. Der Kontakt mit Kerosin kann für Kinder und Haustiere schädlich sein. Offene Flammen und heiße Gegenstände vom Kerosin fernhalten. Kinder und Haustier vom Kerosin fernhalten. Benutztes Kerosin muss entsprechend der gesetzlichen Vorschriften entsorgt werden.



► **Schmieren:** einen leichten und gleichmäßigen Film des angegebenen Schmiermittels auf der gesamten Kette auftragen. Sorgfältig darauf achten, dass die umliegenden Fahrzeugteile, wie z. B. die Reifen, nicht verschmutzt werden. Den Strahl des Schmiermittels auf den internen Verbindungen verweisen, zwecks die Oberfläche der O-Ringe schmieren und innerhalb der Kettenrolle eindringen.



Vorsicht – Vorsichtsmassnahme:

Ausschließlich das in der Tabelle § 1.4. angegebene Schmiermittel verwenden, um die Antriebskette zu schützen und zu vermeiden die Ölspritzern, wenn das Fahrzeug in Bewegung ist.



ACHTUNG: Das Schmieren der Kette muss in den in der Tabelle des Wartungsprogramms (§ 1.2.) angegebenen Abständen erfolgen. Die Kette muss auch nach Fahrten bei Regen oder nach einer Fahrzeugreinigung geschmiert werden. Bei Fahrten mit nicht oder mit nicht ausreichend geschmierter Kette besteht Unfallgefahr.

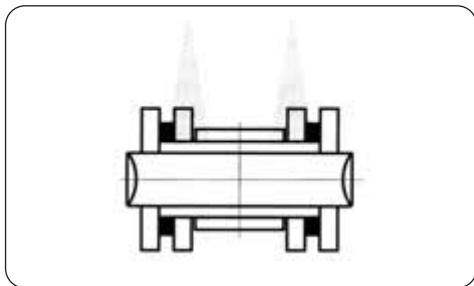



DE
1

1.12. Leerlaufdrehzahl - Kontrolle

Die Kontrolle der Leerlaufdrehzahl muß mit Motor bei Betriebstemperatur ausgeführt werden.

Die Leerlaufdrehzahl muß zwischen 1250 und 1350 U/min liegen.

Wenden Sie sich zum Einstellen der Leerlaufdrehzahl an einen Kundendienst.





1.13. Steuersystem der Verdampfungs-emissions

Die Motorräder **MV Agusta DRAGSTER** sind mit einem Steuersystem der Verdampfungs-emissions ausgestattet, um das Entweichen von Kraftstoffdämpfen aus dem Kraftstofftank zu verhindern. Um die Effizienz und Zuverlässigkeit des Gerätes zu gewährleisten, ist es notwendig, die folgenden Operationen durch einen autorisierten MV Agusta Vertragshändler durchgeführt zu haben.

Kontrolle (und notfalls Austausch)

Schläuche und Anschlüsse
Kanister

Kontrolle (und notfalls Reinigung)

Heißluft-Einlass



VORSICHT



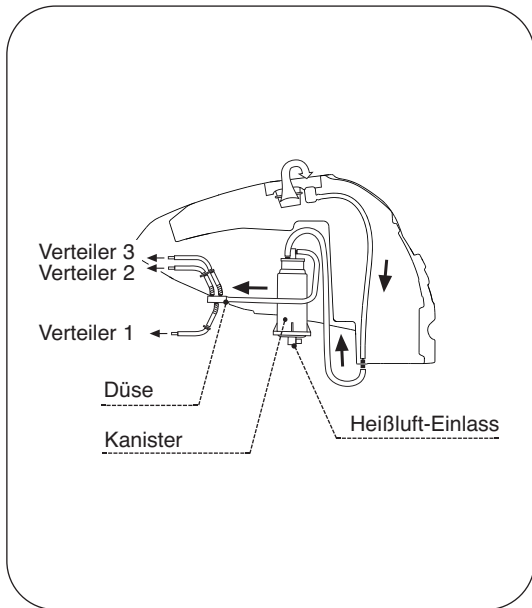





Die oben erwähnten Operationen müssen in den in der Tabelle des Wartungsprogramms (§ 1.2.) angegebenen Abständen erfolgen.





1.14. Auswechseln - Allgemeine Informationen

Das Auswechseln der Sicherungen und der Glühbirnen (Ausnahme sind die in der Tabelle durch das Symbol  gekennzeichneten), kann vom Fahrer selbst ausgeführt werden. Dazu genau die Anweisungen einhalten.

	Sicherung Batterieladung - Auswechseln (§1.14.1.)
	Sicherungen Stromverbraucher - Auswechseln (§1.14.1.)
	Fahrlicht - Auswechseln der Birne (§1.14.2.)
	Fernlicht - Auswechseln der Birne (§1.14.3.)
	Blinkern - Auswechseln
	Nummernschildbeleuchtung - Auswechseln
	Rücklicht - Auswechseln
	Bremslicht - Auswechseln

1.14.1. Sicherungen - Auswechseln

► Die Nachladungs-Sicherung befindet auf der Fernschalter auf der rechten Seite des Motorrads; siehe Position in der Abb.

So erreichen Sie die Sicherung die Schutzkappe entfernen, durch Entfernen der zwei Schrauben.

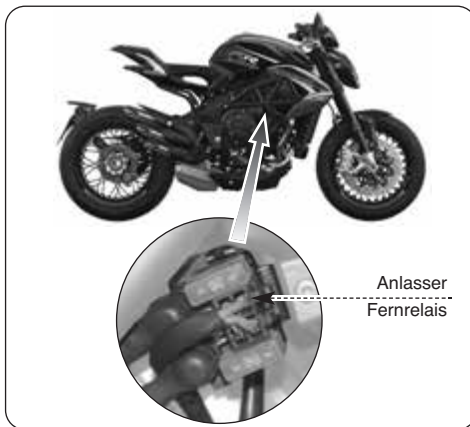



VORSICHT

Vor der Kontrolle oder Wechseln der Sicherungen muss der Zündschlüssel auf "OFF" gedreht werden, um Kurzschluss und die dadurch bedingte Beschädigung elektrischer Bauteile zu vermeiden.

- Um die Sicherung zu ersetzen, wechseln Sie die Sicherung für die Batterieladung mit der Ersatzsicherung.



ACHTUNG

Niemals eine andere Sicherung als mit der vorgeschriebenen Leistung verwenden, um Schäden an der Elektroanlage des Fahrzeugs und Brandgefahr zu vermeiden.

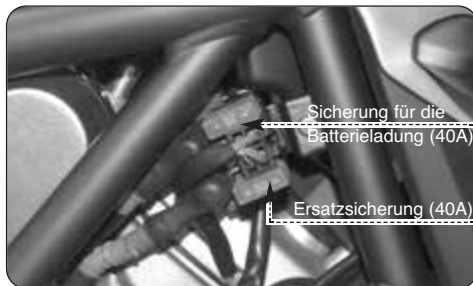



- ▶ Die Sicherungen der Stromverbraucher befinden sich auf der rechten Seite.
- ▶ Den Deckel des Sicherungshalters aushaken und anheben.



VORSICHT

Vor der Kontrolle oder Wechseln der Sicherungen muss der Zündschlüssel auf "OFF" gedreht werden, um Kurzschluss und die dadurch bedingte Beschädigung elektrischer Bauteile zu vermeiden.





► Die Sicherungsfunktion und position unter dem Deckel des Sicherungskasten und im beiliegenden elektrischen Schaltplan angegeben befindet. Die Markierungsbuchstaben in der Abbildung entsprechen den Angaben im Schaltplan.

Nicht vergessen, im Sicherungskasten drei Ersatzsicherungen befinden.

► Die durchgebrannte Sicherung auswechseln und den Deckel wieder aufsetzen.



ACHTUNG

Niemals eine andere Sicherung als mit der vorgeschriebenen Leistung verwenden, um Schäden an der Elektroanlage des Fahrzeugs und Brandgefahr zu vermeiden.

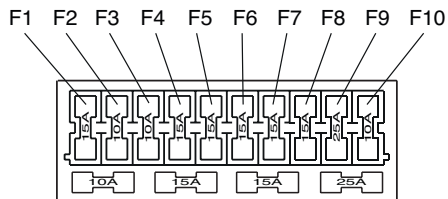



1.14.2. Fahrlicht - Auswechseln der Birne

► Die vier Befestigungsschrauben des Scheinwerfers (zwei auf der rechten Seite und zwei auf der linken Seite des Motorrades) abschrauben.



► Bevor der Scheinwerfer vom Motorrad herausgezogen wird, den Stecker auf der Rückseite des Scheinwerfers und die Stecker der vorderen Blinker trennen.

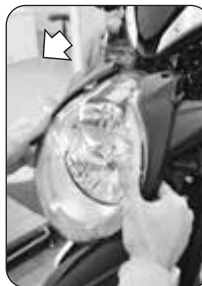



- ▶ Zur Durchführung folgender Operationen, das Scheinwerfer auf einen Tisch legen.
- ▶ Die Schutzhaube entfernen.
- ▶ Den Stecker des Fahrlicht-Lampe gegen den Uhrzeigersinn drehen.
- ▶ Die Birne herausziehen.
- ▶ Die Kabelstecker vom Birne trennen.



Vorsicht-Vorsichtsmaßnahme: Das Lampenglas nicht mit bloßen Fingern anfassen. Andernfalls mit Fettlöser reinigen.

- ▶ Den Kabelstecker am einer neuen Birne anschließen.
- ▶ Die neue Birne einsetzen.
- ▶ Den Stecker in Uhrzeigersinn drehen.
- ▶ Die Schutzhaube wieder anbringen. Stellen Sie sicher, den Positionsbezügen richtig zu platzieren.
- ▶ Den Stecker am Scheinwerfer und die Stecker der vorderen Blinker anschließen.
- ▶ Den Scheinwerfer auf dem Motorrad einsetzen und die vier Befestigungsschrauben festschrauben. Die Kabel in den Seitensitzen richtig legen.

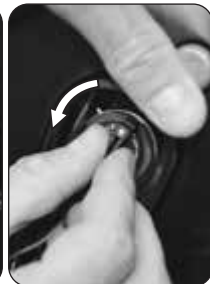

1 DE

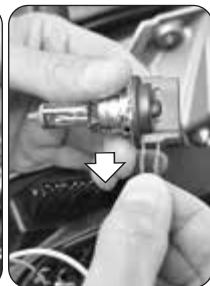



1.14.3. Fernlicht - Auswechseln der Birne

- ▶ Den Scheinwerfer aus dem Motorrad, wie in Abschnitt §1.13.2. beschrieben, entfernen.
- ▶ Die Rückhaltefeder des Fernlicht-Lampe aushaken.
- ▶ Die Birne herausziehen.
- ▶ Den Kabelstecker vom Birne trennen.



Vorsicht-Vorsichtsmaßnahme: Das Lampenglas nicht mit bloßen Fingern anfassen. Andernfalls mit Fettlöser reinigen.

- ▶ Den Kabelstecker am einer neuen Birne anschließen.
- ▶ Die neue Birne einsetzen. Stellen Sie sicher, den Positionsbezügen richtig zu platzieren.
- ▶ Die Rückhaltefeder wieder einhaken.
- ▶ Den Scheinwerfer auf dem Motorrad, wie in Abschnitt §1.13.2. beschrieben, wieder einbauen.

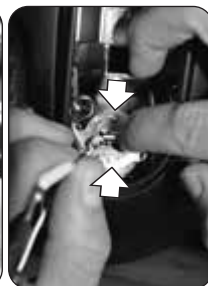



1.15. Batterie

Dieses Motorrad ist mit einer versiegelten (wartungsfreien) Batterie ausgestattet, die unter dem Heckteil angebracht ist. Die Batterie ist wartungsfrei, d. h. der Batteriefüllstandsstand braucht nicht überprüft bzw. nachgefüllt werden.

Bei schwacher bzw. entladener Batterie (elektrische Probleme, Startschwierigkeiten), muss die Batterie so bald wie möglich aufgeladen werden. Zum Aufladen der Batterie das Batterie-Ladegerät an den entsprechenden Kabelstecker unterhalb der Beifahrer-Sitzbank anschließen. Beachten Sie, dass die Batterie sich schneller entlädt, wenn elektrisches Sonder-Zubehör installiert wurde.



ACHTUNG

Ist das Batteriegehäuse beschädigt, kann Schwefelsäure austreten. Schwefelsäure ist giftig und stark ätzend. Jeglichen Kontakt mit Haut, Augen und Kleidung vermeiden. Bei Arbeiten an oder in der Nähe der Batterie stets eine Schutzbrille tragen.

Bei Kontakt mit Schwefelsäure muss wie folgt ERSTE HILFE geleistet werden:

- **ÄUßERLICHER KONTAKT:** mit reichlich fließendem Wasser abspülen.
- **INNERLICHER KONTAKT:** Grosse Mengen Wasser oder Milch trinken und sofort einen Arzt benachrichtigen.
- **AUGEN:** Mindestens 15 Minuten mit Wasser spülen und sofort einen Arzt aufsuchen.

Bei Austreten von Schwefelsäure bildet sich Wasserstoffgas, das bei offenen Flammen oder Funkenbildung explodieren kann.

Zum Wechseln der Batterie wenden Sie sich bitte an einen autorisierten MV Agusta Kundendienst.



DE
1

Längeres Stilllegen

Soll das Fahrzeug für einen längeren Zeitraum (einen Monat oder mehr) nicht benutzt werden, sollte die Sicherung für die Batterieladung ausgebaut werden (siehe §1.14.1). Um eine lange Haltbarkeit der Batterie zu garantieren, sollte die Batterie bei längerem Stillstand einmal pro Monat aufgeladen werden.

Zum Aufladen der Batterie das Ladegerät an den entsprechenden Kabelstecker unterhalb der Beifahrer-Sitzbank anschließen, mit dem Aufladen-Sicherung im Anlasser Fernrelais eingesetzt.

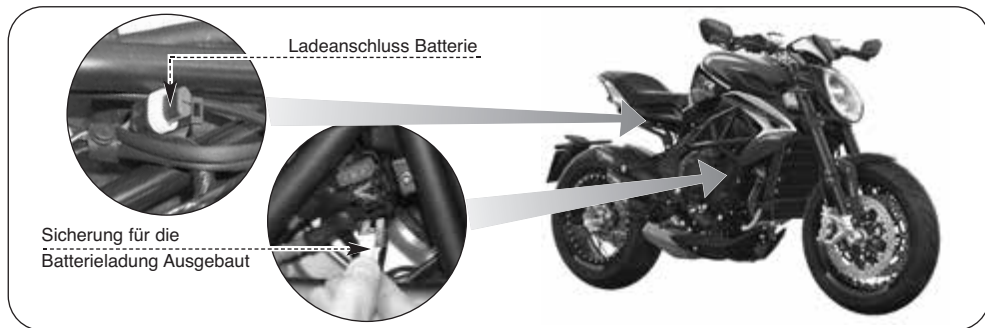



1.16. Fahrzeugpflege

Eine regelmäßige Pflege ist wichtig, damit Ihr Motorrad über lange Zeit seinen Wert behält. Lack- und andere Oberflächen müssen gepflegt und geschützt werden. Stets auf eventuelle Schäden, Abnutzung und Austreten ätzender Flüssigkeiten achten.



Vorsicht – Vorsichtsmassnahme: Vorm Waschen müssen die Auspuffenden verstopft und die elektrischen Teile geschützt werden.



ACHTUNG: Ist das Motorrad noch von der letzten Fahrt warm, muss abgewartet werden, bis sich der Motor und die Auspuffanlage abgekühlt haben.



Vorsicht – Vorsichtsmassnahme: Keine Hochdruck-Wasserstrahl oder Dampfreinigungsgeräte verwenden, da andernfalls Wasser in Motorradbauteile eindringen und diese beschädigen kann.



ANMERKUNG: Die Reinigungsmittel verunreinigen die Umwelt. Aus diesem Grund sollte die Fahrzeugreinigung in Bereichen, die mit Sammlungs- und Klärungsanlagen der Reinigungswasser ausgestattet sind, vorgenommen werden.



DE 1 Mit Wasser, Schwamm und einem milden Reinigungsmittel säubern. Mit einem weichen Tuch abtrocknen. An schwer zugänglichen Stellen einen Druckluftstrahl verwenden.



Vorsicht – Vorsichtsmassnahme:

- Sicherstellen, dass keine Tücher oder Schwämme benutzt werden, die vorher für scharfe Reinigungs- und Scheuermittel bzw. für Lösungsmittel oder Benzin verwendet wurden.
- Um nicht-reparierbare Schäden an der Karosseriebauteile zu vermeiden, laugen- oder säurehaltigen Reinigungsmittel, Benzin, Bremsflüssigkeit oder andere Lösungsmittel verwenden nicht. Das Karosserie-Bauteile ausschließlich mit einem weichen Tuch, lauwarmem Wasser und einem milden Reinigungsmittel säubern.
- Wenn du Zweifel über den chemischen Aufbau von hast Reinigungsmittel, prüfen seinen Effekt, indem es ihn auf einem wenig Bereich der Karosserie anwendet, bevor es sie auf dem vollständigen Motorrad verwendet.

Die lackierten Teile müssen in regelmäßigen Abständen mit Spezialprodukten behandelt werden. Bei Fahrten auf Straßen, auf denen Streusalz

ausgebracht wurde, muss das Motorrad so bald wie möglich gereinigt werden. Dann ausschließlich mit kaltem Wasser waschen. Warmes Wasser verstärkt die Korrosionswirkung.



ACHTUNG: Sicherstellen, dass kein Öl oder Wachs auf die Bremsen oder Reifen gelangt. Gegebenenfalls die Bremsscheiben mit einem Reinigungsmittel für Bremsscheiben oder Aceton reinigen und die Reifen mit heißem Wasser und einem milden Reinigungsmittel waschen.



ACHTUNG: Bei nassen Bremsen verringert sich die Bremsleistung und erhöht sich die Unfallgefahr. Nach dem Waschen des Fahrzeugs den Motor starten und langsam einige Minuten fahren. Einige Male vorsichtig bremsen, so dass die Bremsscheiben und Bremsbeläge trocknen können.









ACHTUNG: Die Antriebskette muss sofort nach der Reinigung und Trocknen des Fahrzeugs geschmiert werden. Das Schmieren der Kette muss entsprechend der Angaben in § 1.11. der vorliegenden Wartungsanleitung vorgenommen werden.



1.17. Längeres Stilllegen

Soll das Fahrzeug über längere Zeit stillgelegt werden, müssen folgende Vorkehrungen getroffen werden:

-  Den Benzintank entleeren.
-  Den Sicherung batterie-laden entfernen (§1.14.1). Den Batterie einmal im Monat laden (§1.15.).
-  Die Kerzenstecker abziehen und die Zündkerzen ausbauen. Einen Teelöffel Motoröl in jede Kerzenbohrung einfüllen, anschließend die Kerzen wieder einbauen und die Kerzenstecker aufsetzen und den Motor einige Umdrehungen ausführen lassen.
-  Alle Bowden- und Seilzüge sowie die Drehpunkte der Hebel und Pedale schmieren.
-  Das Motorrad reinigen und die lackierten Teile mit Spezialprodukten behandeln (§1.16.).
-  Um die Integrität und Leistung der Reifen zu garantieren, sollte das Fahrzeug an einem kühlen, trockenen und dunklen Raum mit gleichbleibender Temperatur unter 25°C abgestellt werden. Die Reifen dürfen keinen direkten Kontakt mit Heizkörpern oder Heizungsleitungen und keinen längeren Kontakt mit Öl oder Benzin haben. Die Reifen sollten nicht in der Nähe von Elektromotoren oder Geräten aufbewahrt werden, bei denen elektrische Funkenbildung oder elektrische Entladungen entstehen. Während der Stillstandszeit muss das Motorrad auf den hinteren Ständer gestellt werden.
-  Das Motorrad mit einer zweckmäßigen Schutzplane abdecken.

Einsatz nach dem Stilllegen muß eine allgemeine Fahrzeugkontrolle vorgenommen und gegebenenfalls die entsprechenden Wartungsarbeiten (§1.2.) ausgeführt werden.



2.1. Position des Diagnosestecker

Der Anschluss für das Diagnose-Software wird unter dem Fahrersattel platziert. Um den Anschluss zu erreichen, müssen der Fahrersitz, wie in den Abschnitt §4.6. der Bedienungsanleitung beschrieben, entfernt werden.

Um die Hardware-Verbindung zu gewährleisten, schließen Sie das entsprechende Schnittstellenkabel (bestellt werden an den MV Agusta-Ersatzteilservice) an den Diagnosestecker.

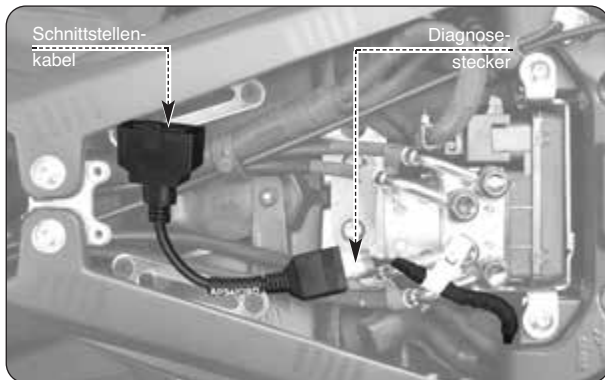



2.2. Störungen am Motor: **DER MOTOR SPRINGT NICHT AN**

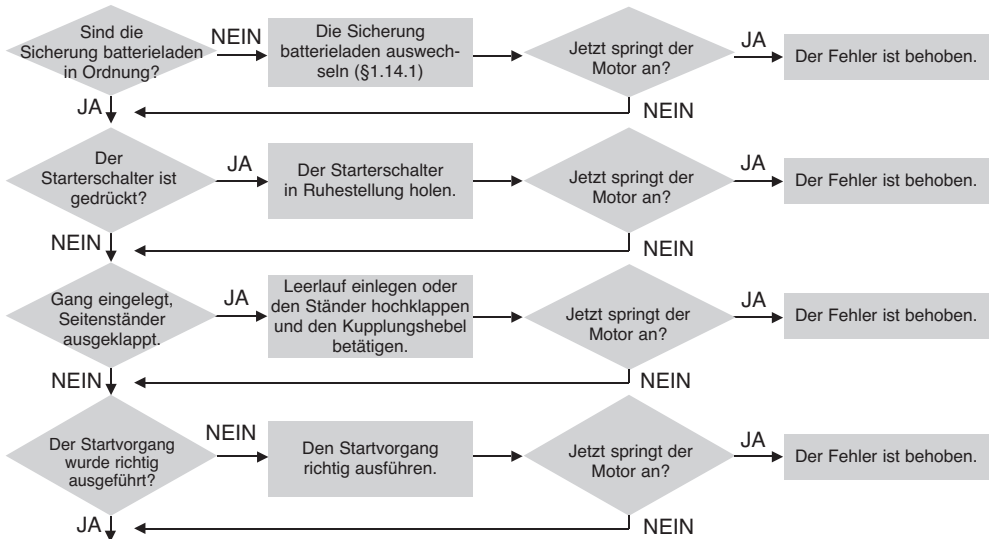

Weiter auf der nächsten Seite



Fortsetzung von der vorherigen Seite

DE 2

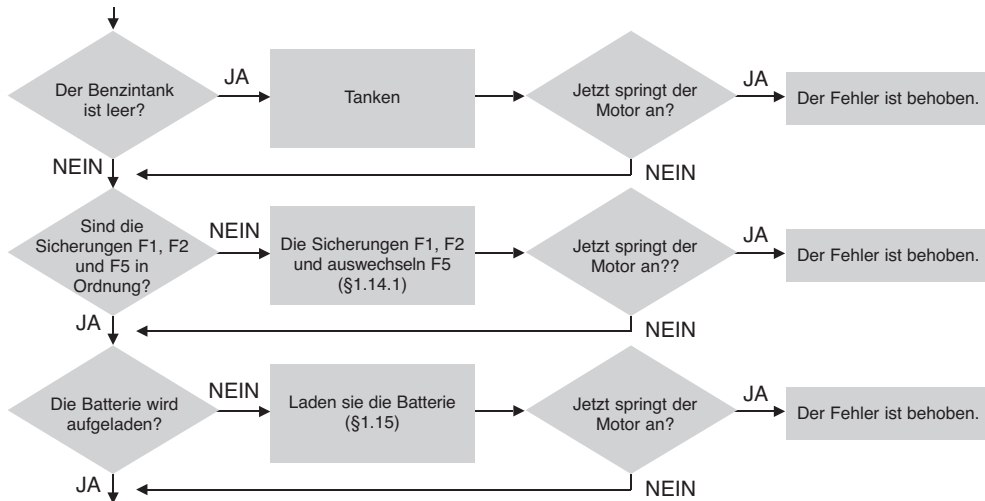

Wenden Sie sich an den
MV Agusta Kundendienst



DER MOTOR STELLT BEIM LAUFEN AB

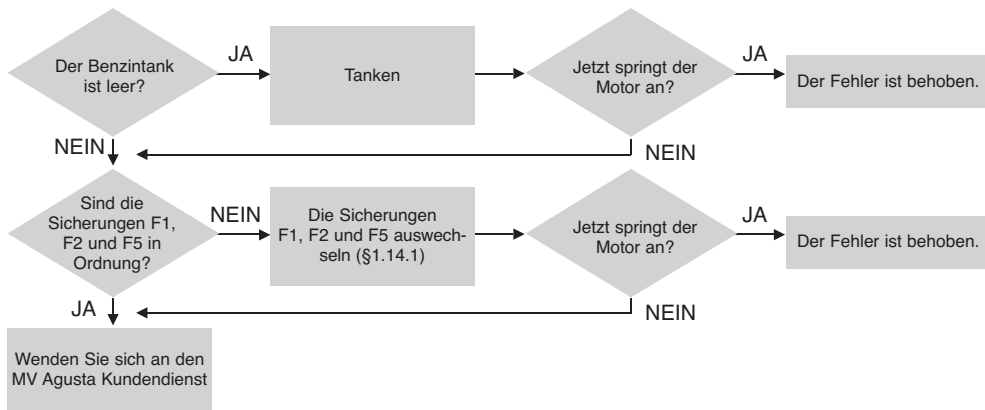



DER MOTOR WIRD ZU HEISS

DE 2

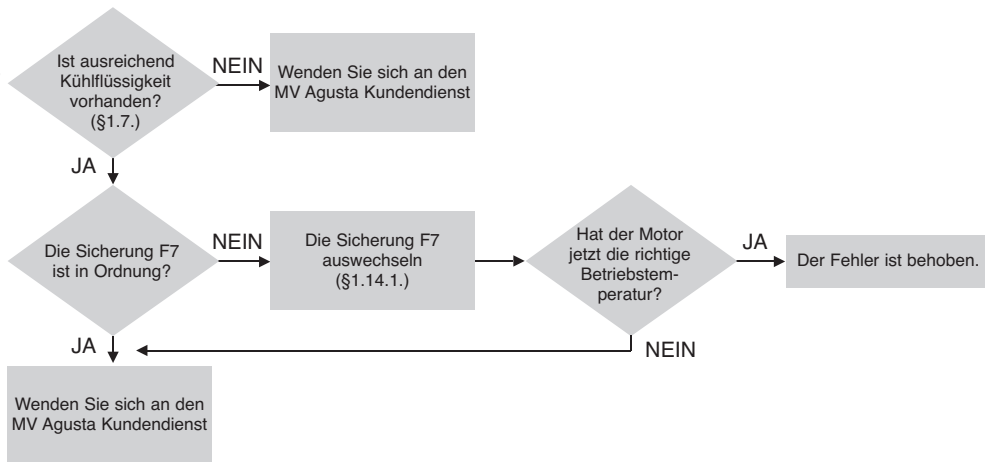



DER ÖLDRUCK IST ZU NIEDRIG (Das Motoröldruck-Kontrolllampe ist eingeschaltet, während der Motor läuft)

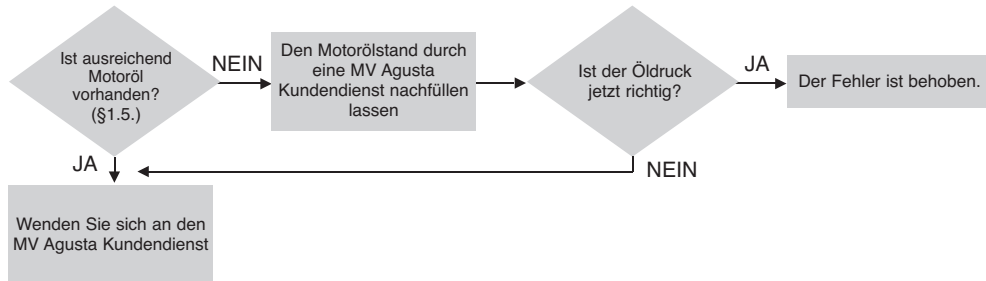



2.3. Störungen an der elektrischen Anlage: **DIE BELEUCHTUNG FUNKTIONIERT NICHT**

DE 2

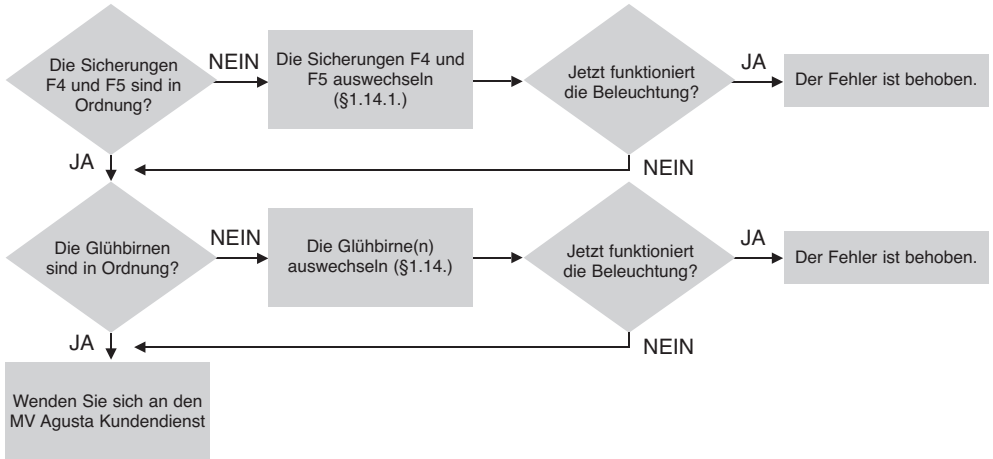



DIE HUPE FUNKTIONIERT NICHT

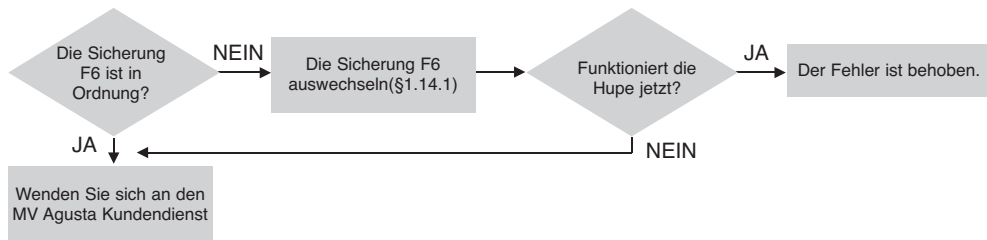

DAS INSTRUMENTENAUSRÜSTUNG FUNKTIONIERT NICHT

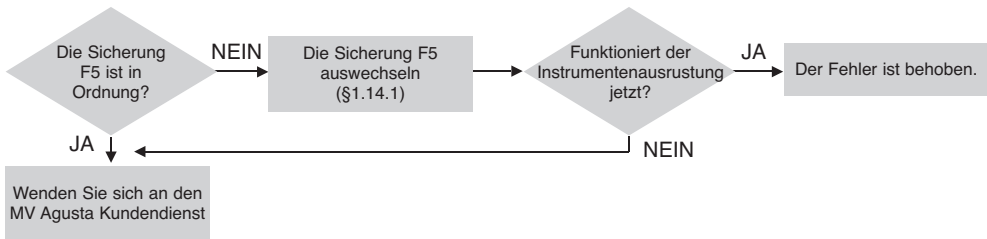



3.1. Allgemeine Beschreibung des Motorrads

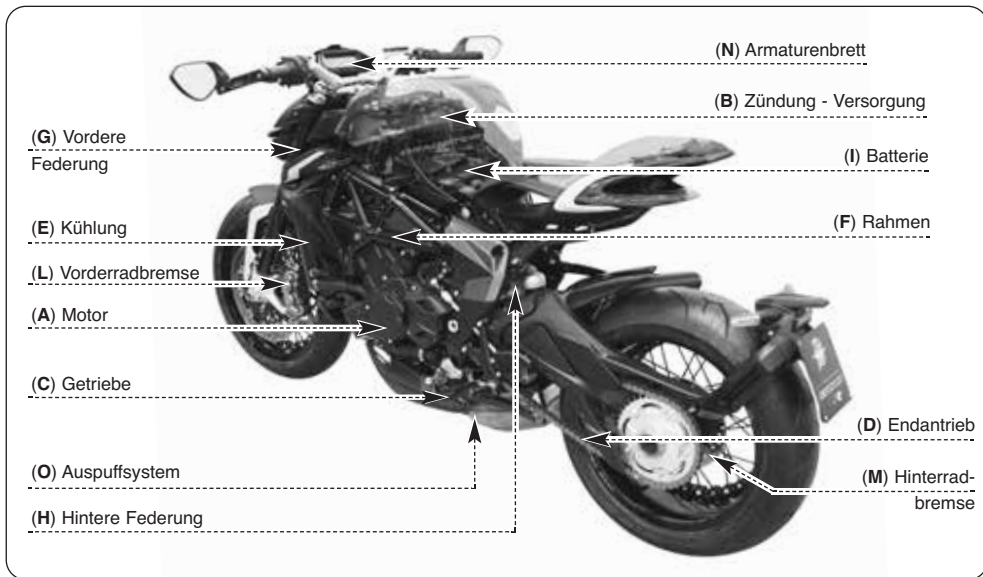



- A - Motor:** Viertaktmotor, drei-Zylinder in Reihe, Ventilsteuerung mit doppelter obenliegender Nockenwelle. Sumpfschmierung.
- B - Zündung - Versorgung:** Integriertes Zünd-Einspritzsystem. Elektronische Zündung mit induktiver Entladung. Elektronische Einspritzung "Multipoint".
- C - Getriebe:** Ausziehbar, Sechsganggetriebe mit ständig greifenden Zahnrädern.
- D - Endantrieb:** Bestehend aus Ritzel, Zahnkranz und Kette.
- E - Kühlung:** mit unterschiedlichen Öl- und Wasser-Wärmetauscher.
- F - Rahmen:** Gitterförmig, Stahlrohrrahmen mit Seitenplatten aus Aluminium.
- G - Vordere Federung:** Hydraulische Gabel mit umgekehrten Gabelschäften. Mit Einstellungssystem.
- H - Hintere Federung:** Schwingarm mit progressiver Wirkung und Einzelstoßdämpfer mit Einstellungssystem.
- I - Batterie:** versiegelt und wartungsfrei.
- L - Vorderradbremse:** Doppelte Bremsscheibe mit halb-schwimmend gelagerten Bremssätteln mit vier Bremskolben.
- M - Hinterradbremse:** Einzelscheibe mit Bremszange mit zwei Bremskolben.
- N - Armaturenbrett:** Ausgestattet mit Kontrolleuchten und digitalen Instrumenten.
- O - Auspuffsystem:** Ausgestattet mit katalytischem Konverter für Abgasverkleinerung.



3.1.1. Bremssystem (ABS)

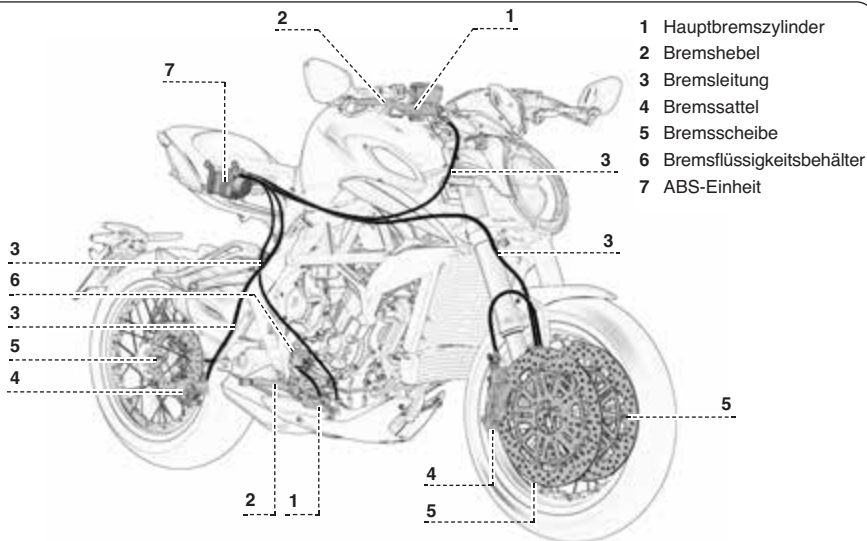



3.1.2. Motorschmierung

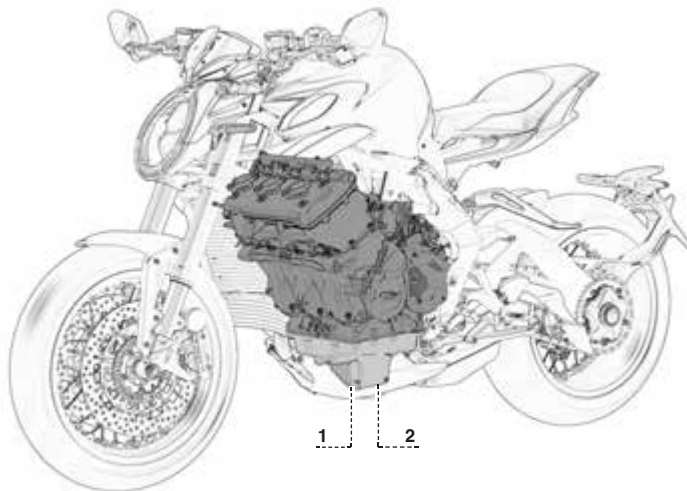

- 1 Ölwanne
- 2 Ölfilter



3.1.3. Kühlkreislauf

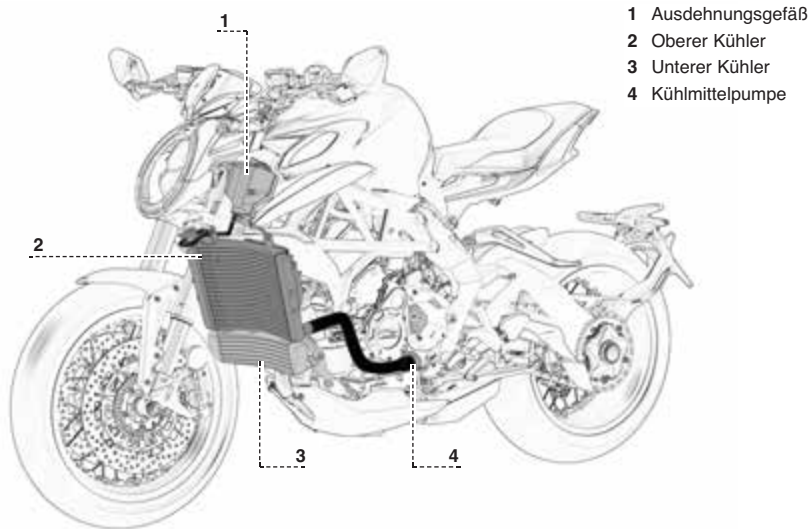



3.1.4. Benzin-Versorgungskreislauf

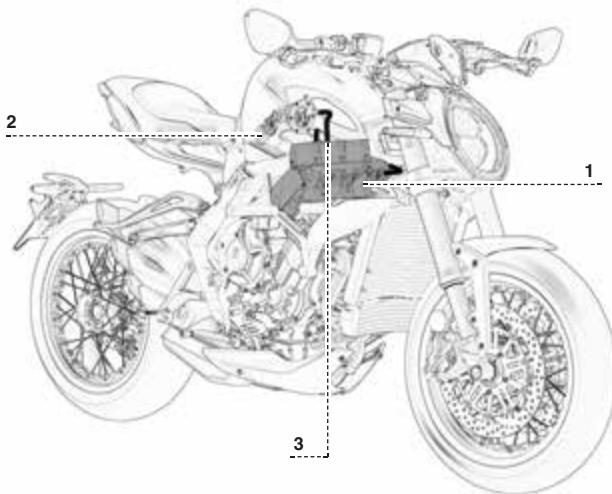

- 1 Drosselkörper
- 2 Benzinpumpe
- 3 Benzinleitung



3.2. Technische Daten

Bezeichnung	Dragster 800 Rosso	Dragster RR / RR SCS	Dragster RC / RC SCS
TECHNISCHE ANGABEN			
Radabstand (mm) (*)	1400	1400	1400
Gesamtlänge (mm) (*)	2035	2035	2035
Gesamtbreite (mm)	935	935	935
Sitzbankhöh (mm) (*)	845	845	845
Bodenfreiheit (mm) (*)	135	135	135
Vorlauf (mm) (*)	103,5	103,5	103,5

* : Die angegebenen Werte sind nicht verbindlich. Die angegebenen Werte können sich je nach Zustand und Trimmung des Fahrzeugs ändern.



Technische Daten

Bezeichnung	Dragster 800 Rosso	Dragster RR / RR SCS	Dragster RC / RC SCS
Leergewicht (kg)	168	168	168
Tankinhalt Benzintank (l) (*)	16,5	16,5	16,5
Benzinreserve (l) (*)	4	4	4
Ölmenge im Motorgehäuse (kg)	2,5	2,5	2,5
MOTOR			
Typ	Dreizylinder-Viertaktmotor, 12 Ventile		
Bohrung (mm)	79,0	79,0	79,0
Hub (mm)	54,3	54,3	54,3
Hubraum (cm ³)	798	798	798
Verdichtungsverhältnis	12,3 : 1	13,3 : 1	13,3 : 1
Umweltstandard	Euro 4	Euro 4	Euro 4
CO ₂ -Emissionen (g/km)	128	163	163
Kraftstoffverbrauch (l/100 km)	5,6	6,7	6,7
Starten/Anlassen	Elektrisch		
Kühlung	Mit unterschiedlichen Öl- und Wasser-Wärmetauscher		
Motorgehäuse und Deckel	Druckguß		
Zylinderkopf und Zylinder	Kokillenguß		
Ventile	Stahl		

* : Die angegebenen Werte sind nicht verbindlich. Die angegebenen Werte können sich je nach Außentemperatur, Motortemperatur und Verdampfungspunkt des verwendeten Benzins ändern.



Technische Daten

Bezeichnung	Dragster 800 Rosso	Dragster RR / RR SCS	Dragster RC / RC SCS
VENTILSTEUERUNG			
Typ	Doppelte obenliegende Nockenwelle		
SCHMIERUNG			
Typ	Sumpfschmierung		
ZÜNDUNG - VERSORGUNG			
Typ	Integriertes Zünd-Einspritzsystem MVICS. Motorsteuer-Einheit Eldor EM2.0; Drosselkörper "full drive by wire" Mikuni; Spulen "pencil-coil" mit Technologie "ion-sensing", Steuerung der Detonation und Misfire. Motordrehmomentkontrolle mit 4 Mappings; Traction Control mit 8 Interventionsebenen.		
Anzahl der Einspritzdüsen	3	6	6
Zündkerzen	NGK CR9 EIB-9	NGK CR9 EIB-9	NGK CR9 EIB-9
Elektrodenabstand (mm)	0.8 ÷ 0.9	0.8 ÷ 0.9	0.8 ÷ 0.9
KUPPLUNG			
Typ	Mehrscheiben-Ölbadkupplung mit hydraulischer Steuerung mit mechanische Anti-Hopfenvorrichtung		
HAUPTANTRIEB			
Zahnzahl Zahnrad Vorgelegewelle	Z = 22	Z = 22	Z = 22
Zahnzahl Zahnrad Kupplung	Z = 41	Z = 41	Z = 41
Übersetzungsverhältnis	1,864	1,864	1,864
ENDANTRIEB			
Zahnzahl Ritzel	Z = 16	Z = 16	Z = 16
Zahnzahl Zahnkranz	Z = 41	Z = 41	Z = 41
Übersetzungsverhältnis	2,563	2,563	2,563



Technische Daten

Bezeichnung	Dragster 800 Rosso	Dragster RR / RR SCS	Dragster RC / RC SCS
GETRIEBE			
Typ	Ausziehbar, Sechsganggetriebe mit ständig greifenden Zahnräder		
Untersetzung Gänge (Gesamtverhältnis)			
Erster	2.846 (13.593)	2.846 (13.593)	2.846 (13.593)
Zweiter	2.187 (10.447)	2.125 (10.149)	2.125 (10.149)
Dritter	1.778 (8.635)	1.778 (8.635)	1.778 (8.635)
Vierter	1.500 (7.165)	1.579 (7.541)	1.579 (7.541)
Fünfter	1.318 (6.295)	1.429 (6.823)	1.429 (6.823)
Sechster	1.190 (5.684)	1.318 (6.295)	1.318 (6.295)
RAHMEN			
Typ	Gitterförmiger ALS-Stahlrohrrahmen (MAG-verschweißt)		
Auflageblech Schwingendrehpunkt	Aluminiumlegierung		
VORDERE FEDERUNG			
Typ	Hydraulische Gabel mit umgekehrten Gabelschäften. Mit Einstellungssystem für Ausdehnungs- und Kompressionsbremse sowie Federvorspannung		
Ø Schaft (mm)	43	43	43
Hubhöhe an Gabelbeinachse (mm)	125	125	125
HINTERE FEDERUNG			
Typ	Progressiv, Einzelstoßdämpfer mit Einstellung für Ausdehnungs- und Kompressionsbremse sowie Federvorspannung		
Einarmschwinge	Aluminiumlegierung		
Radhub (mm)	124	124	124



Technische Daten

Bezeichnung	Dragster 800 Rosso	Dragster RR / RR SCS	Dragster RC / RC SCS
VORDERRADBREMSE			
Typ	Doppelte Bremsscheibe mit halb-schwimmend gelagerten Bremssätteln		
Ø Bremsscheibe (mm)	320		
Bremsscheibenflansch	Stahl		
Bremzange (Durchmesser Bremskolben mm)	Radialbremskolben mit vier Bremskolben (Ø 32)		
HINTERRADBREMSE			
Typ	Stahlscheiben		
Ø Bremsscheibe (mm)	220		
Bremzange (Durchmesser Bremskolben mm)	Zwei Bremskolben (Ø 34)		
VORDERRADFELGE			
Material	Aluminium-legierung	Speichen-Rad - Aluminiumlegierung	Geschmiedete Aluminiumlegierung
Ausmaß	3.50" x 17"	3.50" x 17"	3.50" x 17"
HINTERRADFELGE			
Material	Aluminium-legierung	Speichen-Rad - Aluminiumlegierung	Geschmiedete Aluminiumlegierung
Ausmaß	6.00" x 17"	6.00" x 17"	6.00" x 17"
REIFEN			
Vorne	120/70 ZR 17 M/C (58 W)	120/70 ZR 17 M/C (58 W)	120/70 ZR 17 M/C (58 W)
Hinten	200/50 ZR 17 M/C (75 W)	200/50 ZR 17 M/C (75 W)	200/50 ZR 17 M/C (75 W)



Technische Daten

Bezeichnung	Dragster 800 Rosso	Dragster RR / RR SCS	Dragster RC / RC SCS
Merke und Typ	PIRELLI Diablo Rosso II	PIRELLI Diablo Rosso II	PIRELLI Diablo Rosso II
Reifendruck (*):			
Vorne	2.5 bar (36 psi)	2.5 bar (36 psi)	2.5 bar (36 psi)
Hinten	2.8 bar (41 psi)	2.8 bar (41 psi)	2.8 bar (41 psi)
ELEKTRISCHE ANLAGE			
Spannung	12 V		
Fahrlicht	H11B 12V 55W		
Fernlicht	H3 12V 55W		
Blinkern	LED		
Standlicht hinten	LED		
Bremslicht	LED		
Batterie	12 V - 8,6Ah		
Lichtmaschine	350 W bei 5000 U/min		
KAROSSERIE			
Tank	Thermoplastisches Material		
Seitenteile Tank	Thermoplastisches Material	Thermoplastisches Material	Kohlefaser
Hintere Seitenteile	Thermoplastisches Material		

* : Beim Einsatz anderer Marken als der empfohlenen Reifenmarken muss der vom Reifenhersteller auf der Reifenwand aufgedruckte Reifendruck eingehalten werden.



Technische Daten

Bezeichnung	Dragster 800 Rosso	Dragster RR / RR SCS	Dragster RC / RC SCS
Instrumentenverkleidung	Thermoplastisches Material	Thermoplastisches Material	Kohlefaser
Hinterer Kotflügel	Thermoplastisches Material	Thermoplastisches Material	Kohlefaser
Vorderer Kotflügel	Thermoplastisches Material		
Vordere Kotflügelstützen	Thermoplastisches Material	Thermoplastisches Material	Kohlefaser
Seitenteile Airbox	Thermoplastisches Material		
Ketten-Abdeckung	Thermoplastisches Material		
Nummernschildhalter	Thermoplastisches Material		
Rückspiegel	Thermoplastisches Material		
Abdeckung Auspuffrohr	Aluminium		
Kühlerschutz	Thermoplastisches Material		





DE 3





3.3. Überbau - Farbkennziffer (Dragster 800 Rosso)

Die lackierten Überbauteile die folgende Farbkennziffer haben:

1. - Benzintank:

Rot F4 Ago
(Kennziffer Palinal 926R750)

- 2. - Rechtes zentrale Seitenteil;
- 3. - Linkes zentrale Seitenteil;
- 4. - Vorderes rechtes Seitenteil;
- 5. - Vorderes linkes Seitenteil;
- 6. - Hinteres rechtes Seitenteil;
- 7. - Hinteres linkes Seitenteil:

Schwarz Karbon Metallisiert
(Kennziffer Palinal 928.V311)



DE 3





3.4. Überbau - Farbkennziffer (Dragster RR / RR SCS MY20)

Die lackierten Überbauteile haben im Verhältnis zu der entsprechenden Farbnummer des Motorrads folgende Farbkennziffer:

1. - Benzintank:

- Farb-Code A:

Grau Nacht
(Kennziffer Lechler LCH29902-662) +
Schwarz Karbon Metallisiert
(Kennziffer Palinal 928.V311)

- Farb-Code B:

Weiß Perlige ICE
(Kennziffer Lechler 2902181) +
Schwarz Karbon Metallisiert
(Kennziffer Palinal 928.V311)

2. - Rechtes zentrale Seitenteil;

3. - Linkes zentrale Seitenteil:

Schwarz Karbon Metallisiert
(Kennziffer Palinal 928.V311)

4. - Vorderes rechtes Seitenteil;

5. - Vorderes linkes Seitenteil;

6. - Hinteres rechtes Seitenteil;

7. - Hinteres linkes Seitenteil:

- Farb-Code A:

Gelb Perlige Metallisiert
(Kennziffer Lechler LCC00997 +
Lechler LCC00998)

- Farb-Code B:

Neongrün
(Kennziffer Lechler BDCR216)



DE 3





3.5. Überbau - Farbkennziffer (Dragster RC / RC SCS MY20)

Die lackierten Überbauteile die folgende Farbkennziffer haben:

1. - **Benzintank;**
2. - **Vorderes rechtes Seitenteil;**
3. - **Vorderes linkes Seitenteil:**

Gris Avio Metallisiert
(Kennziffer Palinal 928.T892) +
Schwarz Karbon Metallisiert
(Kennziffer Palinal 928.V311)

4. - **Vordere Kotflügel;**
5. - **Rechtes Airbox-Seitenteil;**
6. - **Linkes Airbox-Seitenteil;**
7. - **Hinteres rechtes Seitenteil;**
8. - **Hinteres linkes Seitenteil:**

Schwarz Karbon Metallisiert
(Kennziffer Palinal 928.T892)



DE 3

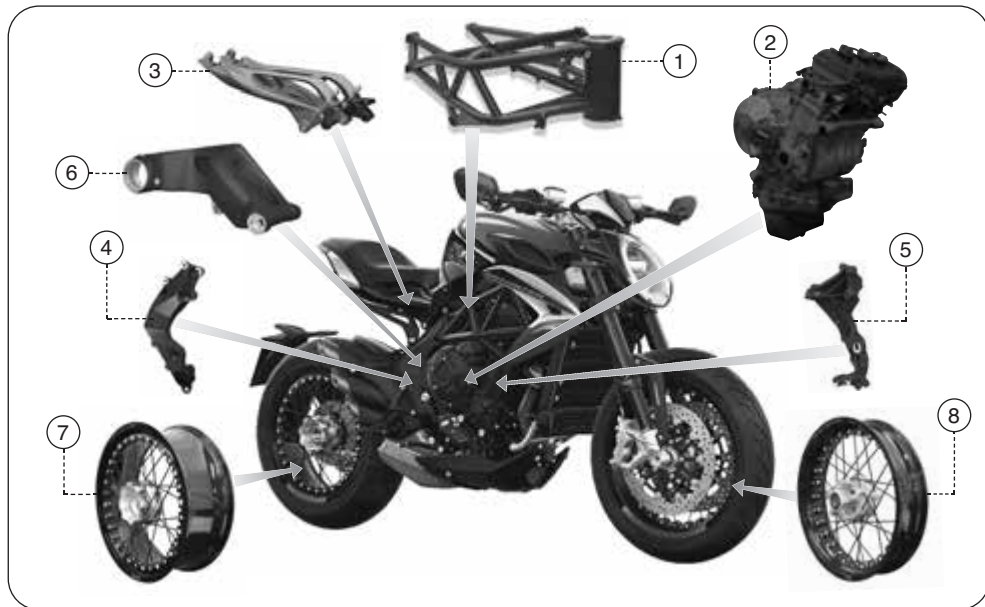



3.6. Rahmen- und Radfahrteile Farbkennziffer

Die lackierten Rahmen- u. Radfahrteile die folgende Farbkennziffer haben:

1. - Rahmen:

- **Dragster 800 / RR / RR SCS MY20:**
Schwarz Glänzend
(Kennziffer PPG PCU 90207)
- **Dragster RC / RC SCS MY20:**
Rot Rahmen
(Kennziffer Akzo Nobel QG000K Red)

3. - Heckrahmen;

4. - Rechte Gabeldrehbolzenplatte;

5. - Linke Gabeldrehbolzenplatte;

6. - Hintergabel:

Schwarz Quasar (Kennziffer Inver 61196 -
Poliest/HD TGIC Free)

2. - Motor:

Schwarz Matt
(Kennziffer Pulverit 3500/0085)

7. - Hinterradfelge;

8. - Vorderradfelge:

- **Dragster 800 Rosso:** Schwarz Glänzend
(Kennziffer Peter Lacke VPCH03250)
- **Dragster RR / RR SCS MY20:**
Schwarz Glänzend
- **Dragster RC / RC SCS MY20:**
Rot Glänzend (Kennziffer Da Qiao
WFMY-S09-Q + WFMY-S10-Q)



Informationshinweis

MV Agusta Motor S.p.A. verfolgt eine Politik ständiger Verbesserung ihrer Produkte. Aus diesem Grund kann es vorkommen, dass kleine Abweichungen zwischen dem vorliegenden Dokument und dem von Ihnen erworbenen Fahrzeug bestehen. Die Modelle MV Agusta werden in zahlreiche Länder exportiert, in denen unterschiedliche Straßenverkehrsordnungen und Zulassungsverfahren bestehen. In der Hoffnung auf Ihr Verständnis behält sich MV Agusta Motor S.p.A. deshalb das Recht vor, jederzeit und ohne Vorankündigung, Änderungen an ihren Produkten und den technischen Dokumentationen vorzunehmen.

Wir schlagen vor, um den Internetplatz **www.mvagusta.com** häufig zu besichtigen, um Informationen und Updates über die MV Agusta-Produkte und die in Verbindung stehenden Unterlagen zu erhalten.



Die Umwelt schützen und respektieren

Alles was wir tun hat Auswirkungen auf den gesamten Planeten und seine Ressourcen. Zum Schutz der Gemeinschaft weist MV Agusta die Kunden und die Angestellten im Kundendienst darauf hin, wie das Motorrad umweltschonend genutzt und Motorradbauteile und Flüssigkeiten entsprechend der geltenden Umweltschutzgesetze entsorgt bzw. dem Recycling zugeführt werden können.

© 2020

Die vollständige oder teilweise Vervielfältigung dieses Dokuments ist ohne vorherige schriftliche Genehmigung der MV Agusta Motor S.p.A.

Teilnr. n° 8000C8714

Ausgabe n° 1 - Januar 2020

MV AGUSTA

**DRAGSTER
EIGHTHOUR**



Manual de mantenimiento
Versión en Español



INDICE GENERAL

Cap.	Descripción temas	pág.
1	MANTENIMIENTO	3
1.1.	Símbolos	3
1.2.	Tablas de mantenimiento y control	4
1.3.	Utillaje y accesorios del equipamiento base	14
1.4.	Tabla de lubricantes y líquidos	15
1.5.	Aceite motor - Control nivel	16
1.5.1.	Aceite motor - Reposición nivel	17
1.6.	Líquido refrigerante - Control nivel	19
1.6.1.	Líquido refrigerante - Reposición nivel	20
1.7.	Pastillas frenos - Control desgaste	22
1.8.	Fluido mando frenos - Control nivel	23
1.9.	Fluido mando embrague - Control nivel	25
1.10.	Neumáticos - Control y cambio	26
1.11.	Cadena - Control y lubricación	32
1.12.	Ralentí - Control	36
1.13.	Sistema de control de las emisiones de evaporación	37
1.14.	Sustituciones - Información general	38
1.14.1.	Fusibles - Sustitución	38
1.14.2.	Luz de cruce - Sustitución bombilla	42
1.14.3.	Luz de carretera - Sustitución bombilla	44
1.15.	Batería	45

Cap.	Descripción temas	pág.
1.16.	Limpieza de la motocicleta	47
1.17.	Periodo de larga inactividad	49
2	AVERÍAS	50
2.1.	Posición del conector de diagnóstico	50
2.2.	Inconvenientes en el motor	51
2.3.	Inconvenientes en la instalación eléctrica	56
3	INFORMACIÓN TÉCNICA	58
3.1.	Descripción general de la motocicleta	58
3.1.1.	Sistema de frenado (ABS)	60
3.1.2.	Lubricación motor	61
3.1.3.	Circuito de refrigeración	62
3.1.4.	Circuito de alimentación	63
3.2.	Datos técnicos	64
3.3.	Referencias de los colores de las superestructuras (Dragster 800 Rosso)	72
3.4.	Referencias de los colores de las superestructuras (Dragster RR / RR SCS MY20)	74
3.5.	Referencias de los colores de las superestructuras (Dragster RC / RC SCS MY20)	76
3.6.	Referencias colores componentes del bastidor y parte ciclística	78



1.1. Símbolos

Las partes del texto de particular importancia, correspondientes a la seguridad de la persona y a la integridad de la motocicleta, están evidenciadas con los siguientes símbolos:



Peligro - Atención: la falta o el incompleto cumplimiento de estas prescripciones puede comportar un grave peligro para su incolumidad o para la de otras personas.



Prudencia - Precaución: la falta o el incompleto cumplimiento de estas prescripciones puede comportar un riesgo de daños a la motocicleta.

Para indicar las personas autorizadas al desarrollo de las operaciones de ajustes y/o mantenimiento, las mismas se encuentran marcadas con los símbolos siguientes:



Información de las operaciones permitidas al motociclista.



Información de las operaciones que deben ser llevadas a cabo sólo por personal autorizado.

Para poner en evidencia ulteriores informaciones se utilizan los siguientes símbolos:



El símbolo  indica que es necesario utilizar una herramienta o utillaje específico para realizar correctamente la operación descrita.



El símbolo “§” indica que nos remitimos al capítulo indicado por el número que lo sigue.



1.2. Tablas de mantenimiento y control

Las operaciones de mantenimiento y control más importantes y su frecuencia están indicadas en las tablas específicas. Es indispensable efectuar éstas operaciones para, mantener la motocicleta eficiente y segura.

Los intervalos indicados en la tabla de la manutención periódica y de lubricación se deben considerar solo como una guía general en normales condiciones de marcha. Podría ser necesario reducir tales intervalos en función a las condiciones climáticas, del terreno, de la situación geográfica y del uso individual.

Algunas operaciones las puede efectuar el propietario de la motocicleta siempre que posea los conocimientos necesarios. En caso contrario haga efectuar las operaciones en un centro de asistencia autorizado.

En general las operaciones de mantenimiento se efectúan con la motocicleta colocada sobre el caballete trasero, con motor apagado y con interruptor en posición "OFF". Durante la verificación de los niveles de los líquidos en cambio es preferible tener la moto en posición vertical sin utilizar el caballete trasero.

Superados los 105.000 Km (63000 mi), las operaciones se deben efectuar con la frecuencia indicada en las correspondientes tablas.



PELIGRO

- Una **manutención no correcta o la falta de realización de trabajos de manutención aconsejados, aumenta el riesgo de accidentes o de daños a la moto.**
- **Utilizar siempre recambios originales MV Agusta. El uso de recambios no originales puede acelerar el desgaste de la moto y reducir la durabilidad.**
- **La falta de realización de las operaciones recomendadas o la utilización de recambios no originales podía hacer la garantía ser inválida.**
- **El cambio y/o el restablecimiento del nivel de los lubricantes se debe realizar exclusivamente con los productos indicados en el §1.4.**



ATENCIÓN

En caso de utilizar la motocicleta en pistas, se recomienda hacerla controlar por personal especializado perteneciente a la red de Centros de Asistencia MV Agusta antes y después del uso.

La conducción en pista sólo está permitida en casos ocasionales y, de todas formas, sin fines agonísticos, aunque sea en calidad de aficionados.

El uso de la moto en pista comporta un significativo aumento del consumo de varios componentes, con una menor duración de los mismos respecto del uso normal en carreteras y autopistas.



Tabla de mantenimiento programado

(*): Los cupones de kilometraje se pueden llevar junto con el cupón anual **obligatorio**

Frecuencia Manutención Km (mi) *			0	1000 (600)	Cada año	15000 (9000)	30000 (18000)	45000 (27000)	60000 (36000)	75000 (45000)	90000 (54000)	105000 (63000)
Cupón			En- trega	A	B	C	D	E	F	G	H	
DESCRIPCIÓN		OPERACIÓN										
Centralita motor		Control mapeado	•	•	•	•	•	•	•	•	•	•
Aceite motor		Control/Restablecimiento nivel	Antes de usar el vehículo									
		Control/Restablecimiento nivel	•									
		Sustitución	•	•	•	•	•	•	•	•	•	•
Filtro aceite motor		Sustitución (Utilizar únicamente filtros de aceite originales MV Agusta)	A cada sustitución del aceite motor									
Líquido de refrigeración		Control/Restablecimiento nivel	Antes de usar el vehículo									
		Control/Restablecimiento nivel	•	•	•	•	•	•	•	•	•	•
		Sustitución	Cada dos años									
Instalación de refrigeración		Control pérdidas	•	•	•	•	•	•	•	•	•	•
Electroventilador		Control funcionamiento	•	•	•	•	•	•	•	•	•	•
Válvulas		Control / Regulación				•		•		•		
Cadena distribución		Sustitución										•



Tabla de mantenimiento programado

(*): Los cupones de kilometraje se pueden llevar junto con el cupón anual **obligatorio**

Frecuencia Manutención Km (mi) *		0	1000 (600)	Cada año	15000 (9000)	30000 (18000)	45000 (27000)	60000 (36000)	75000 (45000)	90000 (54000)	105000 (63000)
Cupón		En- trega	A	B	C	D	E	F	G	H	
DESCRIPCIÓN		OPERACIÓN									
Patín fijo distribución		Sustitución									●
Patín móvil distribución		Sustitución									●
Tensor cadena distribución		Sustitución									●
Bujías		Sustitución				●		●		●	
Filtro gasolina		Sustitución				●		●		●	
Cuerpo mariposa		Control / limpieza conductos				●		●		●	
		Control sensor de presión				●		●		●	
Filtro aire (Reducir los intervalos cuando se conduce en áreas altamente contaminadas)		Control / Sustitución			●		●		●		●
		Sustitución				●		●		●	
Cilindros		Control compresión				●		●		●	
Fluido frenos y embrague		Control nivel	Antes de usar el vehículo								
		Control nivel	●	●	●	●	●	●	●	●	●
		Sustitución	Cada dos años								



Tabla de mantenimiento programado

(*): Los cupones de kilometraje se pueden llevar junto con el cupón anual **obligatorio**

Frecuencia Manutención Km (mi) *		0	1000 (600)	Cada año	15000 (9000)	30000 (18000)	45000 (27000)	60000 (36000)	75000 (45000)	90000 (54000)	105000 (63000)
Cupón		En- trega	A	B	C	D	E	F	G	H	
DESCRIPCIÓN	OPERACIÓN										
Frenos/Embrague	Control funcionalidad	Antes de usar el vehículo									
	Control funcionalidad y circuito	•	•	•	•	•	•	•	•	•	•
	Limpieza área de contacto palanca/piston bomba freno		•	•	•	•	•	•	•	•	•
Acoplamiento flexible embrague	Control / Sustitución										•
	Control desgaste	Cada 1000 km (600 mi)									
Pastillas frenos (delantero + trasero)	Control / Sustitución	•		•	•	•	•	•	•	•	•
	Control defectos y pérdidas		•	•	•	•	•	•	•	•	•
Tubería circuito carburante	Sustitución	De cualquier manera cada 3 años									
	Control funcionalidad	Antes de usar el vehículo									
Mando acelerador	Control funcionalidad (con diagnóstico TEXA)	•	•	•	•	•	•	•	•	•	•
Acoplamiento flexible corona	Control			•							
	Control / apriete tuerca		•	•							
	Sustitución				•	•	•	•	•	•	•



Tabla de mantenimiento programado

(*): Los cupones de kilometraje se pueden llevar junto con el cupón anual **obligatorio**













Frecuencia Manutención Km (mi) *		0	1000 (600)	Cada año	15000 (9000)	30000 (18000)	45000 (27000)	60000 (36000)	75000 (45000)	90000 (54000)	105000 (63000)
Cupón		En- trega	A		B	C	D	E	F	G	H
DESCRIPCIÓN		OPERACIÓN									
Cadena de transmisión 		Control									
		Cada 1000 Km (600 mi)									
		Lubrificación									
		Cada 1000 km (600 mi) y después de conducción con lluvia									
		●	●	●	De cualquier manera cada 1000 Km (600 mi)						
		Lubrificación									
		De cualquier manera cada 1000 Km (600 mi)									
Piñón / Arandela de fijación			●	●							
					●	●	●	●	●	●	●
Corona			●	●							
					●	●	●	●	●	●	●
Neumáticos		Control presión									
		Cada vez que se utiliza el vehículo y de todas maneras cada 10 días									
		Control desgaste									
		Cada vez que se utiliza el vehículo y de todas maneras cada 500 Km (300 mi)									
		●	●	●	●	●	●	●	●	●	●
			●	●	●	●	●	●	●	●	●



Tabla de mantenimiento programado

(*): Los cupones de kilometraje se pueden llevar junto con el cupón anual **obligatorio**















Frecuencia Manutención Km (mi) *		0	1000 (600)	Cada año	15000 (9000)	30000 (18000)	45000 (27000)	60000 (36000)	75000 (45000)	90000 (54000)	105000 (63000)
Cupón		En- trega	A	B	C	D	E	F	G	H	
DESCRIPCIÓN	OPERACIÓN										
Cojinetes dirección 	 Control / Regulación		•		•		•		•		•
	 Lubricación					•		•		•	
Llantas rueda	 Control visivo	•	•	•	•	•	•	•	•	•	•
De cualquier manera a cada cambio de neumáticos											
Radios de las ruedas (Dragster RR-SCS)	 Verificación / Apriete		•	•	•	•	•	•	•	•	•
Cada año											
Cojinetes rueda delantera 	 Control				•	•	•		•	•	•
	 Sustitución							•			
Caballete lateral	 Control funcionalidad	Antes de usar el vehículo									
	 Control funcionalidad	•	•	•	•	•	•	•	•	•	•
Interruptor caballete lateral	 Control funcionalidad	Antes de usar el vehículo									
	 Control funcionalidad	•	•	•	•	•	•	•	•	•	•
Cojinetes horquilla 	 Control / Lubricación							•			



Tabla de mantenimiento programado

(*): Los cupones de kilometraje se pueden llevar junto con el cupón anual **obligatorio**

Frecuencia Manutención Km (mi) *			0	1000 (600)	Cada año	15000 (9000)	30000 (18000)	45000 (27000)	60000 (36000)	75000 (45000)	90000 (54000)	105000 (63000)
Cupón			En- trega	A	B	C	D	E	F	G	H	
DESCRIPCIÓN		OPERACIÓN										
Buje rueda trasera		Control / Lubricación cojinetes de rodillo			•	•		•	•		•	
		Sustitución					•			•		
Patines cadena horquilla		Control / Sustitución			•	•	•	•	•	•	•	
Patines cadena placa bastidor		Control / Sustitución			•	•	•	•	•	•	•	
Amortiguador trasero		Control / Regulación		•	•	•	•	•	•	•	•	
Horquillas delanteras		Control / Regulación		•	•	•	•	•	•	•	•	
		Sustitución aceite					•		•		•	
Sistema de control de las emisiones de evaporación		Control / Sustitución tubos, racores y canister					•	•	•	•	•	
		Control / Limpieza entrada del aire caliente en el canister					•	•	•	•	•	
Conexiones batería		Control y limpieza				•	•	•	•	•	•	
Electrical equipment		Control funcionalidad	•	•	•	•	•	•	•	•	•	
Instalación eléctrica		Control funcionalidad	Antes de usar el vehículo									
		Control funcionalidad	•	•	•	•	•	•	•	•	•	•



Tabla de mantenimiento programado

(*): Los cupones de kilometraje se pueden llevar junto con el cupón anual **obligatorio**

Frecuencia Manutención Km (mi) *		0	1000 (600)	Cada año	15000 (9000)	30000 (18000)	45000 (27000)	60000 (36000)	75000 (45000)	90000 (54000)	105000 (63000)
Cupón		En- trega	A		B	C	D	E	F	G	H
DESCRIPCIÓN		OPERACIÓN									
Luces / Señales visivas		Control funcionalidad									
		Antes de usar el vehículo									
Claxon		Control funcionalidad									
		•	•	•	•	•	•	•	•	•	•
Faro delantero		Control funcionalidad									
		Regulación									
Interruptor encendido		Control funcionalidad									
		•	•	•	•	•	•	•	•	•	•
Cerraduras		Control funcionalidad									
		•	•	•	•	•	•	•	•	•	•
Tornillos y tuercas		•	•	•	•	•	•	•	•	•	•
Abrazaderas		•	•	•	•	•	•	•	•	•	•
Lubricación general		•	•	•	•	•	•	•	•	•	•
Prueba motocicleta		•	•	•	•	•	•	•	•	•	•



Tabla de mantenimiento programado

(**): Los cupones de kilometraje en el embrague Dragster SCS no están subordinados al cupón anual **obligatorio**

Frecuencia Manutención Km (mi) **		0	1000 (600)	Cada año	15000 (9000)	30000 (18000)	45000 (27000)	60000 (36000)	75000 (45000)	90000 (54000)	105000 (63000)
Cupón		En- trega	A		B	C	D	E	F	G	H
DESCRIPCIÓN	OPERACIÓN										
Freno de estacionamiento (Dragster SCS)	Control funcionalidad	Antes de usar el vehículo									
Embrague automático (Dragster SCS)	Control / Regulación juego	•	•	•	•	•	•	•	•	•	•
Discos embrague con junta (Dragster SCS) **	Sustitución				•	•	•	•	•	•	•
Disco expansór embrague (Dragster SCS) **	Control / Remontaje a la inversa				•		•		•		•
	Sustitución					•		•		•	



ES
1

1.3. Utillaje y accesorios del equipamiento base

Bajo el sillín del pasajero se pueden encontrar las siguientes herramientas:

- n. 2 llaves macho hexagonal (hexágono de 2,5 mm - 4 mm);
- n. 1 llave para excéntrico rueda trasera y correspondiente prolongación;
- n. 1 extractor para fusibles;

Dentro de la caja de fusibles también se pueden encontrar los siguientes fusibles de repuesto (ver §1.12.1):

- 1 fusible (10A);
- 2 fusibles (15A);
- 1 fusible (25A).





1.4. Tabla lubricantes y líquidos

Descripción	Producto aconsejado	Características
Aceite lubricación motor	Motul 7100 4T 5W40 (*)	SAE 5W40
Líquido de refrigeración	Motul Motocool Factory Line	Producto basado en monoetilenglicol - Listo para usar - No añadir agua
Fluido mando embrague y frenos	Motul DOT 3 & 4 Brake Fluid	DOT4
Aceite lubricación cadena	Motul Chain Lube Road	-

* : Para encontrar fácilmente los productos recomendados, MV Agusta aconseja dirigirse directamente a los propios concesionarios autorizados. El motor de la motocicleta Dragster ha sido desarrollado con el aceite para motor Motul 7100 4T 5W40. En el caso que el lubricante descrito no se consiga, MV Agusta aconseja utilizar aceites completamente sintéticos con características conformes o superiores a las siguientes normas:

- Conforme API SN / SM
- Conforme JASO MA2
- Gradación SAE 5W40

NOTA

Las especificaciones indicadas deben estar presentes, por sí solas o junto a otras, en el envase del aceite lubricante.





1.5. Aceite motor - Control nivel

Efectúe el control en frío, con motor apagado. Si se efectúa en caliente, apague el motor y espere por lo menos 10 minutos.

Este control se debe realizar colocando la motocicleta en un plano horizontal y en posición de la marcha (posición vertical).

 **CUIDAD: Esta operación se debe realizar por dos personas.**

Desenroscar el tapón de llenado de aceite y sacarlo de su asiento. Limpiar la barra de control con un paño limpio y apretar el tapón de llenado de aceite en su asiento, luego desenroscarlo para comprobar el nivel de aceite del motor.

El nivel tiene que estar comprendido entre las referencias MAX y MIN indicadas en barra de control de el nivel de aceite conectada a el tapón.

En el caso que el nivel del aceite se encuentre por debajo de la referencia MIN, añadir (ver § 1.5.1).

 **Peligro - Atención: No arranque el motor si el aceite está por debajo de la referencia de MIN.**

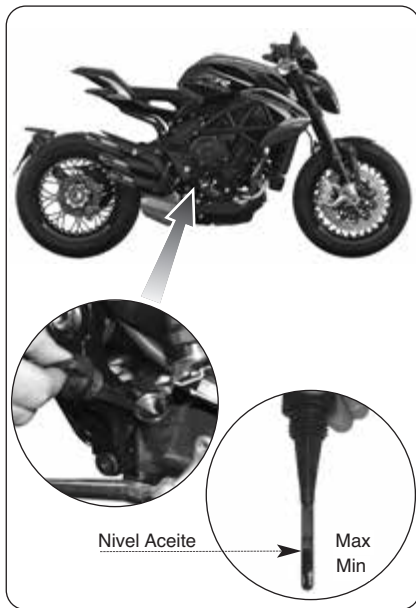



1.5.1. Aceite motor - Reposición nivel

Desenroscar el tapón de aceite. Echar una cantidad de aceite del tipo recomendado hasta alcanzar el nivel correcto; de cualquier manera no superar nunca la marca MAX. Enroscar nuevamente la tapa una vez terminada la operación.



PRUDENCIA - PRECAUCIÓN

Para evitar deslizamientos del embrague y consiguiente daño del motor, no mezclar aditivos químicos al aceite, ni utilizar aceites distintos del tipo indicado en el § 1.4. Asegurarse que no se introduzcan cuerpos extraños en el cárter durante el llenado.





PELIGRO

El aceite nuevo o exhausto puede ser peligroso. La ingestión del aceite del motor, nuevo o exhausto puede ser nocivo para las personas y para los animales domésticos. En caso de ingestión del aceite del motor, llamar inmediatamente un médico y no provocar vómito para evitar la aspiración del producto en los pulmones. Ha sido constatado que el contacto continuado con el aceite produce cáncer en la piel en ratones para experimentación. Breves contactos con el aceite del motor pueden producir irritación de la piel.

- Tener el aceite del motor, nuevo o exhausto lejos del alcance de los niños y de animales domésticos.
- Ponerse ropa con mangas largas y guantes impermeables al agua cada vez que se efectúa el llenado del aceite del motor.
- Lavarse con agua y jabón, si el aceite del motor entra en contacto con la piel.
- Reciclar o eliminar correctamente el aceite motor exhausto.



1.6. Líquido refrigerante - Control nivel

Efectúe el control en frío, con el motor apagado. Este control se debe efectuar colocando la motocicleta en un plano horizontal y en posición de marcha (posición vertical).

El nivel tiene que estar ligeramente por encima la referencia de MIN, según lo demostrado en la figura.

En el caso que el nivel del líquido refrigerante se encuentre por debajo de la marca MIN, añadir (ver § 1.6.1).



PELIGRO

No utilizar la motocicleta si el nivel del líquido refrigerante se encuentra por debajo de la marca MIN.

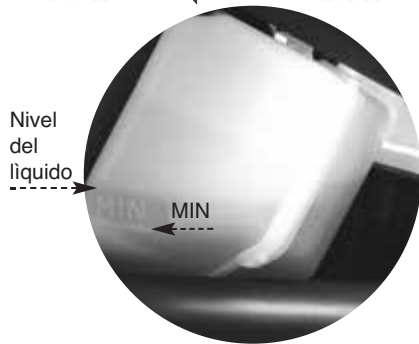



1.6.1. Líquido refrigerante - Reposición nivel

Desenroscar y quitar la tapa del tanque de expansión. Con una jeringa, llenar con líquido refrigerante aconsejado en el § 1.4.



PELIGRO

El depósito se debe llenar con el motor frío. No intentar nunca quitar la tapa del depósito del líquido refrigerante cuando el motor está caliente para evitar quemaduras. El circuito se encuentra bajo presión.

Después de la reposición del nivel, vuelva a montar cuidadosamente las piezas anteriormente desmontadas.





PELIGRO:

En determinadas condiciones el glicol etílico contenido en el líquido refrigerante es inflamable y la llama es invisible. Evitar que el líquido refrigerante vaya a contacto con partes calientes, puesto que con la combustión del glicol etílico podría haber peligro de quemaduras.



PELIGRO:

El líquido refrigerante del motor es nocivo si es ingerido o a contacto con los ojos y la piel. Tener el líquido refrigerante del motor lejos del alcance de los niños y de los animales domésticos. En caso de ingestión del líquido refrigerante llamar inmediatamente un médico y no provocar vómito para evitar aspiraciones del producto en los pulmones. En caso de contacto del líquido refrigerante del motor con los ojos o la piel, lavar inmediatamente con agua.



PRUDENCIA - PRECAUCIÓN:

Para restablecer el nivel del líquido refrigerante y/o substituir el líquido refrigerante, usar exclusivamente el producto específico de la tabla § 1.4. No mezcle ni no diluya el líquido refrigerante con aditivos o diversos líquidos. Si el líquido refrigerante especificado en la tabla § 1.4. no está disponible, utilice un líquido refrigerante con características técnicas conformes al producto prescrito.



PRUDENCIA - PRECAUCIÓN:

Las salpicaduras del líquido refrigerante pueden dañar las superficies pintadas. Tener cuidado en no derramar el líquido cuando llenamos el circuito de refrigeración. Secar inmediatamente con un trapo limpio el líquido derramado.



ES 1

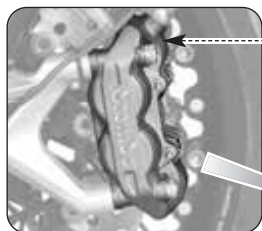

Pinza freno delantero



Pinza freno trasero

Disco freno

Pastillas

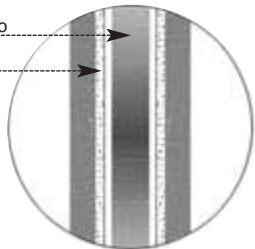

Límite de desgaste 1 mm

1.7. Pastillas frenos - Control desgaste

Verificar periódicamente el espesor de la capa del material de la fricción de las pastillas, teniendo cuidado en no superar el límite de desgaste (1 mm).



Peligro - Atención: Si se utiliza la moto con las pastillas de frenos desgastadas, la fuerza de la frenada disminuye y aumenta el riesgo de accidentes. Si el espesor residuo está cerca del límite de desgaste, dirigirse a un centro de asistencia autorizado para cambiar las pastillas. Someter las pastillas nuevas a un oportuno rodaje.



Depósito freno trasero

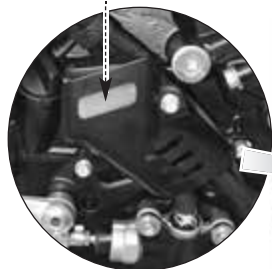

Depósito freno delantero



1.8. Fluido mando frenos - Control nivel



PELIGRO

La falta de control y una manutención incorrecta de los frenos aumenta el riesgo de accidentes. Antes de salir con la moto, controlar el sistema de frenos según las instrucciones indicadas a lado.

El desgaste de las pastillas de los frenos provoca una normal disminución del nivel del fluido. De cualquier manera el nivel debe estar comprendido entre las marcas MAX y MIN. Si tal nivel desciende por debajo de la referencia MIN, es necesario dirigirse a un centro de asistencia autorizado para un control general de la instalación de frenado.

**PELIGRO**

No usar la motocicleta si el nivel se encuentra por debajo de la marca MIN; en tales condiciones el circuito de frenos podría funcionar no correctamente provocando la pérdida del control del vehículo y accidentes. Si el nivel del líquido se encuentra por debajo de la marca MIN, dirigirse a un concesionario MV Agusta para efectuar la comprobación del sistema de frenos.

**PELIGRO**

Hacer añadir líquido de frenos exclusivamente por personas autorizadas. El líquido de frenos es nocivo o mortal si es ingerido, y es nocivo a contacto con la piel y los ojos. Tener el líquido lejos del alcance de los niños y de animales domésticos. En el caso de ingestión del líquido de frenos llamar inmediatamente un médico y no provocar vómito para evitar aspiraciones en los pulmones. En el caso de contacto del líquido con los ojos o con la piel, lavarse inmediatamente con agua.

**PELIGRO**

Hacer añadir líquido de frenos utilizando exclusivamente el tipo de líquido recomendado en el § 1.4. de éste manual. Eventuales mezclas con tipos diferentes pueden provocar una reacción química peligrosa y la disminución de la eficiencia de la frenada, con consiguiente aumento del riesgo de accidentes.

**PELIGRO**

Una cantidad insuficiente del líquido de frenos puede permitir la entrada de aire en el circuito de frenos, perjudicando la eficiencia de la frenada con consiguiente aumento del riesgo de accidentes. La presencia de aire en el circuito hidráulico se podría notar en el caso que apretando la palanca del freno, se advirtiera poca resistencia. En el caso que haya aire en el circuito hidráulico, realizar el expurgo en un concesionario MV Agusta antes de utilizar el vehículo.



1.9. Fluido mando embrague - Control nivel

El nivel tiene que estar comprendido entre las referencias MAX y MIN. Si tal nivel desciende por debajo de la referencia MIN, es necesario dirigirse a un centro de asistencia autorizado para un control general de la instalación mando embrague.



PELIGRO

No utilizar la motocicleta si el nivel se encuentra por debajo de la marca MIN; en éstas condiciones el circuito de mando del embrague podría no funcionar correctamente, con el consiguiente riesgo de pérdida del control del vehículo y accidentes. Si el líquido se encuentra por debajo de la marca MIN, dirigirse a un concesionario MV Agusta para efectuar la comprobación del sistema de embrague.



PELIGRO

Realizar el llenado del líquido mando embrague utilizando solamente el tipo de líquido recomendado en el § 1.4. de éste manual.





1.10. Neumáticos - Control y cambio



ATENCIÓN

Antes de usar el vehículo verificar siempre la presión de los neumáticos y las condiciones de desgaste.

El control de la presión de los neumáticos es un factor fundamental para garantizar seguridad en la conducción. Los neumáticos no inflados suficientemente empeoran la manejabilidad de la moto y se desgastan rápidamente; de lo contrario, presiones muy altas determinan menor superficie de contacto con el suelo y pueden reducir la adherencia del vehículo.

Antes de usar la moto es por lo tanto indispensable efectuar el control de la presión con los neumáticos a temperatura ambiente, es decir con la moto estacionada por tres horas.



PELIGRO

Un errado inflado de los neumáticos produce serios peligros durante el uso de la moto. Una presión insuficiente puede provocar el deslizamiento del neumático en la llanta o el desprendimiento con consiguiente aflojamiento del neumático y pérdida de control del vehículo.



Efectuar controles inmediatamente después de haber usado la moto, se obtendrían valores mas altos respecto a los efectivos y esto llevaría a una errada regulación de la presión de los neumáticos. El control de la presión de los neumáticos se debe realizar respetando los valores indicados en el § 3.2. y/o en la pegatina colocada sobre el tubo inferior de la horquilla delantera derecha. En el caso de largos recorridos aumentar el valor de la presión nominal de 0,2 bar.

Además antes del uso es extremadamente importante verificar las condiciones de desgaste de los neumáticos; los neumáticos desgastados están sometidos a pinchazos con mayor facilidad e influyen negativamente con la estabilidad y la manejabilidad de la moto. Durante la verificación asegurarse que la banda de rodadura no se encuentre por debajo del límite prescrito por el código del transito y que no tengan grietas. Además no deben tener clavos o fragmentos de vidrio, y los laterales no deben estar fisurados.

Presentando alguna de éstas condiciones hacer cambiar inmediatamente el neumático por un concesionario MV Agusta.



PELIGRO

El límite de la profundidad puede variar de un país a otro. Respetar siempre las disposiciones de la ley del país donde se utiliza el vehículo.



PELIGRO

- **Hacer cambiar los neumáticos excesivamente desgastados, por un concesionario MV Agusta. Además de ser ilegal, la utilización de la motocicleta con neumáticos excesivamente desgastados, reduce la estabilidad de la marcha y puede provocar la pérdida de control del vehículo.**
- **Si un neumático está pinchado o dañado no debe ser reparado, debe ser sustituido. Un neumático reparado**



garantiza prestaciones limitadas y nivel de seguridad inferior respecto a un neumático nuevo. Si se realiza una reparación provisoria o de emergencia a un neumático, conducir lentamente y con cautela hasta el mas cercano concesionario MV Agusta y cambiar el neumático. Después de la reparación de un neumático no alcanzar nunca la velocidad de 60 Km/h. La reparación no se puede realizar si el neumático está pinchado lateralmente, o si el agujero en la banda de rodado es mayor de 6 mm.

- Para la reparación de un neumático pinchado, MV Agusta recomienda no utilizar pegamentos líquidos. Estos pegamentos pueden influir negativamente en el material de las capas del neumático y no evidenciar daños secundarios provocados por eventuales objetos de penetración.

- Sustituir los neumáticos utilizando exclusivamente los prescritos en el § 3.2. Evitar además utilizar al mismo tiempo neumáticos del tipo y marca distintos entre ellos en la rueda delantera y trasera. Utilizar neumáticos no correctos puede influir negativamente en la manejabilidad y la estabilidad de la motocicleta, aumentando el riesgo de accidentes.

- Las llantas de la motocicleta han sido proyectadas para la utilización de neumáticos tubeless. No instalar neumáticos del tipo con cámara de aire en llantas para neumáticos tubeless. Los talones del neumático podrían no ajustarse correctamente y salir de las llantas, provocando el desinflado de los mismos con pérdida de control del vehículo.



- No instalar una cámara de aire en un neumático tubeless. El recalentamiento del neumático podría provocar la explosión de la cámara de aire provocando el desinflado del mismo con pérdida de control del vehículo.
- Montar un neumático de acuerdo a la dirección de rotación indicado por la flecha ubicada en los laterales de cada neumático.

- Los neumáticos nuevos deben ser sometidos a un periodo de rodaje antes de alcanzar la completa eficiencia; durante ésta fase es por lo tanto posible que los neumáticos tengan una adherencia relativamente escasa en determinadas superficies. Recomendamos por lo tanto conducir a una velocidad moderada y usar extrema cautela en la conducción por unos 100 km después del montaje del neumático nuevo.



ES
1

❑ Desmontaje de la rueda trasera



Prudencia - Precaución: En el caso fuera necesario cambiar el neumático trasero en un taller, cerciorares que en el desmontaje y el montaje de la rueda sean utilizados el siguiente úitillaje:

- Llave tubular poligonal de 55 mm
- Llave dinamométrica

Si dichas operaciones se realizaran con herramientas distintas, los componentes de la rueda trasera podrían dañarse seriamente. Aconsejamos por lo tanto no sustituir el neumático en un taller sin utillaje adecuado; de cualquier manera es preferible dirigirse a un concesionario MV Agusta.

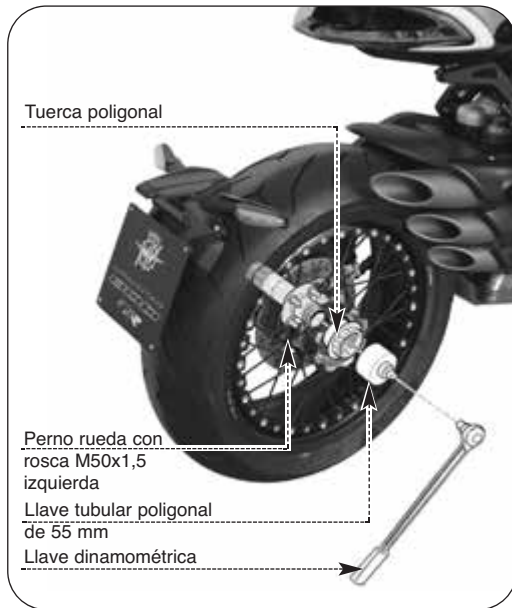



☐ Control de las ruedas

Antes de utilizar el vehículo controlar siempre que la llanta de la rueda no tenga grietas, pliegues o deformaciones.



PELIGRO

Si se encontraran daños, cambiar la rueda en un concesionario MV Agusta. No intentar efectuar reparaciones en la rueda aunque sean pequeñas.

En el caso de cambio de neumáticos o de la rueda, es necesario efectuar el balanceo de la rueda en un concesionario MV Agusta. El desequilibrio de la rueda puede perjudicar el rendimiento y la manejabilidad del vehículo y reducir la durabilidad de los neumáticos.



PELIGRO

Para efectuar el balanceo de la rueda utilizar exclusivamente contrapesos homologados. No es recomendable utilizar balanceadores líquidos o balanceadores líquidos/sellantes.



PELIGRO

No intentar quitar un neumático tubeless sin el utillaje específico necesario y las protecciones para la llanta. De lo contrario, podría dañarse o deformarse la superficie de sellado de la misma llanta, provocando el desinflado del neumático con pérdida de control del vehículo.



1.11. Cadena - Control y lubricación

Para efectuar las siguientes operaciones colocar la motocicleta sobre el caballete trasero, en un plano horizontal y con el cambio en neutro.

□ Control de la regulación



PELIGRO: Antes de comprobar el ajuste de cadena, dirigirse a un centro autorizado MV Agusta para verificar que el valor del equilibrado estático de la suspensión posterior está correcto. También cerciorarse de que la cadena esté lubricada correctamente.

El eje de la parte inferior de la cadena debe estar a una distancia de **116 mm** del cubrecadena inferior. Efectuar el control en varios puntos de la cadena girando manualmente la rueda trasera. El juego debe quedar prácticamente constante mientras gira la rueda; si la cadena presenta fuertes variaciones del juego, esto indica que algunas eslabones están aplastados, bloqueados o alargados. Si la distancia de la cadena del cubrecadena inferior es mayor de 116 mm, es necesario ajustar la cadena.

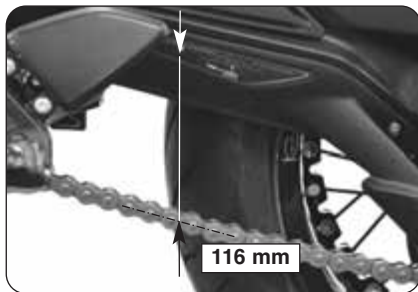



PELIGRO: Usar la motocicleta con la cadena en malas condiciones o mal regulada puede ser causa de accidentes. Antes de salir con la moto, efectuar el control de la cadena de acuerdo al presente capítulo. En el caso fuera necesaria la regulación de la tensión de la cadena, dirigirse a un centro asistencia autorizado MV Agusta.



PELIGRO: Si la cadena tiene eslabones aplastados, bloqueados o alargados, hacer la sustitución de la cadena por un centro asistencia autorizado MV Agusta.



PELIGRO: Si se detectan daños o desgaste excesivo de la cadena o de sus engranajes, es necesario dirigirse a un concesionario MV Agusta para la sustitución. Cada vez que se cambia una cadena, también los engranajes correspondientes deben ser sustituidos.



PELIGRO

Puede ser peligroso utilizar una cadena del tipo con falso eslabón. Un eslabón principal no remachada completamente o del tipo falso eslabón, puede abrirse y provocar accidentes o graves daños al motor. No utilizar nunca cadenas con falso eslabón.



PELIGRO

Cada vez que se solicita de funcionar los tornillos del cubo de la rueda posterior, dirigirse a un centro autorizado MV Agusta. Para apretar los tornillos, aplique un par de apriete igual al valor mostrado en la etiqueta puesta sobre el monobrazo. El uso de un par de apriete mayor que el valor indicado puede causar el decaimiento rápido del cubo de la rueda posterior, comprometiendo la confiabilidad del vehículo y la seguridad del piloto y del pasajero.



❑ Lubricación

La cadena debe estar correctamente lubricada para garantizar la máxima eficiencia.

► Limpieza preliminar: antes de efectuar la lubricación es necesario disolver los depósitos de suciedad en la cadena utilizando kerosene; estos depósitos deben ser sucesivamente eliminados con un trapo limpio y/o un chorro de aire.



Prudencia - Precaución: La cadena es del tipo con retenedores (O-RING); para evitar daños, no efectuar la limpieza de la cadena con chorros de vapor o agua con alta presión, ni utilizar gasolina o disolventes detergentes en comercio. La limpieza de la cadena se debe realizar exclusivamente con kerosene.



PELIGRO

El kerosene puede ser peligroso. El kerosene es inflamable. El contacto con el kerosene puede ser nocivo para los niños y los animales domésticos. Tener las llamas libres y objetos con temperatura elevada lejos del kerosene. Tener los niños y los animales domésticos lejos del kerosene. Eliminar de manera correcta el kerosene usado.



► **Lubricación:** aplicar una capa ligera y uniforme en toda la cadena teniendo cuidado en no echar en las zonas circundantes, especialmente en los neumáticos. Dirigir el aerosol del lubricante en los eslabones internos, para lubricar la superficie de los anillos de sellado y penetrar dentro del rodillo de cadena.



Prudencia - Precaución: Utilizar solamente el lubricante específico de la tabla § 1.4., para proteger la cadena de transmisión y evitar chorros de aceite cuando el vehículo está en movimiento.



PELIGRO: La lubricación de la cadena se debe realizar según los intervalos indicados en la Tabla de Manutención Programada de éste manual (ver § 1.2.). Es necesario efectuar ésta operación también después de haber conducido con lluvia o después de cada lavado de la motocicleta. Usar la motocicleta con la cadena en malas condiciones o no lubricadas puede generar accidentes.

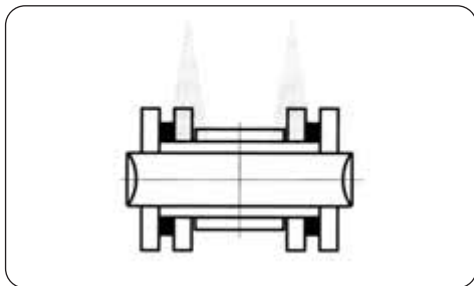



ES
1

1.12. Ralentí - Control

Efectúe el control con el motor a la temperatura de ejercicio.

El ralentí debe estar comprendido entre 1250 y 1350 rpm.

Si fuera necesario efectuar el ajuste, diríjase a los centros de asistencia autorizados.





1.13. Sistema de control de las emisiones de evaporación

Las motocicletas **MV Agusta DRAGSTER** están equipadas con un sistema de control de emisiones por evaporación, lo que impide el escape de vapores de la gasolina del tanque de combustible. Para mantener la eficiencia y la fiabilidad de este dispositivo, es necesario que las siguientes operaciones son realizadas por un centro asistencia autorizado MV Agusta.

Control (y sustitución si necesario)

Tubos y racores
Canister

Control (y limpieza si necesario)

Entrada del aire caliente



PRUDENCIA - PRECAUCIÓN:



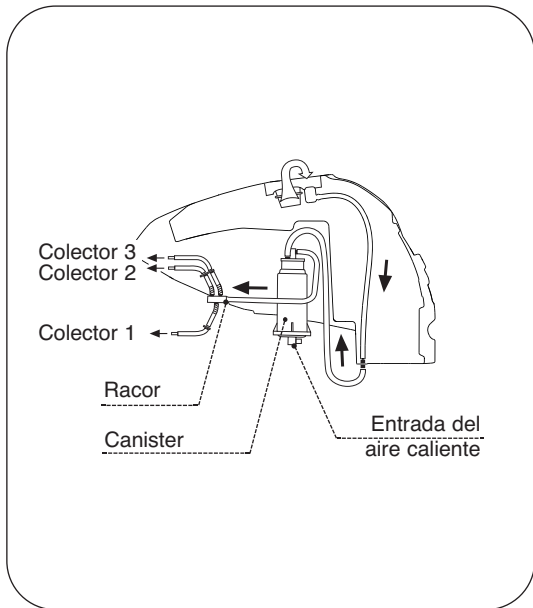



Las operaciones antes mencionadas deben ser realizadas según los intervalos indicados en la Tabla de Mantenimiento Programada de éste manual (ver § 1.2.).





1.14. Sustituciones - Información generales

La sustitución de los fusibles y de las bombillas (a excepción de las que se muestran en la tabla marcada ) , puede ser efectuada por el motociclista, siguiendo correctamente las indicaciones proporcionadas.

	Fusible de recarga batería - Sustitución (§1.14.1.)
	Fusibles - Sustitución (§1.14.1.)
	Luz de cruce - Sustitución bombilla (§1.14.2.)
	Luz de carretera - Sustitución bombilla (§1.14.3.)
	Indicadores de dirección - Sustitución
	Luz matrícula - Sustitución
	Faro trasero - Sustitución
	Luz stop trasera - Sustitución

1.14.1. Fusibles - Sustitución

► El fusible de recarga batería se encuentra sobre el telerruptor de arranque en la posición indicada en el lado derecho de la motocicleta. Para llegarlo es necesario desmontar la tapa de protección quitando los dos tornillos de fijación.

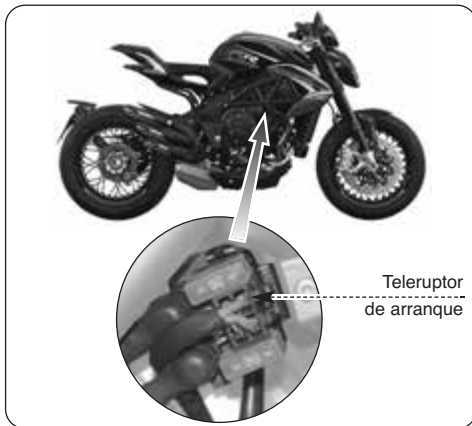



PRUDENCIA - PRECAUCIÓN

Poner el interruptor en “OFF” antes de controlar o sustituir los fusibles, para evitar cortocircuitos accidentales con el consiguiente riesgo de dañar otros componentes.

- ▶ Para sustituir el fusible es necesario intercambiar de posición el fusible de recarga batería con el fusible de repuesto.



PELIGRO

No utilizar nunca fusibles con valores distintos de los indicados, para evitar el daño a la instalación eléctrica de la motocicleta con peligro de incendio

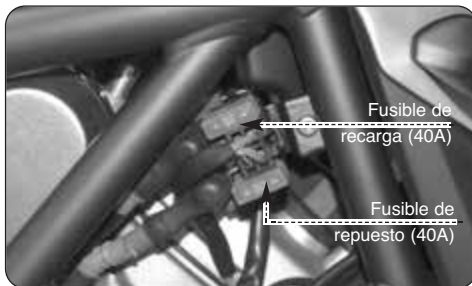



- ▶ Los fusibles de los servicios se encuentran en el lado derecho del vehículo.
- ▶ Desenganche y levante la tapa de la caja para acceder a los fusibles.



PRUDENCIA - PRECAUCIÓN

Poner el interruptor en “OFF” antes de controlar o sustituir los fusibles, para evitar cortocircuitos accidentales con el consiguiente riesgo de dañar otros componentes.





► Para identificar la posición y la función de los fusibles, consulte la información debajo de la tapa de la caja fusibles en el esquema eléctrico adjunto; las letras de referencia indicadas en la figura corresponden a las indicadas en el esquema.

Tenga presente que en la caja de fusibles hay cuatro fusibles de repuesto.

► Sustituya el fusible quemado y vuelva a montar la tapa.



PELIGRO

No utilizar nunca fusibles con valores distintos de los indicados, para evitar el daño a la instalación eléctrica de la motocicleta con peligro de incendio.

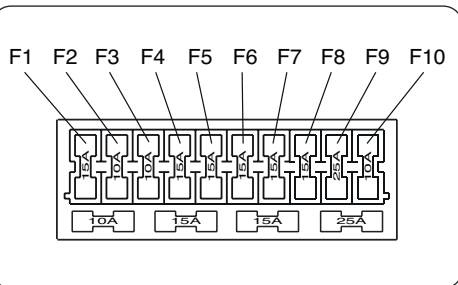



ES
1

1.14.2. Luz de cruce - Sustitución bombilla

► Quitar los cuatro tornillos que fijan el faro delantero, dos en el lado derecho y dos en el lado izquierdo del vehículo.



► Antes de quitar el faro delantero del vehículo, desconectar el conector ubicado en la parte posterior del faro y los conectores de los indicadores de dirección.

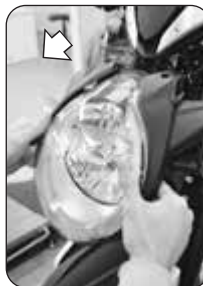



- ▶ Colocar el faro en una mesa con el fin de poder efectuar las siguientes operaciones.
- ▶ Quitar el tapón trasero.
- ▶ Girar el conector de la bombilla de la luz de cruce en sentido antihorario.
- ▶ Extraer la bombilla.
- ▶ Desconectar los conectores de la bombilla.



PRUDENCIA - PRECAUCIÓN: No tocar el vidrio de las bombillas con las manos. En caso de contacto limpiar con un producto desengrasante.

- ▶ Conectar los conectores a la bombilla nueva.
- ▶ Introducir la bombilla nueva.
- ▶ Girar el conector de la bombilla según las agujas del reloj.
- ▶ Volver a montar el tapón trasero, colocando correctamente las referencias de posición.
- ▶ Conectar nuevamente el conector del faro y los conectores de los indicadores de dirección.
- ▶ Colocar nuevamente el faro en el vehículo y enroscar los cuatro tornillos de fijación, prestando atención en colocar los cables en sus alojamientos.

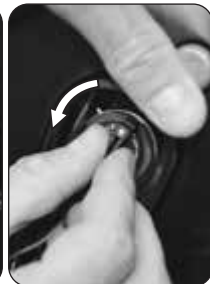

1 ES

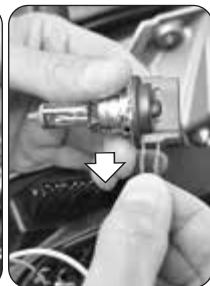



1.14.3. Luz de carretera - Sustitución bombilla

- ▶ Quitar el faro delantero de la moto como se describe en la sección §1.14.2.
- ▶ Desenganchar el muelle de retención de la bombilla de la luz de carretera.
- ▶ Extraer la bombilla.
- ▶ Desconectar el conector de la bombilla.



PRUDENCIA - PRECAUCIÓN: No tocar el vidrio de las bombillas con las manos. En caso de contacto limpiar con un producto desengrasante.

- ▶ Conectar el conector a la bombilla nueva.
- ▶ Introducir la bombilla nueva, colocando correctamente las referencias de posición.
- ▶ Enganchar nuevamente el muelle de retención.
- ▶ Volver a montar el faro delantero en la moto como se describe en la sección §1.14.2.

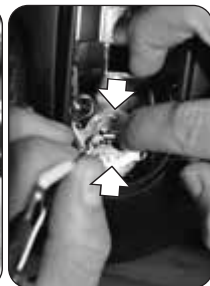



1.15. Batería

Esta motocicleta está equipada con una batería hermética instalada debajo del depósito carburante. La batería no precisa mantenimiento, por lo tanto no es necesario ni verificar el líquido ni añadir agua destilada.

Si la batería parece estar descargada (provocando problemas eléctricos o dificultad de arranque), cargarla lo antes posible en conectando el cargador al conector de recarga bajo el sillín del pasajero. Tener presente que la batería se descarga más rápido si la motocicleta posee accesorios eléctricos opcionales.



PELIGRO

Si la parte externa de la batería está dañada puede verificarse salida de ácido sulfúrico, substancia venenosa y extremadamente corrosiva. Evitar contactos con la piel, los ojos y la ropa y proteger siempre los ojos cuando trabajamos cerca de la batería.

En caso de contacto, prestar los **PRIMEROS AUXILIOS** de la siguiente manera.

- **CONTACTO EXTERNO:** Enjuagar con mucha agua.
- **CONTACTO INTERNO:** Tomar mucha agua o leche y llamar inmediatamente un médico.
- **OJOS:** Lavar con agua por 15 minutos y dirigirse inmediatamente a un médico. La salida del ácido sulfúrico provoca la formación de hidrógeno, el cual puede provocar una explosión en presencia de chispas o llamas.

Para efectuar la sustitución de la batería es necesario dirigirse a un centro autorizado MV Agusta.



ES
1

Larga inactividad

Si la motocicleta no será utilizada por largo tiempo (un mes o más), se recomienda quitar el fusible de recarga batería (ver §1.14.1). En caso de larga inactividad se recomienda de recargar la batería una vez al mes, para garantizar la durabilidad.

Para efectuar esta operación conectar el cargador al conector de recarga bajo el sillín del pasajero, con el fusible de recarga introducido en el telerruptor de arranque.

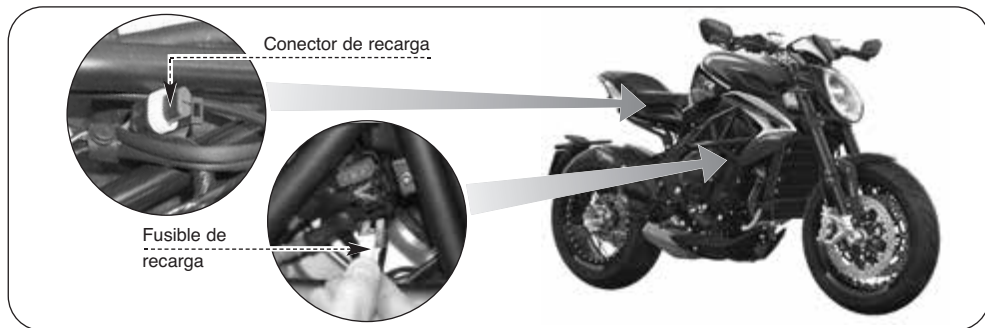



1.16. Limpieza de la motocicleta

La limpieza periódica y cuidadosa es importante para mantener en el tiempo el valor de la motocicleta, proteger el acabado de la superficie y controlar que no haya daños, desgastes o pérdida de líquido corrosivo.



Prudencia - Precaución: Antes de efectuar el lavado tapar los tubos de escape y proteger las partes eléctricas.



PELIGRO
Si la motocicleta está aún caliente, esperar que el motor y el escape estén fríos.



Prudencia - precaución: No utilizar máquinas de lavado con chorros de agua de alta presión o de vapor, puesto que pueden provocar infiltraciones de agua y dañar componentes de la motocicleta.



NOTA: Los detergentes contaminan el medioambiente. Por lo tanto la limpieza del vehículo debe ser realizada en una area equipada para la recolección y la depuración del líquido utilizado para el lavado.



Lavar con agua y esponja y no usar detergentes agresivos. Secar con un trapo suave. En las zonas menos accesibles usar un chorro de aire.



Prudencia - Precaución:

- Asegurarse que los trapos usados no hayan estado en contacto con productos de limpieza fuertes o abrasivos, disolventes, alcohol o gasolina.
- Para evitar daños irreversibles en los componentes de la carrocería no usar detergentes alcalinos o con elevada acidez, gasolina, líquido para frenos o otros disolventes.
- Si tienes dudas sobre la composición química del detergente, prueba su efecto aplicándolo en una poca área de la carrocería antes de usarlo en la motocicleta entera.

Periódicamente, tratar las partes pintadas con productos específicos. Si recorremos calles tratadas con productos corrosivos (sal) efectuar el

lavado apenas posible, utilizando agua fría; el agua caliente favorece la acción corrosiva.



PELIGRO: Asegurarse que no haya aceite o cera en los frenos o en los neumáticos. Si fuera necesario limpiar los discos de los frenos con un detergente para discos de frenos o acetona y lavar los neumáticos con agua caliente y detergente neutro.



PELIGRO: Si los frenos están mojados pueden provocar una reducción de la potencia de la frenada y accidentes. Después del lavado poner en marcha el motor por algunos minutos y saliendo despacio. Efectuar algunas frenadas con cuidado para secar las pastillas y discos de frenos.









PELIGRO: La cadena de la transmisión se debe lubricar después del lavado y el secado de la motocicleta de acuerdo a las instrucciones indicadas en el §1.11. de éste manual.



1.17. Periodo de larga inactividad

Si tiene previsto tener la motocicleta parada durante mucho tiempo, es conveniente efectuar las siguientes operaciones:

-  Vacíe el depósito combustible.
-  Quitar el fusible de recarga batería (§1.14.1). Recargar la batería una vez al mes. (§1.15.).
-  Quitar los capuchones de las bujías y las bujías. Echar una cucharada de aceite motor en cada orificio de las bujías, luego volver a instalar las bujías y los correspondientes capuchones y dejar girar algunas veces el motor.
-  Lubricar todos los cables de mando y los puntos de rotación de todas las levas y pedales.
-  Limpie la motocicleta y trate con productos específicos las partes pintadas (§1.16.).
-  Con el objeto de garantizar la integridad y las prestaciones de los neumáticos, estacionar la moto en un ambiente fresco, seco u oscuro con una temperatura casi constante e inferior a 25 °C. Evitar el contacto directo de los neumáticos con tubos o caloríferos de la calefacción, y el contacto prolongado con aceite y gasolina. Evitar colocar los neumáticos en las cercanías de motores eléctricos o herramientas donde se puedan desprender chispas o descargas eléctricas. Durante el tiempo de parada, tener la moto sobre el caballete trasero.
-  Tape la motocicleta con un telón adecuado.

Cuando vuelva a utilizar la motocicleta recuerde que debe efectuar la verificación general y, si fuera necesario, haga efectuar el mantenimiento (§1.2.).



2.1. Posición del conector de diagnóstico

El conector para el software de diagnóstico se encuentra bajo el sillín del piloto. Para acceder al conector, es necesario quitar el sillín como se describe en el párrafo §4.6. del Manual de Uso.

Para asegurar la conexión del hardware, es necesario conectar el cable de interfaz apropiado (a pedir al Servicio de las piezas de recambio de MV Agusta) al conector de diagnóstico.

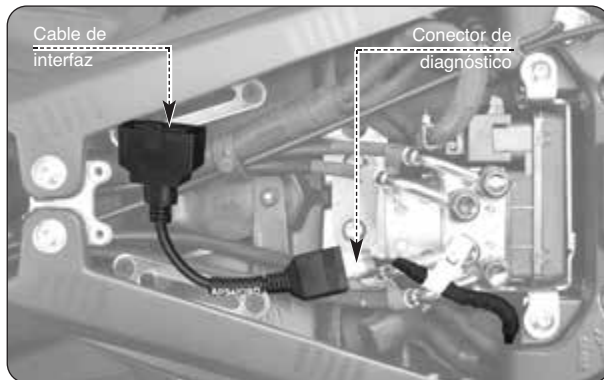

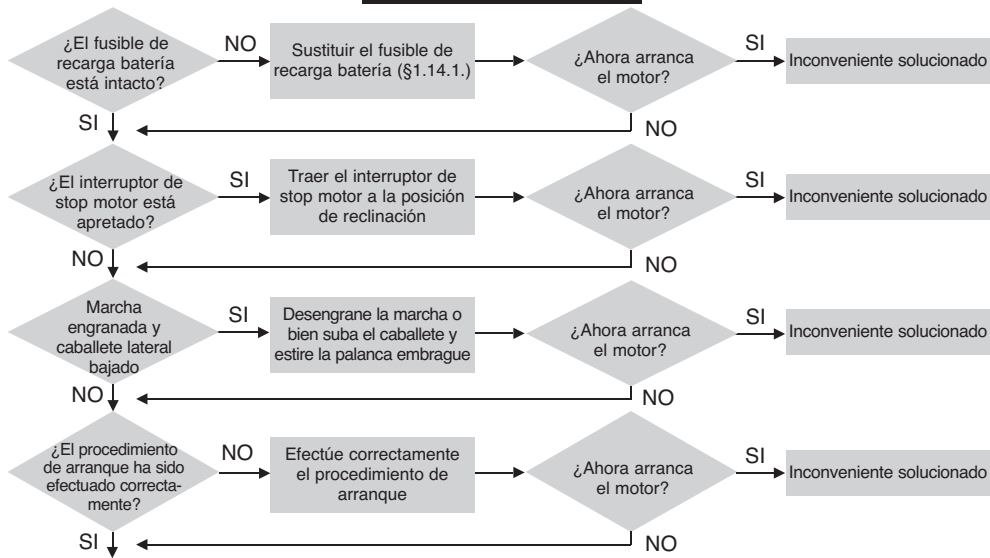
2.2. Inconvenientes en el motor: **EL MOTOR NO ARRANCA**

sigue en la página siguiente



sigue de la página anterior

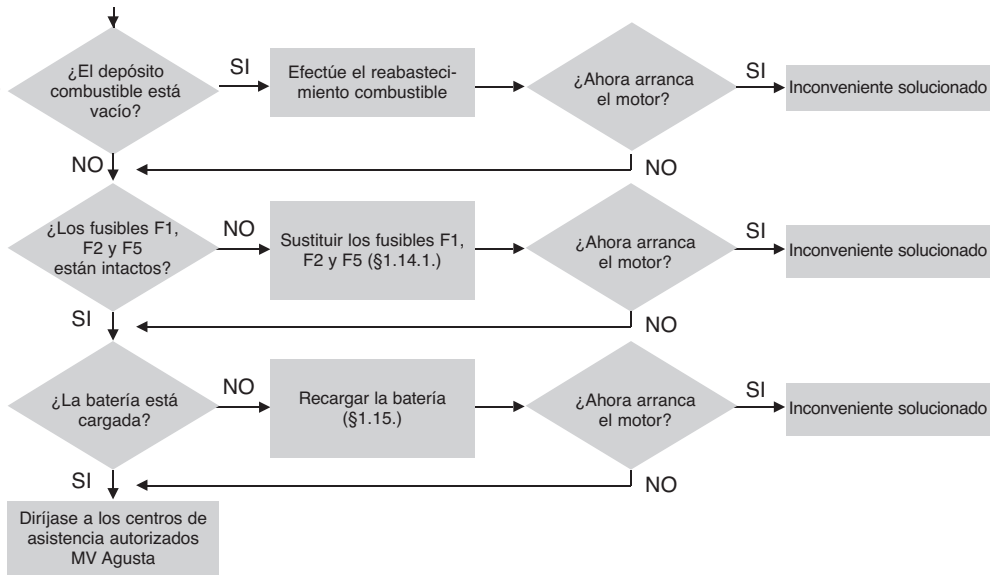



EL MOTOR SE APAGA MIENTRAS QUE ESTÁ FUNCIONANDO

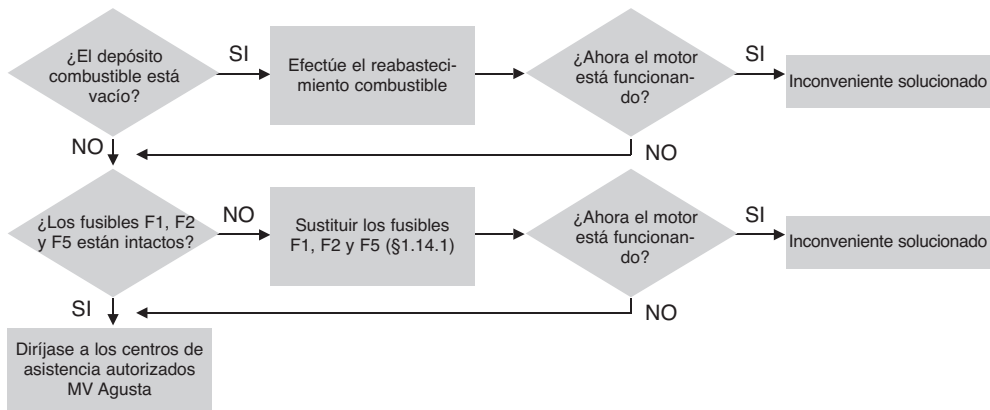

**EL MOTOR SE RECALIENTA**

ES 2

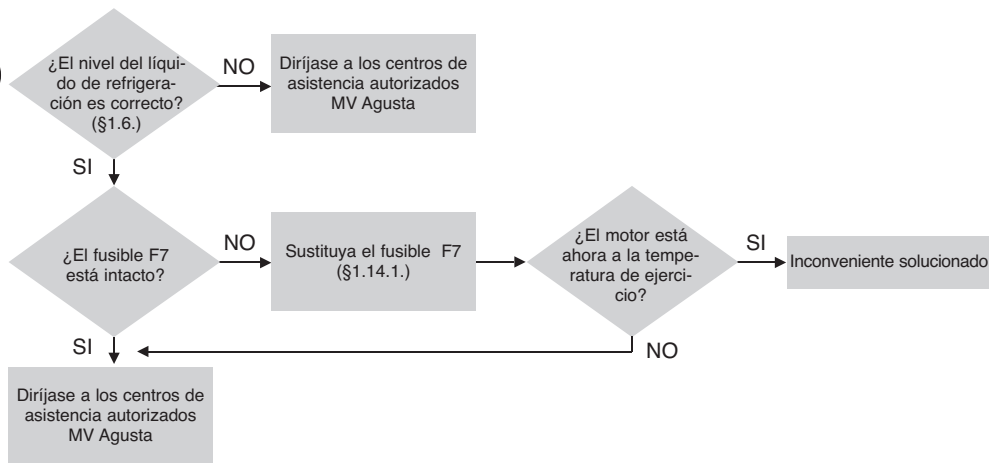



LA PRESIÓN DEL ACEITE ES INSUFICIENTE (El testigo de la presión del aceite está encendido mientras que el motor está funcionando)

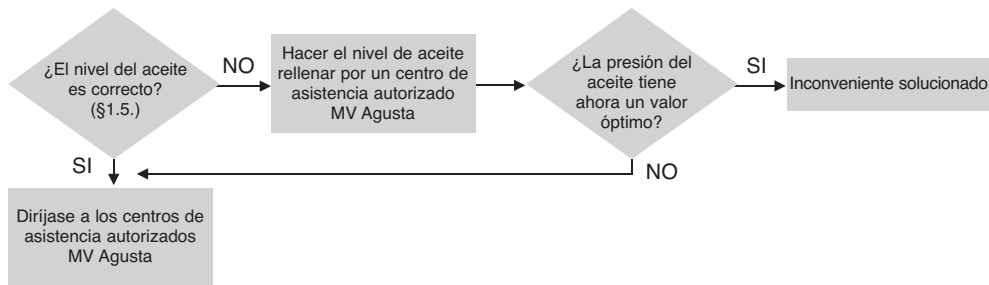



2.3. Inconvenientes en la instalación eléctrica: **LAS LUCES NO FUNCIONAN**

ES 2

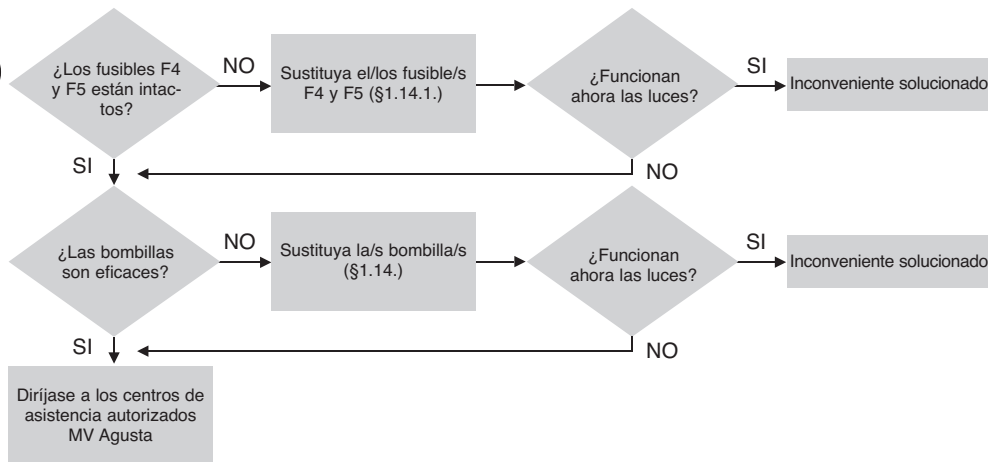



EL CLAXON NO FUNCIONA

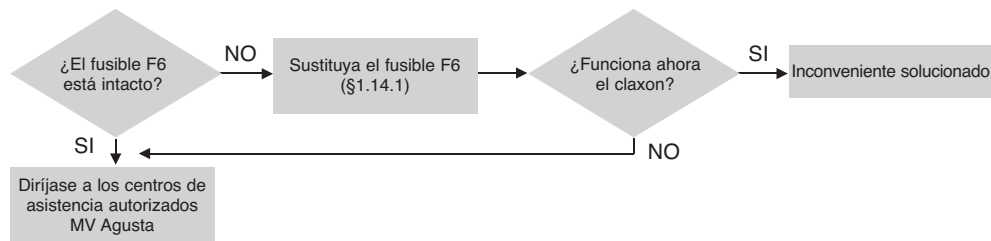

EL TABLERO DE INSTRUMENTOS NO FUNCIONA

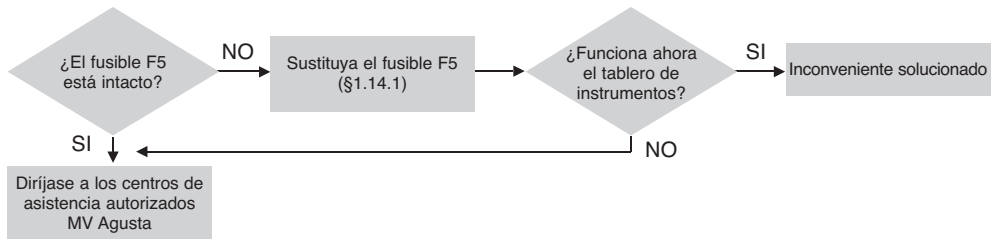



3.1. Descripción general de la motocicleta

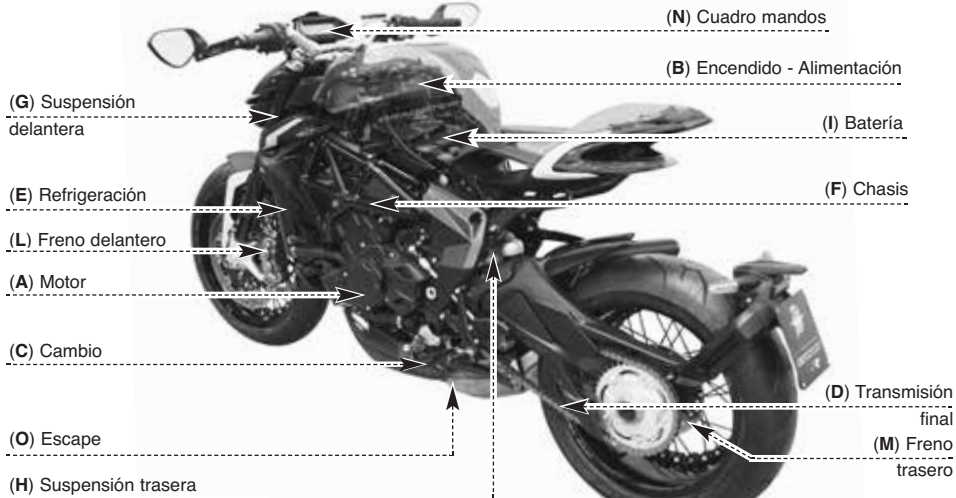



- A - Motor:** cuatro tiempos, tres cilindros en línea. Distribución mediante doble árbol de levas en cabeza. Lubricación por cárter húmedo.
- B - Encendido - Alimentación:** sistema integrado de encendido - inyección. Encendido electrónico por descarga inductiva. Inyección electrónica "Multipoint".
- C - Cambio:** del tipo extraíble, de 6 velocidades con engranajes siempre en toma.
- D - Transmisión final:** compuesta por piñón, corona y cadena.
- E - Refrigeración:** con radiadores separados del agua y del aceite.
- F - Chasis:** entramado, en tubular de acero, con placas laterales en aluminio.
- G - Suspensión delantera:** horquilla oleodinámica con vástagos vueltos, equipada con sistema exterior de regulación.
- H - Suspensión trasera:** de acción progresiva con monobrazo oscilante y monoamortiguador equipado con sistema exterior de regulación.
- I - Batería:** sellada y sin mantenimiento.
- L - Freno delantero:** doble disco semi-flotante con pinzas de cuatro pistones.
- M - Freno trasero:** disco único con pinza de dos pistones.
- N - Cuadro mandos:** equipado con testigos indicadores e instrumentos digitales.
- O - Escape:** equipado con convertidor catalítico para la reducción del gas de escape.



3.1.1. Sistema de frenado (ABS)

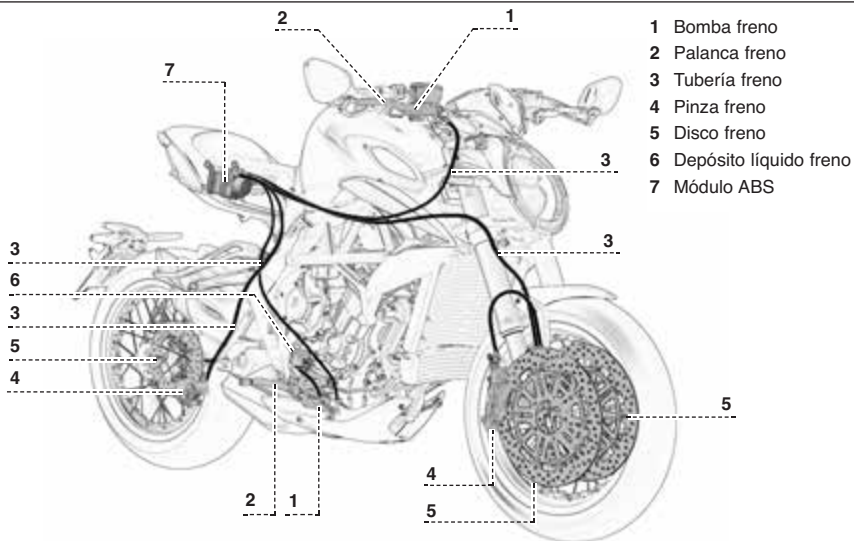

ES 3



3.1.2. Lubricación motor

- 1 Carter motor
- 2 Filtro aceite

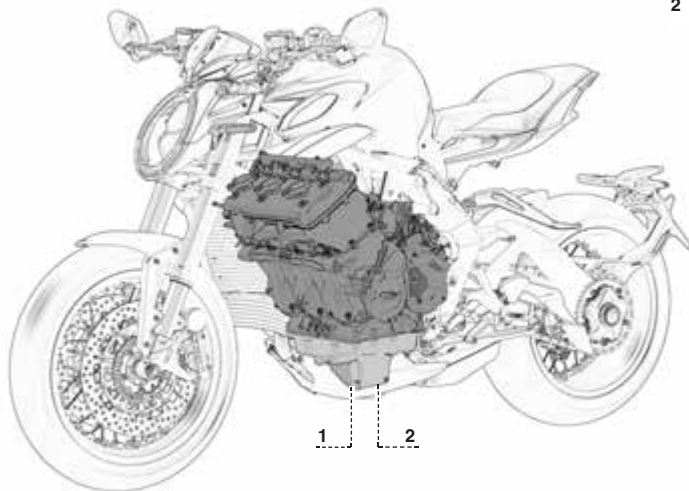



3.1.3. Circuito de refrigeración

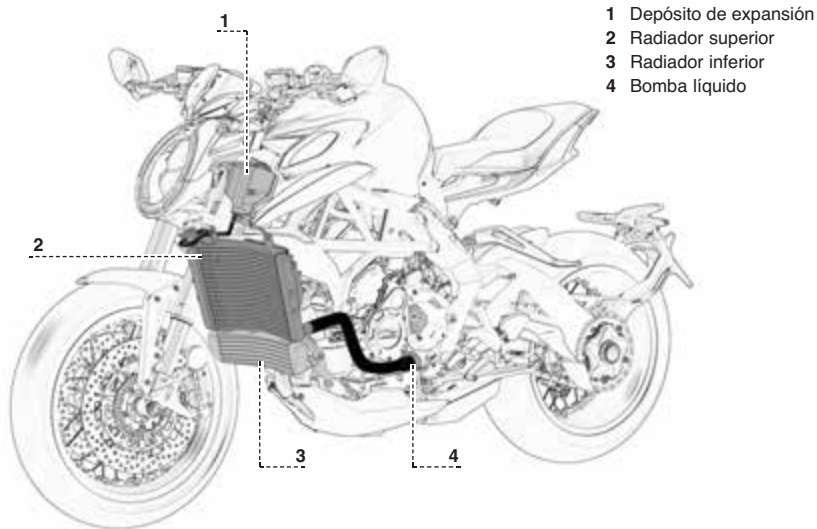



3.1.4. Circuito de alimentación

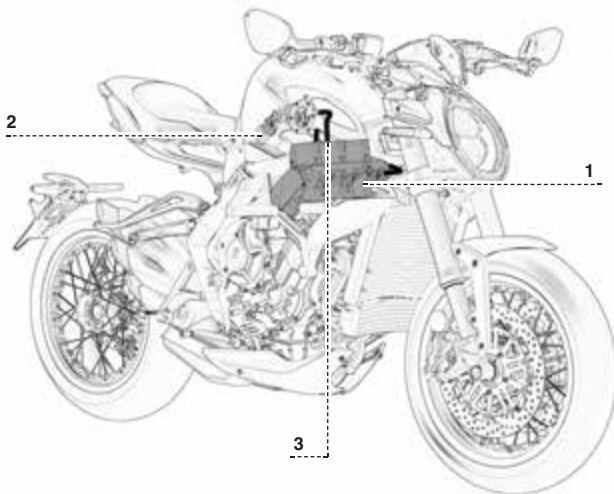

- 1 Cuerpo mariposa
- 2 Bomba carburante
- 3 Tubería carburante



3.2. Datos técnicos

Descripción	Dragster 800 Rosso	Dragster RR / RR SCS	Dragster RC / RC SCS
CARACTERÍSTICAS			
Distancia entre ejes (mm) (*)	1400	1400	1400
Longitud total (mm) (*)	2035	2035	2035
Ancho máx. (mm)	935	935	935
Altura asiento (mm) (*)	845	845	845
Altura mín. desde el suelo (mm) (*)	135	135	135
Avance carrera (mm) (*)	103,5	103,5	103,5

*: Los datos no son vinculantes. Los mismos son susceptibles a cambios en función de las variaciones aportadas al vehículo.



Datos técnicos

Descripción	Dragster 800 Rosso	Dragster RR / RR SCS	Dragster RC / RC SCS
Peso en seco (kg)	168	168	168
Capacidad depósito combustible (l) (*)	16,5	16,5	16,5
Reserva combustible (l) (*)	4	4	4
Cant. aceite en la bancada (kg)	2,5	2,5	2,5
MOTOR			
Tipo	Tres cilindros, 4 tiempos, 12 válvulas		
Alisado (mm)	79,0	79,0	79,0
Carrera (mm)	54,3	54,3	54,3
Cilindrada total (cm ³)	798	798	798
Relación de compresión	12,3 : 1	13,3 : 1	13,3 : 1
Norma medioambiental	Euro 4	Euro 4	Euro 4
Emisiones de CO ₂ (g/km)	128	163	163
Consumo de combustible (l/100 km)	5,6	6,7	6,7
Arranque	Eléctrico		
Refrigeración	Con radiadores separados del agua y del aceite		
Cárter motor y tapas	Fundido a presión		
Culata y cilindros	Fundidos en coquilla		
Válvulas	Acero		

* : Los datos no son vinculantes. Los mismos son susceptibles a cambios en función de la temperatura externa, de la temperatura del motor y del punto de evaporación de la gasolina utilizada.



Datos técnicos

Descripción	Dragster 800 Rosso	Dragster RR / RR SCS	Dragster RC / RC SCS
DISTRIBUCIÓN			
Tipo	Doble árbol de levas en cabeza		
LUBRIFICACIÓN			
Tipo	Por cárter húmedo		
ENCENDIDO - ALIMENTACIÓN			
Tipo	Sistema integrado de encendido-inyección MVICS. Centralita de control Eldor EM2.0; cuerpo mariposa full drive by wire Mikuni; bobinas pencil-coil con tecnología "ion-sensing", control de detonación y misfire. Control de par con 8 mapas; Traction Control con 8 niveles de intervención.		
Número de inyectores	3	6	6
Bujías	NGK CR9 EIB-9	NGK CR9 EIB-9	NGK CR9 EIB-9
Distancia electrodos (mm)	0.8 ÷ 0.9	0.8 ÷ 0.9	0.8 ÷ 0.9
EMBRAGUE			
Tipo	Multidisco en baño de aceite con control hidráulico con dispositivo mecánico anti-salto		
TRANSMISIÓN PRIMARIA			
Número dientes engranaje contralbero	Z = 22	Z = 22	Z = 22
Número dientes engranaje embrague	Z = 41	Z = 41	Z = 41
Relación de transmisión	1,864	1,864	1,864
TRANSMISIÓN SECUNDARIA			
Número dientes piñón	Z = 16	Z = 16	Z = 16
Número dientes corona	Z = 41	Z = 41	Z = 41
Relación de transmisión	2,563	2,563	2,563



Datos técnicos

Descripción	Dragster 800 Rosso	Dragster RR / RR SCS	Dragster RC / RC SCS
CAMBIO VELOCIDAD			
Tipo	Extraíble de seis velocidades con engranajes siempre en toma		
Relaciones cambio (relaciones totales)			
Primera	2.846 (13.593)	2.846 (13.593)	2.846 (13.593)
Segunda	2.187 (10.447)	2.125 (10.149)	2.125 (10.149)
Tercera	1.778 (8.635)	1.778 (8.635)	1.778 (8.635)
Cuarta	1.500 (7.165)	1.579 (7.541)	1.579 (7.541)
Quinta	1.318 (6.295)	1.429 (6.823)	1.429 (6.823)
Sexta	1.190 (5.684)	1.318 (6.295)	1.318 (6.295)
CHASIS			
Tipo	Tubular con castillete de refuerzo de acero ALS (soldado en MAG)		
Placas fulcro horquilla	Aleación de aluminio		
SUSPENSIÓN DELANTERA			
Tipo	Horquilla oleodinámica con vástagos vueltos equipada con sistema de regulación exterior y separado del freno en extensión, en compresión y de la precarga muelle		
Ø vástagos (mm)	43	43	43
Carrera sobre el eje patas (mm)	125	125	125
SUSPENSIÓN TRASERA			
Tipo	Progresiva, mono-amortiguador regulable en extensión, en compresión y en la precarga del muelle		
Basculante monobrazo	Aleación de aluminio		
Carrera rueda (mm)	124	124	124



Datos técnicos

Descripción	Dragster 800 Rosso	Dragster RR / RR SCS	Dragster RC / RC SCS
FRENO DELANTERO			
Tipo	De doble disco flotante con faja de frenado en acero		
Ø disco (mm)	320		
Brida disco	Acero		
Pinzas (diámetro pistones mm)	Radiales, de 4 pistones (Ø 32)		
FRENO TRASERO			
Tipo	De disco en acero		
Ø disco (mm)	220		
Pinza (diámetro pistones mm)	De 2 pistones (Ø 34)		
LLANTA DELANTERA			
Material	Aleación de aluminio	Rueda de radios - Aleación de aluminio	Forjado en aleación de aluminio
Dimensiones	3.50" x 17"	3.50" x 17"	3.50" x 17"
LLANTA TRASERA			
Material	Aleación de aluminio	Rueda de radios - Aleación de aluminio	Forjado en aleación de aluminio
Dimensiones	6.00" x 17"	6.00" x 17"	6.00" x 17"
NEUMÁTICOS			
Delantero	120/70 ZR 17 M/C (58 W)	120/70 ZR 17 M/C (58 W)	120/70 ZR 17 M/C (58 W)
Trasero	200/50 ZR 17 M/C (75 W)	200/50 ZR 17 M/C (75 W)	200/50 ZR 17 M/C (75 W)



Datos técnicos

Descripción	Dragster 800 Rosso	Dragster RR / RR SCS	Dragster RC / RC SCS
Marca y tipo	PIRELLI Diablo Rosso II	PIRELLI Diablo Rosso II	PIRELLI Diablo Rosso II
Presión de hinchado (*):			
Delantero	2.5 bar (36 psi)	2.5 bar (36 psi)	2.5 bar (36 psi)
Trasero	2.8 bar (41 psi)	2.8 bar (41 psi)	2.8 bar (41 psi)

INSTALACIÓN ELÉCTRICA

Tensión instalación	12 V
Luz cruce delantera	H11B 12V 55W
Luz carretera delantera	H3 12V 55W
Indicadores de dirección	LED
Luz de posición trasera	LED
Luz stop trasera	LED
Batería	12 V - 8,6Ah
Alternador	350 W a 5000 rpm

CARROCERÍA

Depósito	Material termoplástico		
Laterales depósito	Material termoplástico	Material termoplástico	Fibra de carbono
Laterales traseros	Material termoplástico		

* : En la eventualidad que se utilice neumáticos diferentes de los recomendados, tener en cuenta el valor de presión de inflado marcado por el constructor en el lateral del neumático.



Datos técnicos

Descripción	Dragster 800 Rosso	Dragster RR / RR SCS	Dragster RC / RC SCS
Protección tablero	Material termoplástico	Material termoplástico	Fibra de carbono
Guardabarros trasero	Material termoplástico	Material termoplástico	Fibra de carbono
Guardabarros delantero	Material termoplástico		
Soportes guardabarros delantero	Material termoplástico	Material termoplástico	Fibra de carbono
Laterales air-box	Material termoplástico		
Protecciones cadena	Material termoplástico		
Portamaticula	Material termoplástico		
Espejo retrovisores	Material termoplástico		
Protección tubo de escape	Aluminio		
Protecciones laterales radiador	Material termoplástico		





ES 3





3.3. Referencias de los colores de las superestructuras (Dragster 800 Rosso)

Las partes pintadas de las superestructuras tienen los siguientes colores:

1. - Deposito carburante:

Rojo F4 Ago
(Cod. Palinal 926R750)

- 2. - Lateral central derecho;
- 3. - Lateral central izquierdo;
- 4. - Lateral delantero derecho;
- 5. - Lateral delantero izquierdo;
- 6. - Lateral trasero derecho;
- 7. - Lateral trasero izquierdo:

Negro Carbon Metalizado
(Cod. Palinal 928.V311)





3.4. Referencias de los colores de las superestructuras (Dragster RR / RR SCS MY20)

Las partes pintadas de las superestructuras tienen los siguientes colores, en relación al correspondiente código del color de la motocicleta:

1. - Depósito carburante:

- Código color A:

Gris Noche

(Cod. Lechler LCH29902-662) +

Negro Carbon Metalizado

(Cod. Palinal 928.V311)

- Código color B:

Blanco ICE Nacarado

(Cod. Lechler 2902181) +

Negro Carbon Metalizado

(Cod. Palinal 928.V311)

2. - Lateral central derecho;

3. - Lateral central izquierdo:

Negro Carbon Metalizado

(Cod. Palinal 928.V311)

4. - Lateral delantero derecho;

5. - Lateral delantero izquierdo;

6. - Lateral trasero derecho;

7. - Lateral trasero izquierdo:

- Código color A:

Amarillo Metalizado Nacarado

(Cod. Lechler LCC00997 +

Lechler LCC00998)

- Código color B:

Verde Neón

(Cod. Lechler BDCR216)





3.5. Referencias de los colores de las superestructuras (Dragster RC / RC SCS MY20)

Las partes pintadas de las superestructuras tienen los siguientes colores:

1. - Depósito carburante;
2. - Lateral delantero derecho;
3. - Lateral delantero izquierdo:

Gris Avio Metalizado
(Cod. Palinal 928.T892) +
Negro Carbon Metalizado
(Cod. Palinal 928.V311)

4. - Guardabarros delantero;
5. - Lateral airbox derecho;
6. - Lateral airbox izquierdo;
7. - Lateral trasero derecho;
8. - Lateral trasero izquierdo:

Gris Avio Metalizado
(Cod. Palinal 928.T892)



ES
3

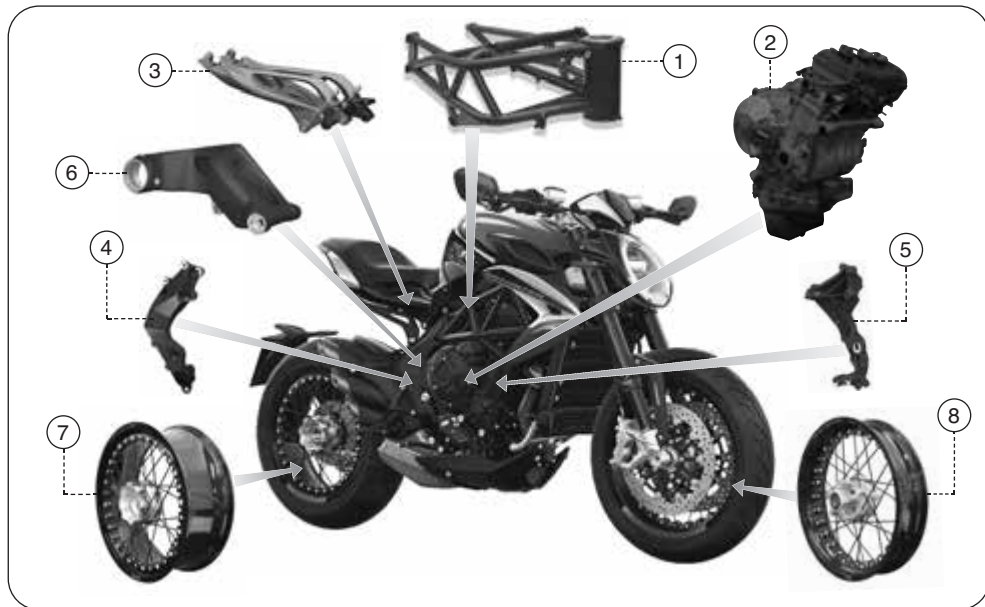



3.6. Referencias colores componentes del bastidor y parte ciclística

Las partes pintadas del bastidor y parte ciclística de la motocicleta tienen los siguientes colores, en relación al correspondiente código del color de la motocicleta:

1. - Bastidor:

- **Dragster 800 / RR / RR SCS MY20:**
Negro Brillante (Cod. PPG PCU 90207)
- **Dragster RC / RC SCS MY20:** Rojo Bastidor (Cod. Akzo Nobel QG000K Red)

3. - Bastidor trasero;

4. - Placa lateral derecha bastidor;

5. - Placa lateral izquierda bastidor;

6. - Horquilla trasera:

Negro Quasar
(Cod. Inver 61196 - Poliest/HD TGIC Free)

2. - Motor:

Negro Mate
(Cod. Pulverit 3500/0085)

7. - Llanta rueda trasera;

8. - Llanta rueda delantera:

- **Dragster 800 Rosso:** Negro Brillante
(Cod. Peter Lacke VPCH03250)
- **Dragster RR / RR SCS MY20:**
Negro Brillante
- **Dragster RC / RC SCS MY20:**
Rojo Brillante (Cod. Da Qiao
WFMY-S09-Q + WFMY-S10-Q)



Nota informativa

MV Agusta Motor S.p.A. está comprometida en una política de continuo mejoramiento de sus productos; por este motivo es posible encontrar ligeras diferencias entre el contenido de éste documento y el vehículo adquirido por Ustedes. Los modelos MV Agusta son exportados en muchos Países, en los cuales el Código del Tránsito y a los procedimientos de homologación son distintos a los nuestros.

Confiamos en Vuestra comprensión. MV Agusta Motor S.p.A. considera por lo tanto necesario reservarse el derecho de aportar modificaciones a sus productos y a la documentación técnica en cualquier momento y sin ningún aviso previo.

Sugerimos para visitar a menudo el sitio Internet www.mvagusta.com para obtener informaciones y actualizaciones sobre los productos MV Agusta y la documentación relacionada.



Respetemos y defendamos el medioambiente

Todo lo que hacemos tiene repercusiones para todo el planeta y en sus recursos.

MV Agusta, a tutela de los intereses de la comunidad, sensibiliza los Clientes y los operadores de la asistencia técnica a adoptar una utilización del vehículo y de eliminación de sus partes, respetando plenamente las normativas vigentes en términos de contaminación del medio ambiente, eliminación y reciclaje de los deshechos.

© 2020

Está prohibida la reproducción aunque sea parcial de éste documento sin el consentimiento escrito por MV Agusta Motor S.p.A.

Part. n° 8000C8714

Edición n° 1 - Enero 2020



SERVIZIO CLIENTI
CUSTOMER CARE

ITALIA N° VERDE: 800-36.44.06
ABROAD: +39 0332 254.724