



Motorcycle Art



MV AGUSTA F4 750 SPR

Use and maintenance manual

F4
SPR

MV AGUSTA

**F4
SPR**



Use and maintenance manual

Il presente Manuale di uso e manutenzione è disponibile nelle edizioni in lingua sotto specificate:

This Manual is available in the languages listed below:

Le présent livret d'utilisation et d'entretien est disponible dans les éditions rédigées dans les langues spécifiées ci-dessous:

Die vorliegende Bedienungs- und Wartungsanleitung ist in folgenden Sprachen erhältlich:

Las ediciones del presente manual de uso y mantenimiento están disponibles en los siguientes idiomas:

Codice/Code/Code
Bestell-Nr./Código

Edizione Italiana	Italian Edition	Edition Italienne	Italienische Ausgabe	Edición en Italiano	8000A0960
Edizione Inglese	English Edition	Edition Anglaise	Englische Ausgabe	Edición en Inglés	8A00A0960
Edizione Francese	French Edition	Edition Française	Französische Ausgabe	Edición en Francés	8B00A0960
Edizione Tedesca	German Edition	Edition Allemande	Deutsche Ausgabe	Edición en Alemán	8C00A0960
Edizione Spagnola	Spanish Edition	Edition Espagnole	Spanische Ausgabe	Edición en Español	8D00A0960
Edizione USA	USA Edition	Edition USA	USA Ausgabe	Edición USA	8000A0961

Dear Customer,

We wish to thank you for your preference and congratulate you on purchasing your new F4 SPR. Your choice is a reward for the passionate effort our technicians have put into giving the F4 SPR functional and aesthetic characteristics that place it above the finest motorcycles currently available on the market, making it an exclusive and sought-after item.

If, from a purely technical standpoint, the F4 SPR represents an internationally recognized point of reference on account of the innumerable innovations it introduces, its sleek, timeless design wonderfully combines a glorious past with the new millennium.

The combination of these elements, which was made possible by love of detail, passion, and the desire to realize a technically and aesthetically superior motorcycle, allows the F4 SPR to soar above passing fashions, giving it the privilege of being considered a unique item.

This booklet contains useful information on the periodic maintenance operations that are needed to keep the vehicle in full working order and maintain the warranty coverage.

For further information, please feel free to contact our Customer Care Service.

Have a good time!

MV Agusta
Claudio Castiglioni
Chairman



CONTENTS

chap.	Subjects covered	page
1	GENERAL INFORMATION	10
1.1	Purpose of the manual	10
1.2	Symbols	11
1.3	Warranty Booklet and Service Coupons	12
1.4	Identification data	13
2	SAFETY INFORMATION	20
2.1	Safety	20
2.1.1	Note on tampering	20
2.1.2	Safety rules	21
2.1.3	Installing accessories	23
2.1.4	Vehicle load	25
2.1.5	Modifications	26
2.1.6	Competitions	26
2.1.7	Recommendations for safe riding	27
2.1.8	Protective clothing	30
2.1.9	Suggestions against theft	31
2.2	Safety labels - Location	32
2.3	Safety - Visual and acoustic signals	37
3	CONTROLS AND INSTRUMENTS	38
3.1	Location of controls and instruments	38
3.2	Sidestand	39
3.3	Handlebar controls, left side	40

chap.	Subjects covered	page
3.4	Handlebar controls, right side	42
3.5	Ignition switch and steering lock	45
3.6	Gear lever	47
3.7	Instruments and warning lights	48
3.7.1	Warning lights	49
3.7.2	Multifunction display	50
4	OPERATION	51
4.1	Using the motorcycle	51
4.2	Running-in	52
4.3	Starting the engine	54
4.4	Selecting and setting the display functions	56
4.4.1	Selecting the display functions	57
4.4.2	Setting the measurement units	59
4.4.3	Resetting the trip mileage counters	62
4.4.4	Setting the clock	65
4.4.5	Chronometer	67
4.5	Refuelling	76
4.6	Glove compartment	77
4.7	Parking the motorcycle	78
4.8	Preriding checks	80
4.9	Riding	82



CONTENTS

chap.	Subjects covered	page
5	ADJUSTMENTS	83
5.1	List of adjustments	83
5.2	Table of adjustments	85
5.3	Adjusting the front brake lever	86
5.4	Adjusting the clutch lever	86
5.5	Adjusting the rearview mirrors	87
5.6	Adjusting the steering damper	87
5.7	Adjusting the front suspension	88
5.7.1	Spring preload	89
5.7.2	Rebound damper (front suspension)	89
5.7.3	Compression damper (front suspension)	90
5.8	Adjusting the rear suspension	90
5.8.1	Rebound damper (rear suspension)	92
5.8.2	High speed compression damper (rear suspension)	92
5.8.3	Low speed compression damper (rear suspension)	92
5.9.	Headlight adjustment	93
6	MAINTENANCE	94
6.1	Tables of scheduled maintenance and checks	94

chap.	Subjects covered	page
6.2	Tools and accessories supplied	104
6.3	Table of lubricants and fluids	105
6.4	Removing/fitting the right-hand side fairing	106
6.5	Checking the engine oil level	108
6.5.1	Topping up the engine oil level	109
6.6	Checking the coolant level	111
6.6.1	Topping up the coolant level	112
6.7	Checking the wear of the brake pads	114
6.8	Checking the brake fluid level	115
6.9	Checking the clutch fluid level	117
6.10	Checking and replacing the tyres	118
6.11	Checking and lubricating the drive chain	123
6.12	Checking the idle speed	127
6.13	Replacing parts - General information	128
6.13.1	Replacing the fuses	128
6.13.2	Replacing the low beam bulb	131
6.13.3	Replacing the high beam bulb	132
6.13.4	Replacing the front turn indicator bulbs	133
6.13.5	Replacing the rear turn indicator bulbs	134



CONTENTS

chap.	Subjects covered	page
6.13.6	Replacing the rear light and brake light bulb	135
6.13.7	Replacing the license plate light bulb	136
6.14	Battery	137
6.15	Cleaning the motorcycle	139
6.16	Prolonged inactivity	141
7	TROUBLESHOOTING FLOW CHART	142
7.1	Engine problems	142
7.2	Electrical equipment problems	147
8	TECHNICAL INFORMATION	150
8.1	Motorcycle overview	150
8.1.1	Front brake circuit	152
8.1.2	Rear brake circuit	153
8.1.3	Clutch circuit	154
8.1.4	Engine lubrication	155
8.1.5	Coolant circuit	156
8.1.6	Fuel system	157
8.2	Specifications	158
8.3	Carbon components	165
8.4	Accessories	166
8.5	Clothing	167



INDEX

A	
Accessories	166
– installation	23
Adjustments	
– clutch lever	86
– front brake lever	86
– front suspension	88
– headlight	93
– rear suspension	90
– rearview mirrors	87
– steering damper	87
– table	85

B	
Battery	137
Brakes	
– fluid level, check	115
– front brake circuit	152
– front brake lever, adjustment	86
– pads, wear check	114
– rear brake circuit	153
Bulbs, replacement of	
– front turn indicators	133
– high beam	132
– license plate light	136
– low beam	131
– rear light and brake light	135
– rear turn indicators	134

C	
Carbon components	165
Chain	
– check	123
– lubrication	125
Cleaning the motorcycle	139
Clutch	
– circuit	154
– fluid level, check	117
– lever, adjustment	86
Competitions	26
Controls and instruments, location	38
Coolant	
– level, check	111
– circuit	156
– topping up	112

D	
Damper	
– compression (front suspension)	90
– compression (rear suspension)	92
– rebound (front suspension)	89
– rebound (rear suspension)	92
Display, multifunction	50
– selecting functions	57
– setting measurement units	59



INDEX

E		
Electrical equipment, troubleshooting	147	
Engine		
– lubrication	155	
– oil level, check	108	
– oil level, topping up	109	
– serial number	13	
– starting	54	
– troubleshooting	142	
F		
Fuel system	157	
Fuses, replacement	128	
G		
Gear lever	47	
Glove compartment	77	
H		
Handlebar controls		
– left side	40	
– right side	42	
Headlight, adjustment	93	
– high beam, bulb replacement	132	
– low beam, bulb replacement	131	
I		
Identification data	13	
Idle speed, check	127	
Ignition switch and steering lock	45	
Instruments and warning lights	48	
L		
Levels		
– brake fluid	115	
– clutch fluid	117	
– coolant	111	
– engine oil	108	
License plate light, bulb replacement	136	
Location of controls and instruments	38	
Lubricants and fluids, table	105	
M		
Maintenance and checks, tables	94	
Motorcycle overview	150	
P		
Parking	78	
Pre-riding checks	80	
Prolonged inactivity	141	
Purpose of manual	10	



INDEX

R		
Rear light and brake light, bulb replacement	135	
Rearview mirrors, adjustment	87	
Refuelling	76	
Replacing parts, general information	128	
Running-in	52	
S		
Safety	20	
– labels, location	32	
– recommendations for safe riding	27	
– rules	21	
– visual and acoustic signals	37	
Scheduled maintenance tables	94	
Side fairing, right-hand, removal/refitting	106	
Sidestand	39	
Specifications	158	
Spring preload	89	
Steering damper, adjustment	87	
Suspensions		
– front, adjustment	88	
– rear, adjustment	90	
Symbols	11	
T		
Tampering, note	20	
Tools and accessories supplied	104	
Topping up		
– coolant	112	
– engine oil	109	
Troubleshooting flow chart		
– electrical equipment	147	
– engine	142	
Turn indicators		
– front, bulb replacement	133	
– rear, bulb replacement	134	
Tyres, check	118	
– puncturing	119	
– replacement	120	
V		
Vehicle		
– identification number	13	
– load	25	
– modifications	26	
W		
Warning lights	49	
Warranty		
– Booklet, Service Coupons and Dealers' Guide	12	



1.1. Purpose of the manual

In addition to providing directions on operation and maintenance, this manual contains important information about general safety: **READ THE MANUAL OVER CAREFULLY BEFORE FIRST USING THE MOTORCYCLE.**

The manual describes the model with the maximum equipment at print time.

This manual must be considered as a part of your motorcycle. It must always be kept in the glove compartment, and it must be included with the vehicle even if this one is sold back to another owner.



1.2. Symbols

Sections of text that are particularly important in terms of personal safety or possible damage to the motorcycle are marked with the following symbols:



Danger - Failure to observe these prescriptions, even in part, may pose a serious hazard to the driver's and other people's safety.



Caution - Failure to observe these prescriptions, even in part, may result in damage to the motorcycle.

The following symbols give an indication of who is supposed to perform the different adjustments and/or maintenance operations:



Information on operations that can be carried out by the user.



Information on operations that must be carried out only by authorized personnel.

The following symbols are used to provide further information:



The “” symbol points out the requirement to use a tool or a special equipment in order to correctly perform the described operation.



The “§” symbol refers the reader to the chapter identified by the number that follows.



1.3. Warranty Booklet and Service Coupons

Besides this Use and Maintenance Manual, the vehicle is accompanied by the following documents: a Warranty Booklet containing a Warranty and Pre-Delivery Certificate and recommended service coupons, and the MV Agusta Dealers' Guide.

IMPORTANT

The copy of the Warranty and Pre-Delivery Certificate to be sent to MV Agusta must be filled in by the dealer and returned to the factory within 10 days from the date of registration.

Every time the vehicle is serviced by a dealer, the user must produce the Warranty Booklet so that the dealer can fill in the service coupon and return it to MV Agusta within 10 days from the date of the servicing.

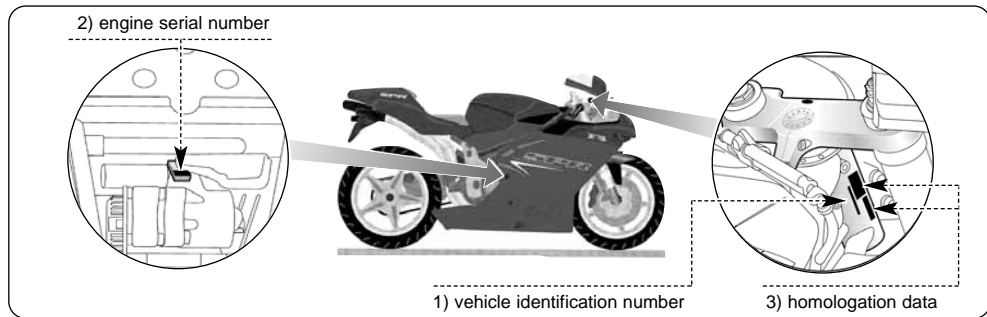

1.4. Identification data

- 1) vehicle identification number
- 2) engine serial number
- 3) homologation data

► **Motorcycle identification**

The motorcycle is identified by the vehicle identification number. When placing orders for spare parts, in addition to this number, you may be

required to provide the engine serial number and the key identification.

We recommend writing down the main numbers in the spaces provided below.

FRAME No.: _____

ENGINE No.: _____



1

Here below you can find a description of a vehicle identification number:

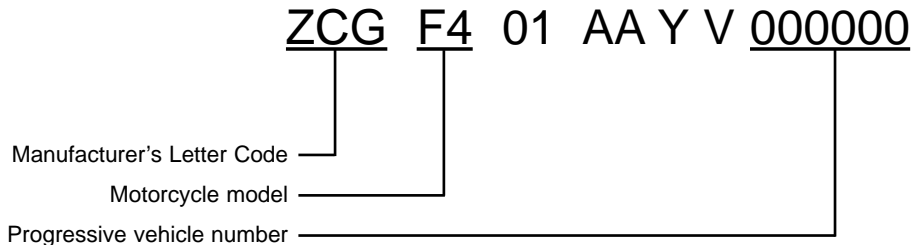

The vehicle identification number must be provided each time you need to contact the MV Agusta Technical Assistance Service, in order to guarantee the traceability of your motorcycle.



► **Motorcycle key identification**

A key is supplied in duplicate for both the ignition and all the locks. Keep the duplicate in a safe place.

When placing orders for spare keys, you may be required to provide the key identification number. We recommend writing down this number in the space provided below:

KEY No.: _____

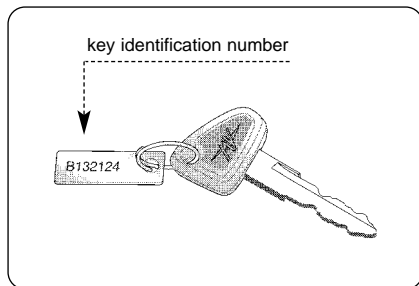



1

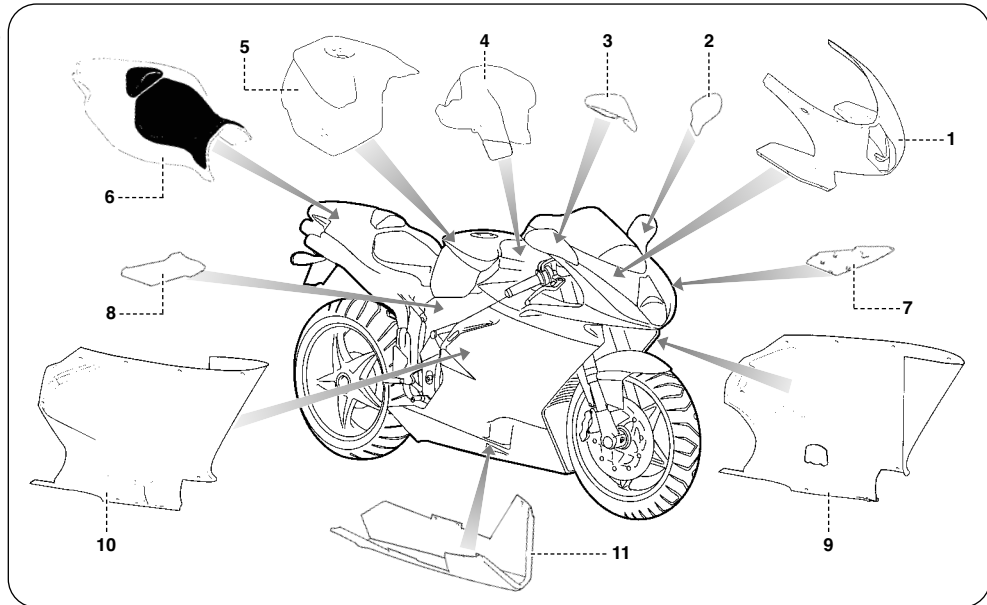



► **Bodywork parts reference colours**

Bodywork parts are painted with the following reference colours:

1. - **Front fairing;**
2. - **Left-hand rearview mirror;**
3. - **Right-hand rearview mirror;**
4. - **Air box;**
5. - **Fuel tank;**
6. - **Tail section;**
7. - **Fuel tank left-hand side fairing;**

8. - **Fuel tank right-hand side fairing;**
9. - **Left-hand side fairing;**
- 10.- **Right-hand side fairing;**
- 11.- **Undercowl;**

Black Painting - CRC 1951-6
(Code PPG *0036/1 + Code PPG *0036/2)



1

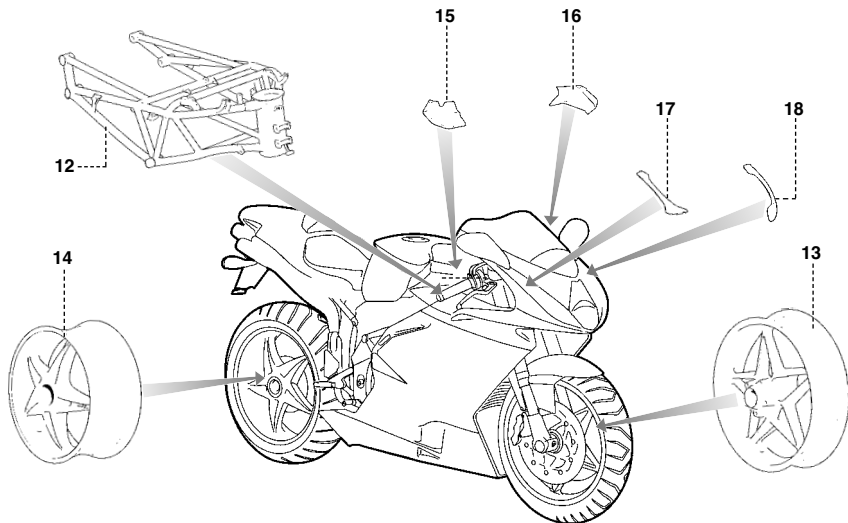



► Frame parts reference colours

Frame parts are painted with the following reference colours:

12.- Frame

Metal Bronze Painting
(Code Palinal 211E144)

13.- Front wheel rim

Aluminium Grey Painting
(Code Sebino 35204189) +
Clear Painting
(Code Sebino 35209052)

14.- Rear wheel rim

Aluminium Grey Painting
(Code Sebino 35204189) +
Clear Painting
(Code Sebino 35209052)

15.- Right-hand electrical equipment cover

Black Painting - CRC 1951-6
(Code Palinal 211E357)

16.- Left-hand electrical equipment cover

Black Painting - CRC 1951-6
(Code Palinal 211E357)

17.- Right-hand rearview mirror stand

Metal Bronze Painting
(Code Palinal 211E144)

18.- Left-hand rearview mirror stand

Metal Bronze Painting
(Code Palinal 211E144)



2.1. Safety

2.1.1. NOTE ON TAMPERING

2

Tampering with the noise control system is prohibited. In particular, the law prohibits the following acts:

1. The removal or rendering inoperative, other than for purposes of maintenance, repair, or replacement, of any device or element of design incorporated into any new vehicle for the purpose of noise control prior to its sale or delivery to the ultimate purchaser or while it is in use.
2. The use of the vehicle after such device or element of design has been removed or rendered inoperative.

Acts presumed to constitute tampering include:

1. The removal or piercing of the exhaust silencer, the diaphragm, the manifolds, or any other components involved in the transmission of exhaust gases.

2. The removal or piercing of any part of the intake system.
3. Poor maintenance.
4. The replacement of any movable parts of the vehicle or of any intake or exhaust components with parts or components other than those prescribed by the manufacturer.

NOTE

If you notice a progressive increase of the noise level of your motorcycle, MV Agusta recommends to have your noise control system controlled and if necessary replaced.

Otherwise, riding with a defective muffler can subject you to the penalties prescribed by state and local provisions.



2.1.2. SAFETY RULES



IMPORTANT: READ BEFORE USE

► **Before riding**, carefully read this manual so as to familiarize yourself with the controls, characteristics, working and limits of the motorcycle. The manual is aimed at providing information on some of all the possible techniques and methods required for safe riding.

► **Do not attach a sidecar, a trailer or any other accessory to the motorcycle.** Failure to observe this warning may make the vehicle unstable and cause serious accidents.

► **To ensure maximum reliability and maintain the vehicle in perfect working order**, it is essential to perform the servicing detailed in the Scheduled Maintenance Table and to follow all the instructions provided in this manual. For further information, speak with your dealer, who will have the necessary technical skills and information to assist you.

► **MV Agusta** continually strives to improve the quality of all of its motorcycles. Therefore, modifications that improve the performance of the bike are made as soon as they are developed. Therefore, your motorcycle may not be described exactly by the illustrations and text contained in this manual.

► **If you find difficulties in understanding any picture or information contained in this manual**, contact your MV Agusta dealer to obtain the necessary explanations.

► **If you find difficulties in reading any information contained in this manual**, contact your MV Agusta dealer.

► **In order to avoid compromising handling and stability of your motorcycle**, you should obey the following warnings:

- do not attach any object to the vehicle;
- do not remove any part and/or component;
- do not modify the vehicle in any way;
- do not wear garments that could adversely affect control and handling of the motorcycle.



- ▶ **Do not ride this motorcycle if you do not possess a regular driving licence.** Failure to heed this warning constitutes a breach of the Highway Code, besides posing a serious hazard to the driver's and other people's safety.
- ▶ **Do not try to service or repair this motorcycle if you do not possess the necessary skills.**
- ▶ **Motorcycle riding demands your complete attention.** Do not ride if you are ill, in poor physical condition, or because of worry, etc., unable to concentrate on the task at hand.
- ▶ **Always wear a helmet, even on short rides.**
- ▶ **Always wear suitable clothes, especially when travelling by night (e.g. garments with fluorescent bands).**
- ▶ **When refuelling, switch off the engine and refrain from smoking.**
- ▶ **When refuelling, stay away from the vehicle to avoid inhaling harmful fumes.** Should the fuel come into contact with the skin or clothes, immediately wash with water and change the contaminated garments.
- ▶ **Since petrol is highly flammable, avoid spilling the fuel onto the tank and the exhaust pipes when refuelling.**
- ▶ **Do not start the engine in closed places.** Exhaust gases are toxic and can quickly saturate the air and cause fainting or even death.
- ▶ **Before starting the engine in a closed place, ensure that the area is well ventilated.**
- ▶ **When travelling during the day, use the low beam.**
- ▶ **While the vehicle is in motion, always rest the feet on the specially designed supports.**
- ▶ **While riding, always keep both hands on the handlebars.**
- ▶ **Park the vehicle where it is unlikely to be bumped into or damaged.** Even slight or involuntary bumps can cause the vehicle to topple over, with subsequent risk of serious harm to people or children.
- ▶ **To prevent the vehicle from tipping over, never park it on soft or uneven ground, nor on asphalt strongly heated by the sun.**



► Engine and exhaust pipes become very hot during riding. Always park your motorcycle where people or children can not easily reach these parts, in order to avoid serious burns.

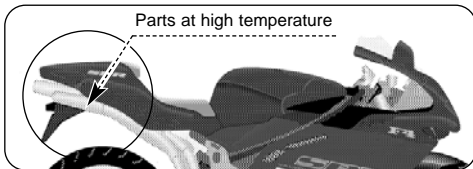

► Do not cover your motorcycle with a canvas soon afterwards riding. Before covering your motorcycle, wait until the engine and the exhaust pipes have thoroughly cooled.

► If your motorcycle has been involved in an accident, check all levers, wires, hoses, brake calipers and other main parts for damage. Do not use the vehicle if you detect a damage that could adversely affect safety. Have all the main parts checked by an authorized MV Agusta dealer, in order to verify the absence of defects and/or

damages that the owner could not be able to detect.

2.1.3. INSTALLING ACCESSORIES

MV Agusta provides a range of accessories specially designed for your vehicle. It is essential that these accessories are installed by an MV Agusta dealer.



WARNING

Use only MV Agusta original accessories. The use of non-genuine accessories can make the vehicle unsafe by reducing its handling, stability and the effectiveness of the braking system. For this reason, the installation of any non-genuine accessory makes the warranty null and void and relieves MV Agusta of all responsibility.



2

► **Every time you apply accessories that affect the weight and/or the aerodynamic characteristics of your motorcycle, they must be assembled on its lower side and near to its center, as much as it is possible. The brackets and the anchor bolts must be carefully checked after the assembling, to ensure a stable framework and an unmovable support for the accessory. In fact, an eventual breaking of these stands could cause dangerous situations during riding.**

► **Verify that the assembling of the accessories does not cause a reduction of the minimum ground clearance and of the inclination of your motorcycle. Moreover, verify that the assembling of the accessories does not cause any interference with the handling of the steering system, with the travel of the suspensions and/or with the movement of any other component involved in driving.**

► **Any accessory positioned on the handlebar or on the front fork can reduce the handling and adversely affect the stability of the vehicle.**

Therefore, the choice of the accessories should be accurate and restricted to components of light weight and small dimensions only.

► **Your motorcycle could undergo lightening or other instability effects in case of wind blowing sideways and transversely; this may also happen when your motorcycle runs into or it is overtaken by vehicles of great dimensions. Under these conditions, the accessories adversely affect your driving safety, especially if they are incorrectly assembled or of the wrong type. It is therefore necessary to pay great attention in choosing and assembling any accessory.**

► **Some accessories force the rider to drive in an unnatural position. This may obviously restrict your freedom of movement and cause loss of control of the vehicle.**

► **Additional electric accessories can cause an overload of the electrical system of your motorcycle; this could damage the wires, causing danger of short circuit and electric shock.**



2.1.4. VEHICLE LOAD

This motorcycle is designed for use by the rider only. To use the vehicle in complete safety and respect of the Highway Code provisions, it is essential not to exceed the maximum weight of the motorcycle, which corresponds to **325 kg**.

This value comes out from the sum of the following weights, according to the European standard CEE 92/61:

- weight of the motorcycle;
- weight of the driver;
- weight of the load and all the accessories.



WARNING: Since the load can strongly affect handling, braking, performance and safety characteristics of your motorcycle, you should always keep in mind the following warnings.

- **NEVER OVERLOAD YOUR MOTORCYCLE!** Driving an overloaded motorcycle can cause damage to the tyres, loss of control of the vehicle and serious

injury. Verify that the total weight (including the weight of the motorcycle, the driver, the load and all the accessories) does not exceed the maximum load values specified for your vehicle.

- Never carry any incorrectly fastened object on your motorcycle, because it could move from its position during riding.
- Steadily fasten the heaviest objects near the center of the motorcycle, and equally divide the load on both sides of the vehicle.
- Do not insert any object or accessory in the spaces on the frame trellis, in order to avoid interfering with the movable parts of the motorcycle.
- Before riding, always check the wear and the pressure of the tyres.
- Adjust the suspensions according to the load.
- Even if the motorcycle is correctly loaded, drive with caution and never exceed 130 km/h when you carry a load.



2.1.5. MODIFICATIONS

MV Agusta suggests neither to remove any original device, nor to modify the motorcycle in any way that could change its shape or its working.



WARNING

Any modifications made to the vehicle (e.g. alteration and/or removal of components) can make the vehicle unsafe or unlawful. MV Agusta cannot be held responsible for any damage to people and objects subsequent to eventual modifications made to the original conditions of your motorcycle. Modifying the vehicle immediately voids the warranty and relieves MV Agusta of all responsibility.

2.1.6. COMPETITIONS



WARNING

Riding the vehicle in competitions requires considerable skill and experience as well as an accurate setup of the motorcycle.

MV Agusta has designed a number of special components for use in competitions and/or sporting events. The use of such components is strictly limited to areas closed to traffic. Failure to observe this restriction constitutes a breach of the Highway Code for which **MV Agusta** cannot be held responsible.



2.1.7. RECOMMENDATIONS FOR SAFE RIDING

Besides being a means of transport, your motorcycle is a source of recreation and excitement. However, the configuration of the vehicle does not exclude a certain amount of risk. To ensure maximum safety, in addition to scrupulously observing the warnings and instructions provided in the previous paragraphs, it is essential to take a few additional precautions.

In particular:

Before starting off

Follow all the directions given in the section “PRE-RIDING CHECKS”. Conduct an overall check of all safety-related aspects of the motorcycle.

Familiarizing with the vehicle

The rider's ability and his mechanical skills form the basis of riding safety. It is advisable to practise riding in areas without traffic until you have become familiar with the vehicle and its controls.

Being aware of one's limits

When riding, never exceed your limits nor those imposed by law. Being aware of your limits and acting accordingly will help you avoid accidents.

Adverse weather conditions

Be very careful when riding in adverse weather conditions. On wet roads, for example, the braking distance increases as a result of reduced tyre traction. It is therefore necessary to travel at moderate speed and avoid abrupt braking and acceleration. Pay particular attention when riding on slippery surfaces such as road markings, manholes, level crossings, bridges, gratings, etc. Considering that a motorcycle cannot provide the same degree of shock protection as a motor vehicle, it is essential to adopt a “defensive” riding attitude, particularly in the adverse weather conditions described above.



► **Keeping even one foot or hand away from their designed supports could cause loss of control of the vehicle and increase the risk of accidents. Always keep both hands on the handlebars and both feet on the footrests during riding.**

► **Change gears as necessary to ensure that the proper gear ratio is chosen in all riding conditions, allowing the engine to run at optimum speed at all times. Avoid high gear ratios when travelling at reduced speed (excessively low rpm) as well as low gear ratios when travelling at high speed (excessively high rpm).**

► **Always operate the clutch system when you change gear, in order to avoid damage of the engine, of the gearbox and of the transmission. These components have not been designed to take the shocking stress caused by the forced coupling of a gear.**

► **Do not keep the clutch disengaged for a long time during riding, unless you have to change gear. Failure to heed this warning may lead to the**

overheating and to the abnormal wear of the clutch components.

► **When rapid acceleration is required (e.g. when passing), select a lower gear to obtain better acceleration.**

► **When the motorcycle is being ridden at high speed, gearing down several times in rapid succession can cause the engine to overspeed. As a result, the rear wheel may lock, causing loss of control of the vehicle, as well as damage to the engine and transmission.**

► **When riding down long hills, reduce the speed of your motorcycle by closing the throttle and using a low gear ratio to take advantage of engine braking. Use the front and rear brakes as little as possible to maintain your speed, in order to prevent brake overheating and fade.**

► **Special attention should be given to the braking system, which plays a key role in ensuring safety. When braking, always take account of the speed of the vehicle and the condition of the road surface.**



The braking action should always be applied gently and gradually to both wheels.

Performing this operation and, more in general, riding the vehicle always requires the utmost care. Therefore, caution should be exercised by all users, and in particular by inexperienced riders.

► **When you make a turn, avoid sudden braking.** Failure to observe this warning could lead to the sliding of the wheels and the loss of control of the vehicle. Always operate the brakes before starting a turn.

► **When you are laterally blown by a sudden gust of wind (as it may happen when you're overtaken by a vehicle of great dimensions, when you come out of a tunnel or when you're driving in a hilly zone), you could lose control of the vehicle.** While driving under the above mentioned conditions, reduce your speed and be careful to avoid sideways gusts of wind.

► **Maintain a safe distance behind vehicles in front of you and adjust your speed to the weather and traffic conditions.** Remember that, as your bike picks up speed, stopping distances increase and the motorcycle becomes more difficult to control. In any case, never exceed the speed limits imposed by the Highway Code.

► **When travelling during the day keep the low beam on, in order to be better seen by other road users.**

► **It is strictly forbidden to drink alcoholic beverages or take drugs before riding.** Even very small amounts of these substances adversely affect the rider's ability to control the vehicle.



2.1.8. PROTECTIVE CLOTHING

Helmet wearing is compulsory under the Highway Code. Helmet is the most important part in the biker's protective clothing, because it protects him from head injury in the event of an accident. Always fasten your helmet properly and securely. If you wear an open-face helmet, also wear goggles. Without a protective shield, in fact, wind racing on your face during driving could reduce your visual capacity, increasing the risk of accidents.



WARNING

Failure to wear a helmet increases the risk of serious injury or even death in the event of an accident. Make sure that you always wear an approved helmet during driving. If you wear an open-face helmet, also wear protective glasses.

Always wear suitable protective clothing. In particular, the following items should be worn:

- ▶ A close fitting jacket, made of tough material and easy to fasten.
- ▶ Supple, reinforced gloves providing both sensitivity and protection.
- ▶ Strong, close-fitting trousers covering the legs completely.
- ▶ Soft, reinforced boots providing both sensitivity and protection.

The items mentioned above are available from any specialized shop.

We recommend buying brightly coloured clothes, as they make the rider easier to see at night and in the fog.

In any case, the clothes must allow complete freedom of movement and not hamper the rider in any way. In addition, they must have no loose parts capable of catching in the control levers, the footrests, the wheels, the drive chain, etc., in order to avoid dangerous situations.

**WARNING**

Protective clothes do not afford complete protection against the risk of personal injury in the event of an accident. It is therefore essential not be deceived by the false sense of security that you might perceive by wearing protective clothing. When riding, always adopt a cautious attitude and follow the recommendations given in the previous paragraphs.

2.1.9. SUGGESTIONS AGAINST THEFT

1. Every time you park your motorcycle, operate the steering lock and remove the ignition key (see § 3.5.).
2. Park your motorcycle in a closed garage every time it is possible.
3. Install a good quality anti-theft device on your vehicle.

4. Always keep up to date the registration data of your motorcycle.
5. Write down your name, address and phone number in the spaces provided down below, and always keep this owner's manual inside the glove compartment of your motorcycle (see § 4.6.). This is very important, because a stolen motorcycle can be subsequently identified by reading the informations written in the manual found inside it.

NAME: _____

ADDRESS: _____

PHONE NUMBER: _____



2.2. Safety Labels - Location

- 1 - Windscreen warning
- 2 - Steering damper
- 3 - Unleaded petrol
- 4 - Battery warning
- 5 - Tyre pressure
- 6 - Rear wheel hub warning
- 7 - Chain adjustment

NOTE

The labels in the following pages do not appear in their real size. If you find difficulties in understanding any of these labels, contact an authorized MV Agusta dealer.

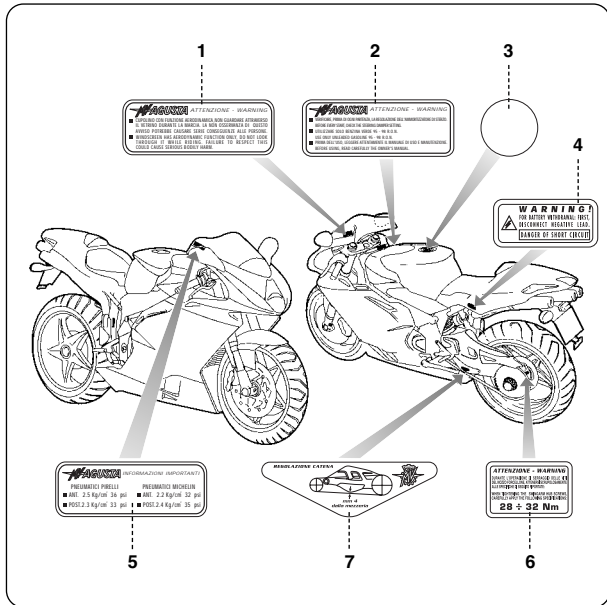



1. ADHESIVE LABEL
WINDSCREEN WARNING

MVAGUSTA ATTENZIONE - WARNING

- CUPOLINO CON FUNZIONE AERODINAMICA, NON GUARDARE ATTRAVERSO IL VETRINO DURANTE LA MARCIA. LA NON OSSERVANZA DI QUESTO AVVISO POTREBBE CAUSARE SERIE CONSEGUENZE ALLE PERSONE.
- WINDSCREEN HAS AERODYNAMIC FUNCTION ONLY, DO NOT LOOK THROUGH IT WHILE RIDING. FAILURE TO RESPECT THIS COULD CAUSE SERIOUS BODILY HARM.

2

2. ADHESIVE LABEL
STEERING DAMPER

MVAGUSTA ATTENZIONE - WARNING

- VERIFICARE, PRIMA DI OGNI PARTENZA, LA REGOLAZIONE DELL'AMMORTIZZATORE DI STERZO. BEFORE EVERY START, CHECK THE STEERING DAMPER SETTING.
- UTILIZZARE SOLO BENZINA VERDE 95 - 98 R.O.N. USE ONLY UNLEADED GASOLINE 95 - 98 R.O.N.
- PRIMA DELL'USO, LEGGERE ATTENTAMENTE IL MANUALE DI USO E MANUTENZIONE. BEFORE USING, READ CAREFULLY THE OWNER'S MANUAL.



3. ADHESIVE LABEL
UNLEADED PETROL

2

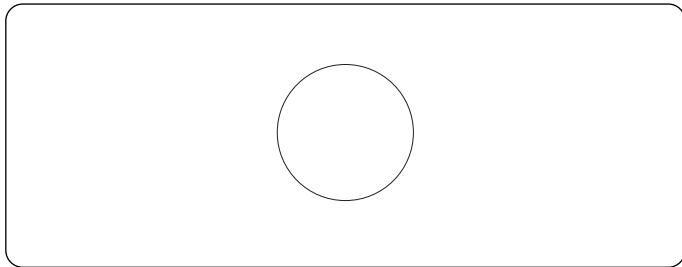

4. ADHESIVE LABEL
BATTERY WARNING





5. ADHESIVE LABEL
TYRE PRESSURE

MV AGUSTA INFORMAZIONI IMPORTANTI

PNEUMATICI PIRELLI

PNEUMATICI MICHELIN

■ ANT. 2.5 Kg/cm² 36 psi

■ ANT. 2.2 Kg/cm² 32 psi

■ POST. 2.3 Kg/cm² 33 psi

■ POST. 2.4 Kg/cm² 35 psi

2

6. ADHESIVE LABEL
REAR WHEEL HUB
WARNING

ATTENZIONE - WARNING

DURANTE L'OPERAZIONE DI SERRAGGIO DELLE VITI
DEL MOZZO FORCELLONE, ATTENDERSI SCRUPolosAMENTE
ALLE SPECIFICHE DI SEGUITO RIPORTATE:

WHEN TIGHTENING THE SWINGARM HUB SCREWS,
CAREFULLY APPLY THE FOLLOWING SPECIFICATIONS:

28 ÷ 32 Nm



**7. ADHESIVE LABEL
CHAIN ADJUSTMENT**

2

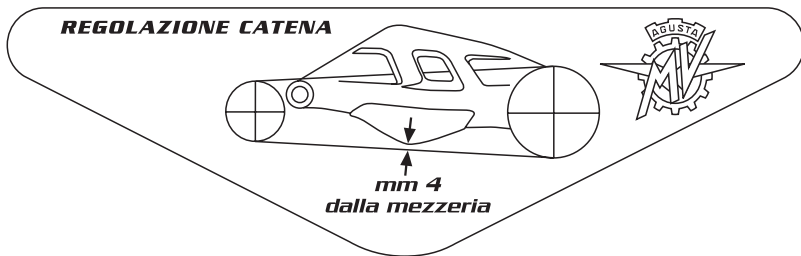



2.3. Safety - Visual and acoustic signals

Before each ride, it is essential to verify the operation of the visual and acoustic signals.

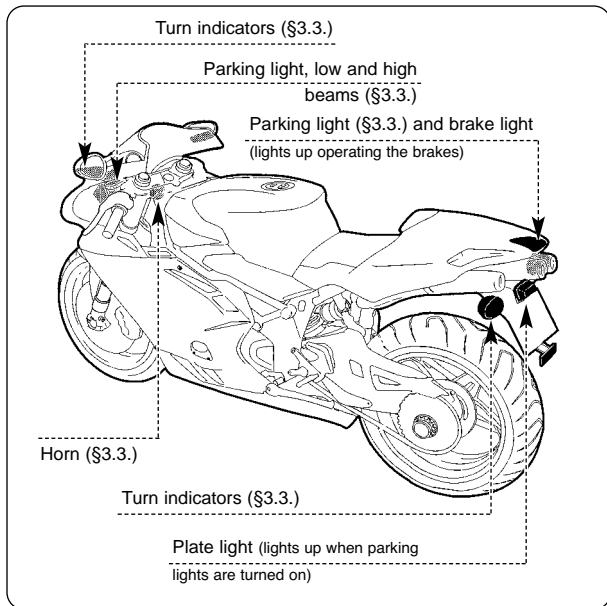



3.1. Location of controls and instruments

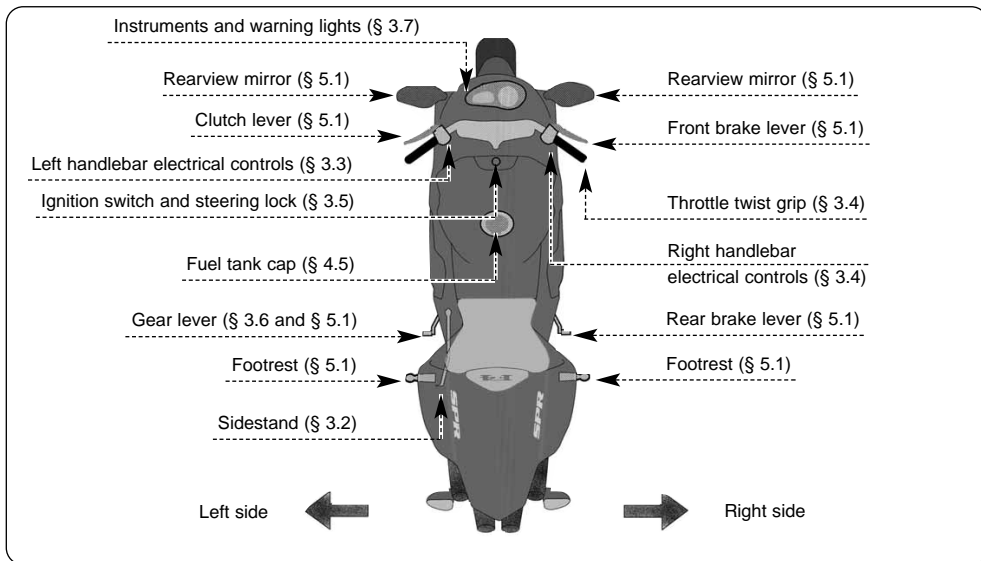



3.2. Sidestand

The sidestand is equipped with a safety switch that prevents the motorcycle from moving off while the stand is down.

If the rider attempts to engage the gears while the engine is running and the stand is down, the switch automatically turns off the engine by cutting the current supply.

If the motorcycle is parked (side-stand down) and the gears are engaged, the switch prevents the engine from being started, thereby avoiding the risk of accidentally toppling the vehicle.

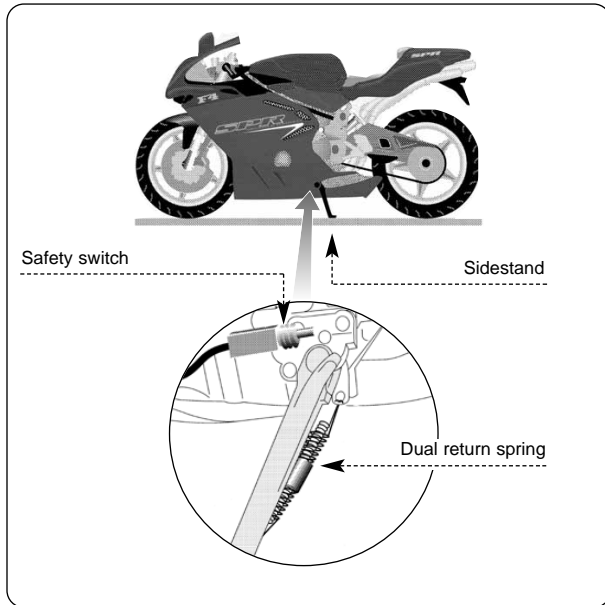



3.3. Handlebar controls, left side

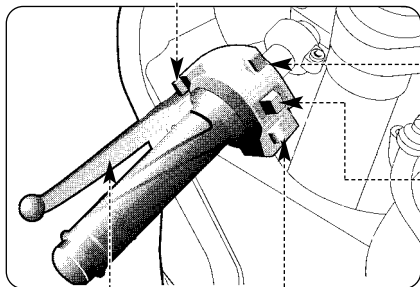

3



High beam flasher button

Press the button repeatedly.

Low/high beam button

Button not pressed in  : low beam 

Button pressed in  : high beam 

Turn indicator switch

Shifting the lever to the left or right switches on the left or right turn indicators. The switch then returns to the central position. Press to turn off the indicators.

Horn button

Press to operate the warning horn.

Clutch lever

Move towards/away from the handgrip to release/engage the clutch.

**High beam flasher button**

It is used to attract the attention of other road users in case of danger. When the high beam is on, the function is inactive.

Low/high beam button

Under normal conditions, the low beam is on. The high beam can be switched on by pressing the button when allowed by the traffic and road conditions.

Turn indicator switch

It is used to show the rider's intention to change direction or lane.

**WARNING**

Failure to switch the turn indicators on or off at the right time may cause an accident in that the other road users may draw incorrect conclusions about the direction of motion of the vehicle. Always switch on the indicators before turning or changing lanes. Then be sure to switch off the indicators after completing the operation.

Horn button

It is used to attract the attention of other road users in case of danger.

Clutch lever

It engages/disengages the clutch through a hydraulically controlled device.



3.4. Handlebar controls, right side

Engine stop switch

Stops the engine and prevents it from being restarted.

Engine start button

Starts the engine. To be released as soon as the engine starts. When the engine is running, pressing the button selects the display functions.

Cold start (choke) lever

Rotate clockwise when cold starting. After the engine has run for a few seconds, return the lever to its original position.

Throttle twist grip

Rotate counterclockwise to increase engine speed.

Front brake lever

Pull to the lever to apply the front brake.

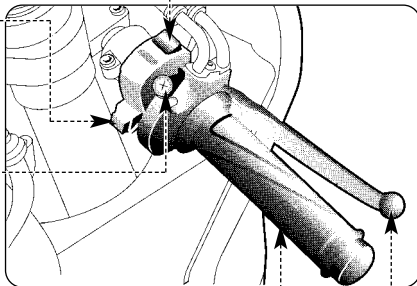



Engine stop switch

It is used to switch off the engine in an emergency. The ignition circuit is disabled, preventing the engine from being restarted. To be able to restart the engine, return the switch to its original position.

NOTE

Under normal conditions, do not use this switch to shut off the engine.

Engine start button

It is used to start the engine and, when the engine is running, to select the different functions of the display installed on the instrument panel.



CAUTION

To avoid damaging the electrical equipment, be sure not to hold down the button for longer than 5 consecutive seconds.

If, after some attempts, the engine does not start, refer to the chapter “TROUBLESHOOTING” later in this manual.

Cold start (choke) lever

It facilitates cold starting by slightly enriching the fuel-air mixture during start-up.

NOTE

This function must remain active only for a short time depending on the engine and environmental temperature. As soon as the idle speed keeps the engine running, it is advisable to disable the control.



Throttle twist grip

It controls the fuel-air mixture supplied to the engine, which regulates engine speed. To increase engine speed, rotate the hand grip from its idle position counterclockwise.

When cold starting (choke on), rotating the throttle twist grip clockwise fully causes the choke lever to return to its original position.

3

Front brake lever

It controls a hydraulic circuit that operates the front wheel braking system.

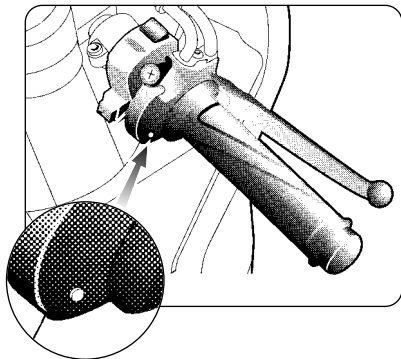

WARNING

In some countries, the laws in force impose the restriction of vehicles' engine power. Under these conditions, the throttle twist grip of your motorcycle must be equipped with the mechanical device shown in the picture on the left. This device must neither be removed nor tampered in any way. The removal or tampering of the above device leads to the following events:

- violation of the laws in force in the country in which you use your motorcycle;
- damage to the motorcycle;
- compromising of the safety conditions;
- loss of the warranty rights.



3.5. Ignition switch and steering lock

**WARNING**

Do not attach a ring or any other object to the ignition key as they may hinder the steering action.

**WARNING**

Never attempt to change the switch functions while riding, as you may lose control of the vehicle.

The ignition switch enables and disables the electrical circuit and the steering lock. The four positions of the switch are described below.

OFF position

All electrical circuits are deactivated. The key can be removed.

ON position

All electrical circuits are activated. The instruments and warning lights perform the self-diagnostic cycle. The engine can be started. The key cannot be removed.

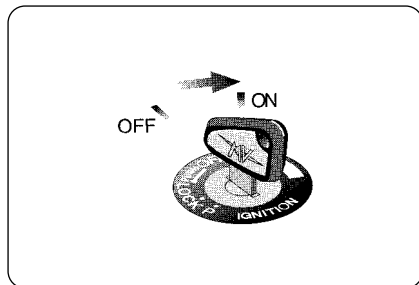
**CAUTION**

Do not leave the key on the ON position for a long time when the engine is not running, in order to avoid damage to the electrical parts of the motorcycle.



LOCK position

Turn the handlebar to the left or right. Press the key in gently while rotating it to the LOCK position.

All electrical circuits are deactivated and the steering is locked. The key can be removed.

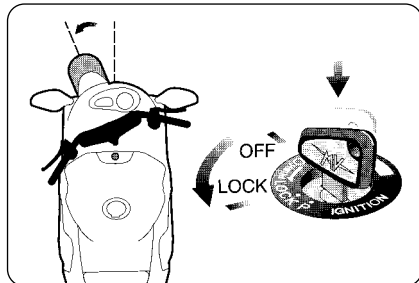

P (PARKING) position

Turn the key from the LOCK position to the P position. All electrical circuits are deactivated except the parking lights. The steering is locked. The key can be removed.



CAUTION

Do not leave the key on the P position for a long time, in order to avoid discharging the battery of your motorcycle.

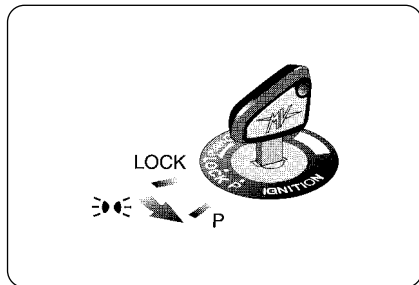



3.6. Gear lever

The **N** (neutral) position is indicated by the warning light on the instrument panel.

To change into first gear, push the lever down.

To change into second gear, lift the lever up. Lifting the lever up repeatedly engages all the other gears in succession up to the sixth speed.

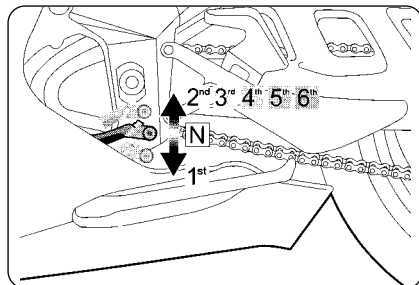



3.7. Instruments and warning lights

The instruments and warning lights are activated by turning the ignition switch to the ON position. After a preliminary check (approx. 7 seconds) the displayed information reflects the current general condition of the motorcycle.

3

Warning lights
(§3.7.1.)

SET button (§3.7.2.)

Multifunction display (§3.7.2.)

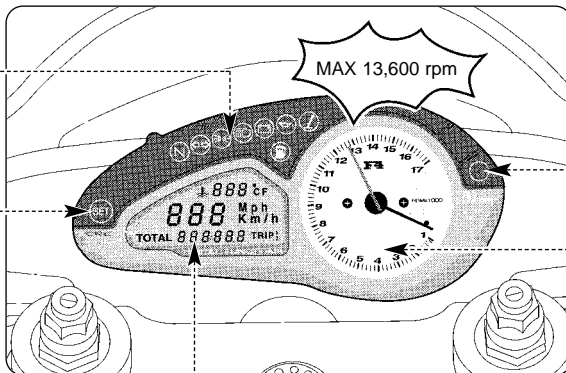

Warning light
(§3.7.1.)

Tachometer



3.7.1. Warning lights

High beam warning light (blue)

Lights up when the high beam is activated.

Battery charge indicator (red)

Lights up when the alternator does not supply enough current to charge the battery.

Low beam warning light (green)

Comes on when the low beam is activated.

If the indicator comes on while riding, contact an authorized service centre.

Sidestand down warning light (red)

Lights up when the sidestand is down.

Neutral indicator (green)

Lights up when the gears are in neutral.

Rev limiter warning light (red)

Lights up when the engine speed exceeds 13,600 rpm. The rev limiter limits the rpm to 13,900.

Turn indicator light (green)

Lights up when the turn indicators are activated.

Engine oil pressure warning light (red)

Lights up when the oil pressure is insufficient.

Reserve fuel indicator (amber)

Comes on when approximately 4 litres of fuel are left.

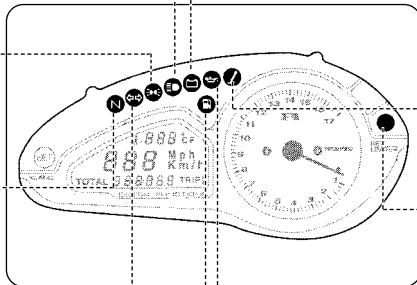

WARNING: If the warning light comes on while riding, stop the motorcycle immediately. Check and if necessary restore the oil level. If the warning light comes on even if the oil level is correct, do not resume riding and contact an authorized service centre.



3.7.2. Multifunction display

Speedometer

Measures the speed of the vehicle. The speed can be displayed in kilometres per hour (km/h) or miles per hour (mph). The full-scale value is 299 km/h (185 mph).

SET button

Pressing the button allows the setting of the different display functions. Pressing the button again confirms the entered values.

Pressing the SET button while pressing the engine start button activates the chronometer function.

TOTAL mileage counter

Displays the total distance covered: from 0 to 99,999.9 (km or mi)

TRIP 1 mileage counter

Displays a first trip mileage count: from 0 to 9,999.9 (km or mi)

TRIP 2 mileage counter

Displays a second trip mileage count: from 0 to 9,999.9 (km or mi)

Clock

Displays the time (0÷24)

Thermometer

Displays the coolant temperature in degrees centigrade (°C) or Fahrenheit (°F).

The display range is 40° to 140° C (104° to 284° F):

- Below 40° C (104° F) no temperature is displayed but three blinking lines denote a very low temperature.

- Between 40° and 49° C (104° and 120° F) the temperature reading blinks to indicate a low temperature.

- Between 50° and 105° C (122° and 221° F) the temperature reading is fixed.

- Between 106° and 140° C (223° and 284° F) the temperature reading blinks to indicate a high temperature.

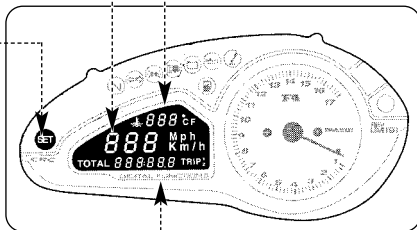

WARNING: If the temperature exceeds 120° C (248° F), stop the motorcycle immediately and check the coolant level. If the coolant level is low, carefully top up the coolant, after you have allowed the engine to thoroughly cool. Never attempt to remove the coolant filler cap when the engine is hot. If the high temperature indication is given even when the coolant level is correct, do not resume riding and contact an authorized service centre (see chapter 7 "Troubleshooting").



4.1. Using the motorcycle

This section provides the basic information needed to correctly operate the motorcycle:

- Running-in (§ 4.2.)
- Starting the engine (§ 4.3.)
- Selecting and setting the display functions (§ 4.4.)
- Refuelling (§ 4.5.)
- Glove compartment (§ 4.6.)
- Parking the motorcycle (§ 4.7.)
- Preriding checks (§ 4.8.)
- Riding (§ 4.9.)



WARNING: The F4 SPR motorcycle shows high power and performance characteristics; therefore, we suggest to correctly use the clutch operation device. In particular, taking into account the special transmission ratio of the first two gears, we strongly recommend not to perform abrupt and repeated standing starts with prolonged clutch skids. Under these conditions of use, the subsequent temperature increase would cause a fast decay of the clutch device, with subsequent loss of efficiency and serious malfunction.



Respect and defend natural environment

Everything we do affects the whole planet as well as its resources.

MV Agusta, in order to protect the interests of the community, awakens the Customers and the Technical Assistance operators to use the vehicle and dispose of its replaced parts respecting the laws in force concerning environmental pollution and waste disposal and recycling.



4.2 Running-in



CAUTION

Failure to observe the indications provided below can reduce performance and shorten the life of the motorcycle.

Running-in is generally considered to apply only to the engine. In fact, it should be regarded as an essential phase for other important parts such as the tyres, the brakes and the drive chain. During the very first miles, adopt a relaxed riding style.

4

□ 0 to 500 km (0 to 300 mi) (A)

Frequently change the engine speed. If possible, prefer hilly routes with gentle slopes and many bends. Avoid long straight stretches.

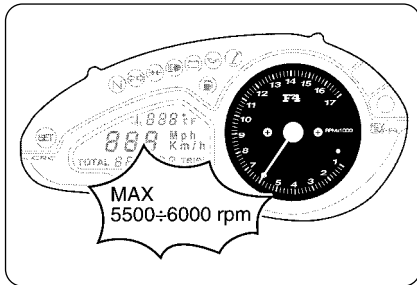

WARNING

New tyres must undergo a proper running-in period to reach their complete efficiency. Avoid abrupt acceleration, turning and braking during the first 100 km. Failure to observe these prescriptions can lead to the sliding of the wheels and the loss of control of the vehicle with subsequent risk of accidents.



❑ **500 to 1000 km (300 to 600 mi)**

Avoid lugging or overspeeding the engine, and vary your speed frequently.

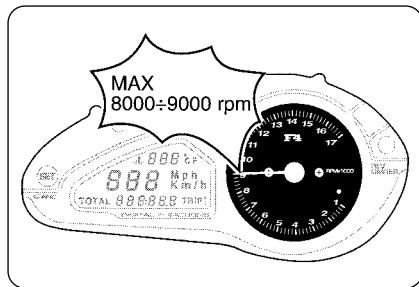

4

❑ **1000 to 2500 km (600 to 1600 mi)**

Higher engine performance can be demanded, but it is advisable not to exceed the engine speed shown in the figure.

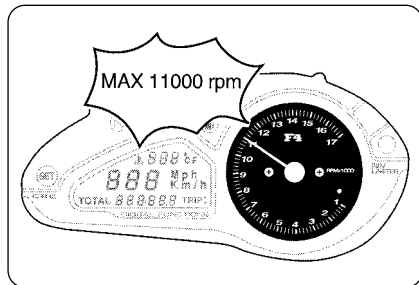



4.3. Starting the engine



WARNING

Starting the engine in a closed place can be dangerous. Exhaust emissions contain carbon monoxide, a colourless and odourless gas that can lead to serious harm or even death when inhaled.

Only start the engine outdoor, in the open air.

4

► As you turn the ignition switch to the ON position, the instruments and the warning lights will go through the self-diagnostic cycle; during this phase, make sure that all the warning lights on the dashboard come on. One of the following conditions must be verified, in order that the ignition switch system allows engine starting:

- The gears are in neutral.
- The gears are engaged, the clutch lever is pulled and the side stand is up.

Cold starting

► Rotate the CHOKE lever without turning the throttle twist grip and then press the start button.

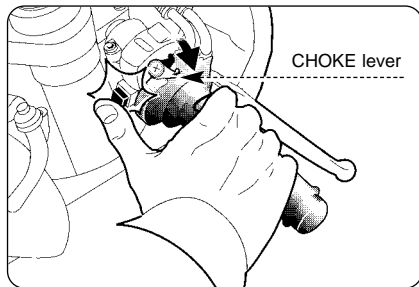



▶ As soon as the engine starts, release the button and, after warming up the engine for a short time, return the CHOKE lever to its original position.

❑ **Hot starting**

- ▶ Press the start button without turning the throttle twist grip.
- ▶ As soon as the engine starts, release the button.



CAUTION

- **Do not press the start button for longer than 5 consecutive seconds.**
- **Avoid warming up the engine while the vehicle is stationary. The subsequent engine overheating can cause damage to the internal parts of the engine. It is advisable to bring the engine to the working temperature by riding at reduced speed.**
- **To ensure the maximum life of the engine, never speed up at full throttle when the engine is cold.**

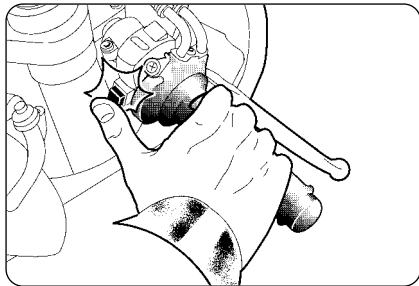



4.4. Selecting and setting the display functions

The multifunction display allows to change some of the main measuring parameters and to activate the chronometer function.

The main possible operations are the following:

- Selection of the display functions:
 - TOTAL Mileage Counter
 - TRIP 1 Mileage Counter
 - TRIP 2 Mileage Counter
 - Clock
 - Chronometer
- Setting the unit of the following quantities:
 - Speed
 - Mileage
 - Engine Oil Temperature
- Resetting the trip mileage counters:
 - TRIP 1 Mileage Counter
 - TRIP 2 Mileage Counter
- Setting the clock
- Activation of the chronometer function

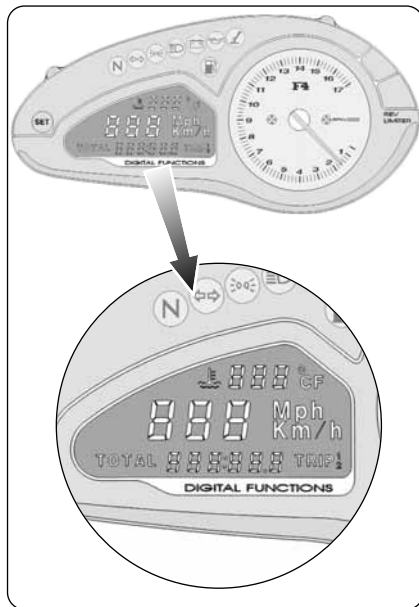



4.4.1. Selecting the display functions

You can select the following functions:

- TOTAL Mileage Counter
- TRIP 1 Mileage Counter
- TRIP 2 Mileage Counter
- Clock
- Chronometer

► The TOTAL, TRIP 1 and TRIP 2 functions can be displayed by pressing the engine start button. Pressing the button repeatedly cycles through the different functions. Select the desired function.

► The displaying of the chronometer function is shown in the following page.

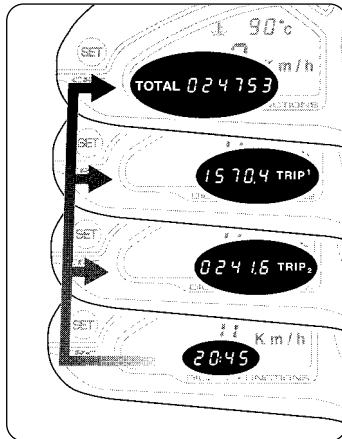

WARNING

The operation must be performed while the engine is running, the gears are in neutral, the motorcycle is stationary, and with the feet on the ground. Do not set the display functions while riding as it may cause loss of control of the vehicle.



□ Chronometer

► The chronometer function can be activated only when one of the following functions is selected:

- TOTAL Mileage Counter
- TRIP 1 Mileage Counter
- TRIP 2 Mileage Counter
- Clock

► Press the SET button and the engine start button at the same time for longer than 2 seconds.

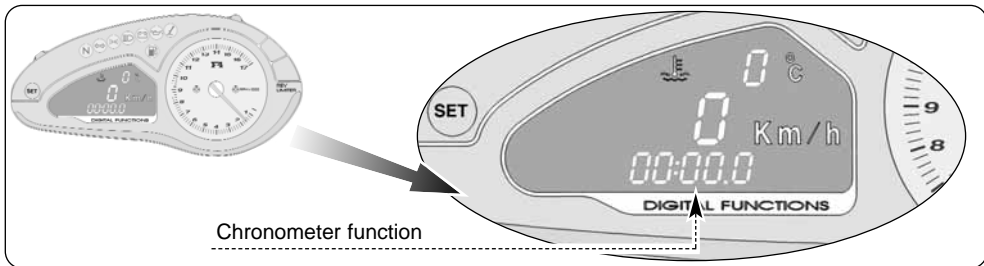
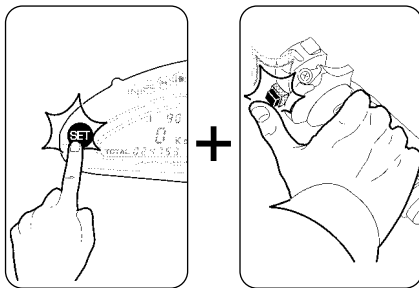

The chronometer function is explained in the following paragraphs (see § 4.4.5).



4.4.2. Setting the measurement units

It is possible to set the measurement units of the displayed quantities.



WARNING

The operation must be performed while the engine is running, the gears are in neutral, the motorcycle is stationary, and with the feet on the ground. Do not set the display functions while riding as it may cause loss of control of the vehicle.

□ Speedometer (Km/h - Mph)

- ▶ Repeatedly press the engine start button until the TOTAL mileage counter is displayed.
- ▶ Press the SET button; the speedometer unit starts blinking.

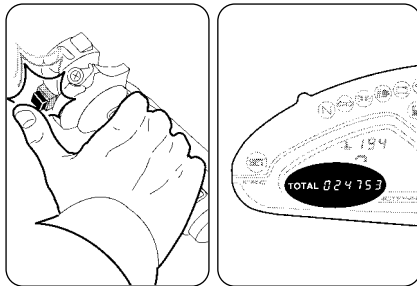

4

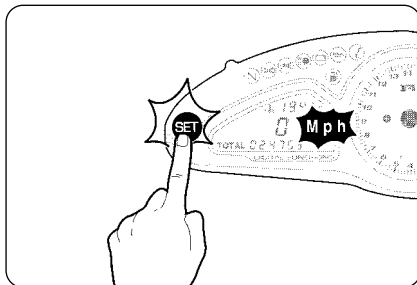



► Press the engine start button to toggle between Km/h and Mph. Changing the speedometer unit also changes the units for the total and trip mileage counters.

Remember that: 1 mi = 1,609 Km

4

► Press the SET button to confirm the speedometer unit. The thermometer unit will start blinking, indicating that the display is ready for the next setting.

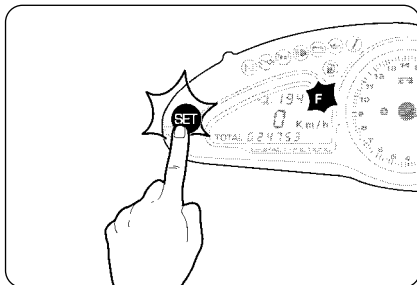
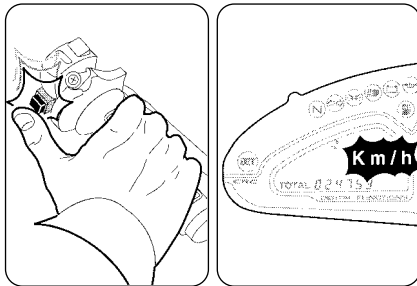



❑ Thermometer (° C - ° F)

- ▶ Press the engine start button to toggle between ° C and ° F.

Remember that: $T (^{\circ}\text{F}) = 1.8 \cdot t (^{\circ}\text{C}) + 32$

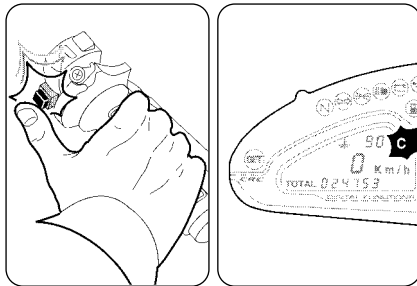

4

- ▶ Press SET to confirm the temperature unit.

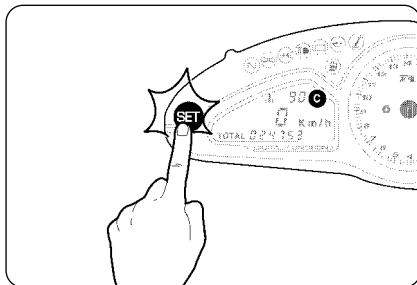



4.4.3. Resetting the trip mileage counters

The TRIP 1 and TRIP 2 counters can be reset as follows:



WARNING

The operation must be performed while the engine is running, the gears are in neutral, the motorcycle is stationary, and with the feet on the ground. Do not set the display functions while riding as it may cause loss of control of the vehicle.

- ▶ Select the TRIP 1 function by pressing the engine start button.
- ▶ Press the button for longer than four seconds. The TRIP 1 mileage will start blinking.

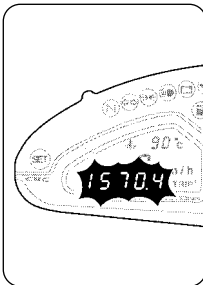
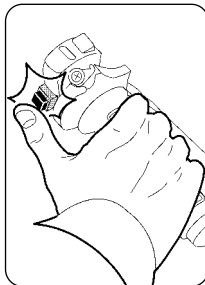
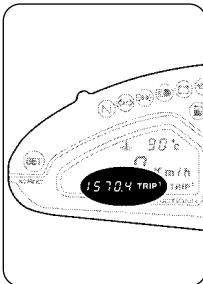
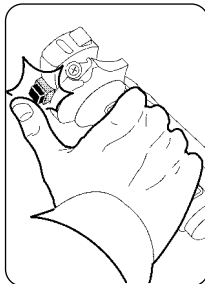



► Pressing the button for less than four seconds sets the mileage to zero. If, on the other hand, the button is pressed for longer than four seconds the entire resetting procedure is cancelled.

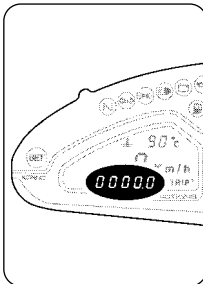
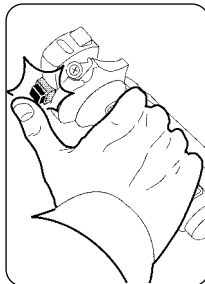

► Select the TRIP 2 function by pressing the engine start button.

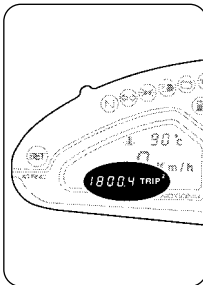
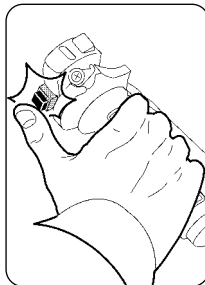



► Press the engine start button for longer than four seconds; the TRIP 2 mileage will start blinking.

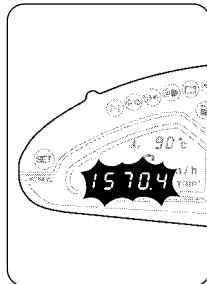
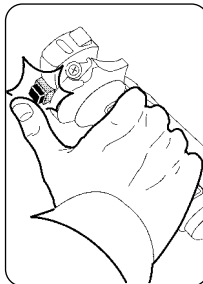

4

► Pressing the button for less than four seconds sets the mileage to zero. If, on the other hand, the button is pressed for longer than four seconds the entire resetting procedure is cancelled.

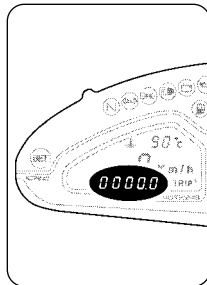
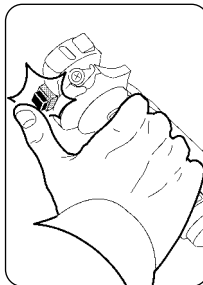



4.4.4. Setting the clock

It is possible to set the clock function.



WARNING

The operation must be performed while the engine is running, the gears are in neutral, the motorcycle is stationary, and with the feet on the ground. Do not set the display functions while riding as it may cause loss of control of the vehicle.

- ▶ Repeatedly press the engine start button until the time is displayed.
- ▶ Press the SET button – the first hour digit will start blinking.

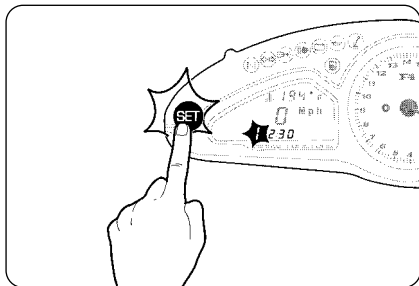
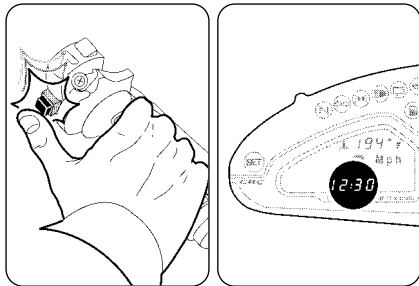



- ▶ Hold down the engine start button and release it as soon as the desired figure is displayed.

NOTE

To quickly cycle through the selected digit, hold the start button depressed for longer than two seconds.

- ▶ Press SET to confirm the first hour digit and to be able to set the following digit.
- ▶ Repeat the procedure to set the second hour digit and the first and second minute digits.
- ▶ Press SET to confirm the time and exit the set (blinking) mode.

NOTE

The instrument panel has an integrated memory which retains all the parameters even when the engine is not running. Except for the clock, which is reset, all the parameters are retained even when the battery is disconnected.

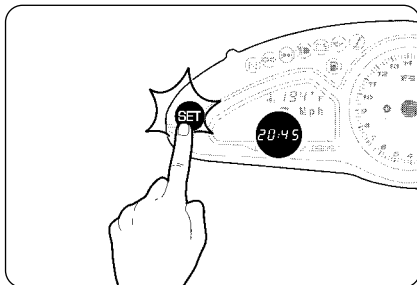
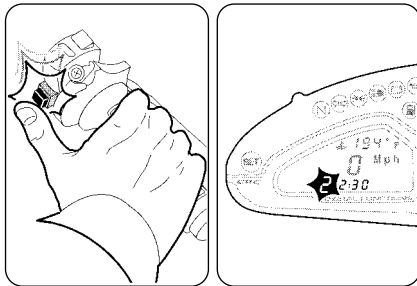



4.4.5. Chronometer

► The chronometer function can be activated only when one of the following functions is displayed:

- TOTAL Mileage Counter
- TRIP 1 Mileage Counter
- TRIP 2 Mileage Counter
- Clock

► Press the SET button and the engine start button at the same time for longer than 2 seconds. The chronometer function is activated. The digits “00:00.0” are displayed.



WARNING

The operation must be performed while the engine is running, the gears are in neutral, the motorcycle is stationary, and with the feet on the ground. Do not set the display functions while riding as it may cause loss of control of the vehicle.

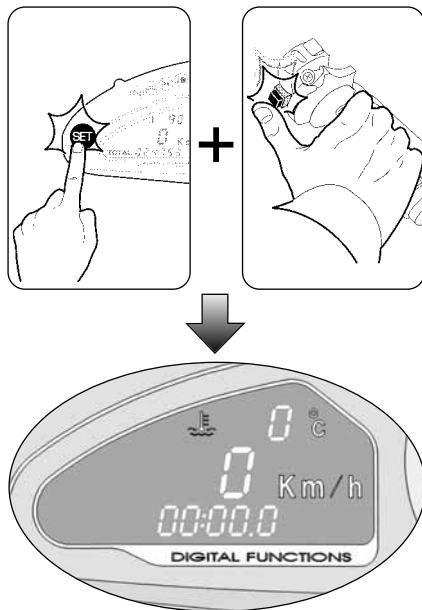



□ Lap Time Recording

After the chronometer function has been activated, it is possible to begin the data storing by pressing the high beam flasher button. Performing this operation starts the first lap time measurement.

The two points between the minutes and seconds digits will start blinking. The instrument will start measuring the first lap time.

4

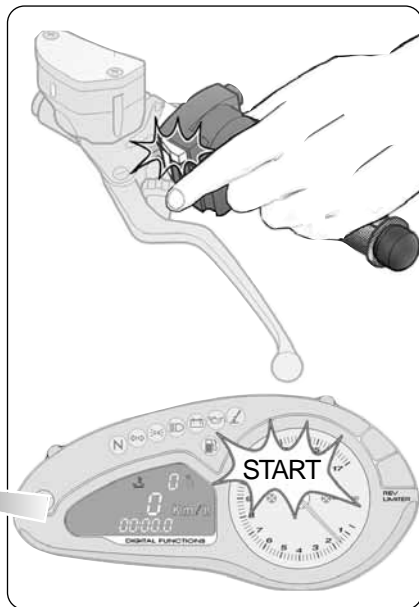
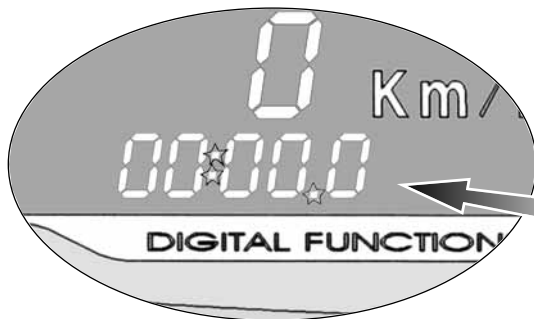



The first lap time is recorded by pressing the high beam flasher button again. At the same time, the instrument will start measuring the second lap time.

The first lap time is stored in the instrument memory, and it remains displayed until the next lap time is recorded.

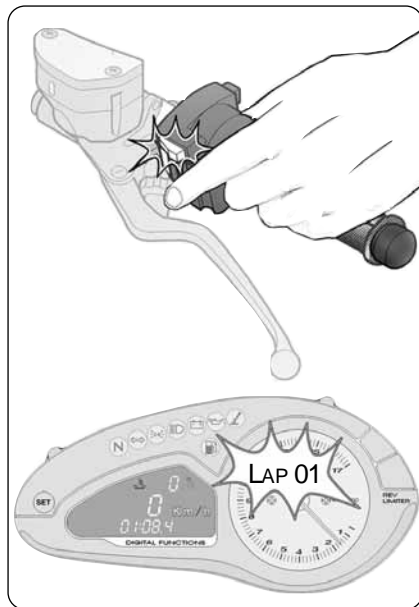



Repeating the above mentioned operations, you record one lap time every time you press the high beam button. The instrument can perform up to 80 consecutive recordings.

If the present lap time is lower than the previous one, the symbol “-” is displayed near the chronometer digits.

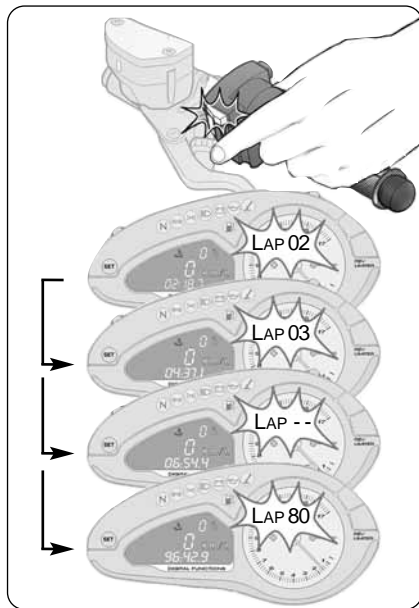
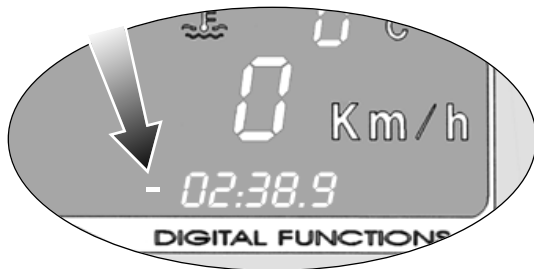



□ Lap Time Displaying

At the end of the lap time recording, it is possible to display the stored data.

NOTE

Make sure not to shut off the engine. This would cause the loss of all the stored data.

- ▶ Press the SET button for a time longer than 0.25 sec and less than 2 sec.

NOTE

Pressing the SET button for longer than 2 seconds would cause the loss of all the stored data.

- ▶ The “LAP 01” writing is displayed; after one second, the display shows the time corresponding to the first recorded lap.

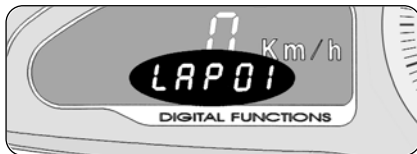
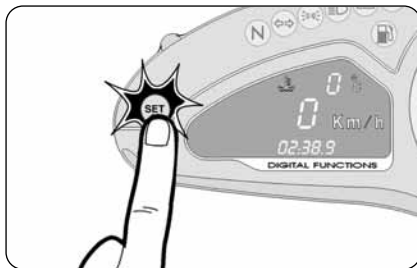



► The writing “LAP 02” is displayed by pressing the high beam flasher button; after one second, the display shows the time corresponding to the second recorded lap.

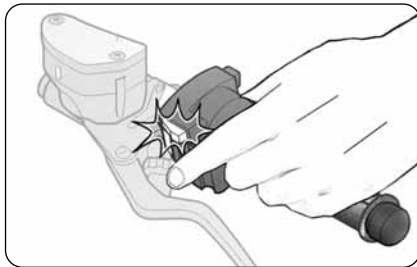

► Repeatedly pressing the high beam flasher button, the following lap times are displayed. After the last lap time has been displayed, the display shows the first lap data (“LAP 01”) by pressing the high beam button once more.

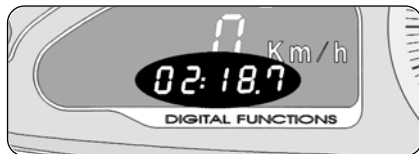



□ Fastest Lap Time Displaying

- ▶ Make sure that the display is on the lap time displaying mode, and that the first lap data are displayed ("LAP 01").
- ▶ Press the SET button for longer than 2 seconds.

NOTE

Pressing the SET button for less than 2 seconds would cause the exit from the lap time displaying mode.

- ▶ The number of the fastest lap is displayed; after one second, the display shows the corresponding fastest lap time.

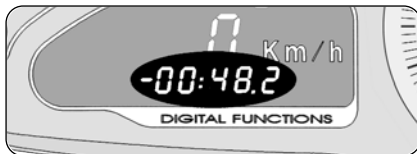
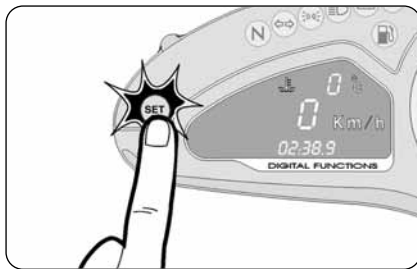



□ Return to the Lap Time Recording mode

▶ Pressing the SET button for longer than 0.25 sec and less than 2 sec, the display returns to the lap time recording mode. By now, you can continue your previous timing session or begin a new one.

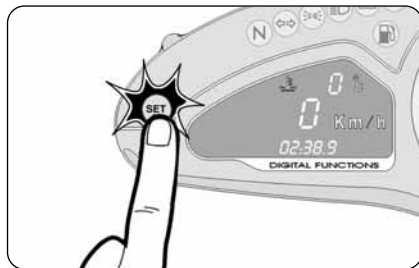

▶ The display shows the time corresponding to the last stored lap.

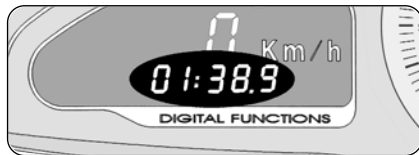

NOTE

When you return to the lap time recording mode, the digits “00:00.0” will be displayed if no lap time has been previously stored.

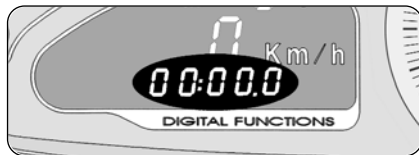



❑ Resetting the chronometer

You can reset the chronometer by pressing the SET button for longer than 2 seconds. This operation will cancel all the previously stored data from the instrument memory.

NOTE

Once you cancel the previously stored data, they cannot be retrieved.

Chronometer resetting can also be performed when the chronometer function is active. In this case, the timing session will be stopped.

After resetting the chronometer, the digits “00:00.0” will be displayed.

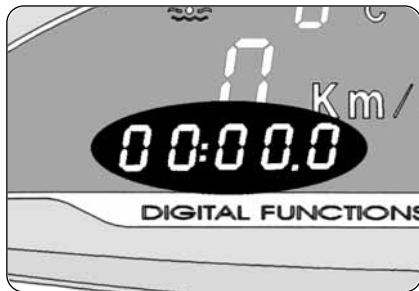
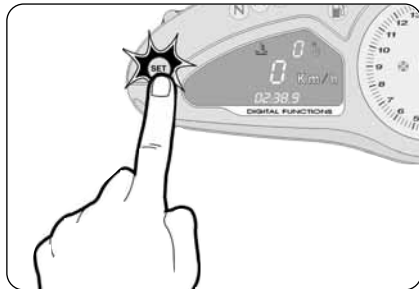



4.5. Refuelling



WARNING

Petrol and its fumes are highly toxic and flammable. Avoid contact and inhalation.

When refuelling, switch off the engine, avoid smoking, and keep away from flames, sparks and heat sources. Perform refuelling in the open air or in a well ventilated area.

4



CAUTION

Only use unleaded fuel with a R.O.N. octane rating of 95 or higher. The green dot on the lower side of the tank cap and the steering damper label upon the fuel tank serve as a reminder of this.

- ▶ Lift the dust cover.
- ▶ Insert the key into the lock, rotate it clockwise and lift the tank cap.
- ▶ After refuelling, press down the tank cap while rotating the key clockwise to facilitate the locking. Then release the key and remove it.

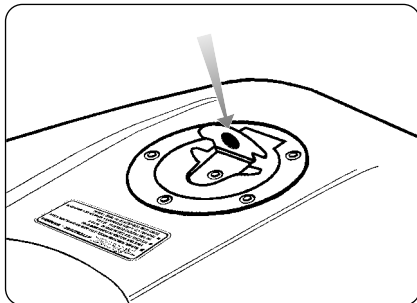
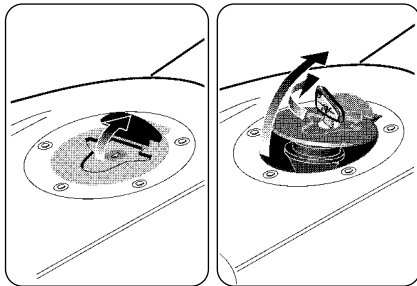

**WARNING**

Overfilling the tank may cause the fuel to overflow as a result of the expansion due to the heat from the engine or to exposure to sunlight. Fuel spills can catch fire. The level of the fuel in the tank must never be higher than the base of the filler.

**CAUTION**

Immediately wipe the overflowed fuel with a clean cloth, to avoid damage to the painted or plastic surfaces.

**WARNING**

Verify that the tank filler cap is correctly closed before using the motorcycle.

4.6. Glove compartment

- ▶ Insert the key into the lock.
- ▶ Press the rearmost portion of the tail section down while turning the key clockwise.
- ▶ Gently lift the tail section while gently pulling backwards. Fold the tail section up over the fuel tank.

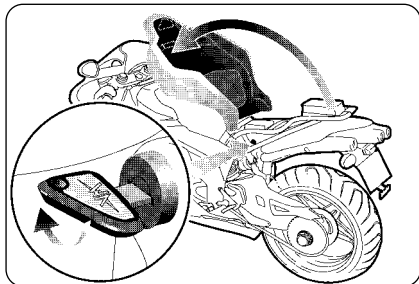



4.7. Parking the motorcycle

□ Using the sidestand



CAUTION

- Park the motorcycle safely on solid ground.
- On slopes, engage the first gear and park the vehicle so that the front wheel faces uphill. Remember to put the gear lever in the neutral position before restarting the engine.
- Never leave the vehicle unattended while the engine key is in the dashboard.

► Using your foot, lower the sidestand as far as it will go, and then slowly tip the motorcycle toward you to bring the stand supporting foot into contact with the ground's surface.

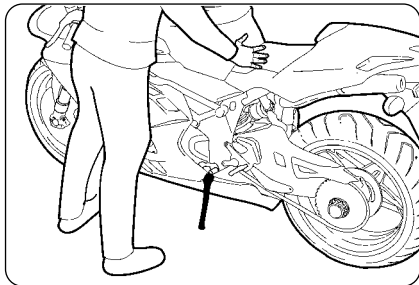

**WARNING**

Do not sit on the vehicle when it is parked on the sidestand, as your full weight would rest on the vehicle's only support.

**WARNING**

Before riding off, ensure that the sidestand warning light on the instrument panel goes out. In any case, make sure that the stand has been retracted. If you notice a malfunction of the side stand switch, have it controlled by your MV Agusta dealer before using the motorcycle.

□ Using the rear stand

Insert the stand pin into the rear wheel axle hole on the left side of the motorcycle. Rest the stand on the ground and, pressing down on the stand, lift the vehicle until it reaches a stable condition.

**CAUTION**

This operation is best carried out with two people, one to steady the motorcycle and one to manipulate the rear stand.

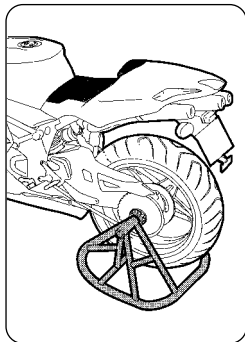
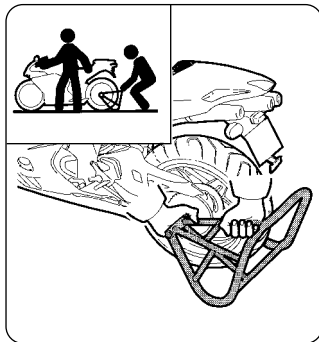



4.8. Preriding checks



WARNING

A motorcycle can be in good running order and then become unexpectedly unreliable even if unused (e.g. deflation of the tyres). It is therefore important to carry out the checks described in the table below before each ride. A few moments taken to carry out these checks will help you maintain your motorcycle safe and in perfect working order.

Brakes

Check fluid level (§ 6.8).

Check for fluid leakage.

Pull lever and press pedal to check brake operation.

Lubricate the lever joint, if necessary.

Check pads for wear (§ 6.7.)

Gear lever

Press pedal to check gear operation.

Lubricate the lever joint, if necessary.

Engine start button / stop switch

Check operation (§ 3.4).

Clutch lever

Check fluid level (§ 6.9).

Check for fluid leakage.

Pull lever and check that it moves smoothly and gradually.

Lubricate the lever joint, if necessary.

Throttle twist grip

Check that grip rotates smoothly and returns to closed position when released.

Steering system

Verify that the operation is smooth and uniform.

Check for play and loosening.

Steering damper

Check adjustment (§ 5.6).

Lights, visual and acoustic signals

Check operation.

Tyres

Check inflating pressure and wear (§ 6.10).

Suspensions

Verify that the operation is smooth and uniform.

Check adjustment (§ 5.7 and § 5.8).

Frame fasteners

Check tightening of all screws and nuts.

Tighten them, if necessary.

Drive chain

Check adjustment and lubrication (§ 6.11).

**Coolant**

Check level (§ 6.6).
Check for leakage.

Engine oil

Check level (§ 6.5).
Check for leakage.

Fuel

Check level.
Refuel, if necessary (§ 4.5).
Check for fuel leakage.

Sidestand

Check return to stowed position.

**WARNING**

If any of the above-mentioned parts shows a failure during its operation, have it controlled and repaired before using the motorcycle.



4.9. Riding

Riding a motorcycle requires experience and concentration.

Inexperienced riders should undergo a period of training and attend an introductory course consisting of theoretical lessons as well as practical riding sessions in areas closed to traffic.

The instructor's advice will help the novice rider become familiar with the basics of riding safety.

Relying on the advice of persons other than a qualified riding instructor, even if possessing specific knowledge, may prove to be useless or even dangerous, especially if the practical training takes place in an area open to traffic.

4

**WARNING**

While riding, always observe the safety prescriptions described in paragraph 2.1.7. of this manual.



5.1. List of adjustments

There are many adjustments that can significantly improve the ergonomics, geometry and safety of the motorcycle.

Some of these can only be performed by skilled personnel at authorized service centres.



WARNING

To avoid losing control of the vehicle while riding, be sure to always keep both hands on the handlebars. All adjustments must be performed when the vehicle is stationary.



(F) Rearview mirror adjustment (§ 5.5)

(A) Clutch lever adjustment (§ 5.4)

(F) Rearview mirror adjustment (§ 5.5)

(C) Right-hand footrest adjustment (§5.2.)

(E) Rear brake lever adjustment (§ 5.2)

(B) Front brake lever adjustment (§ 5.3)

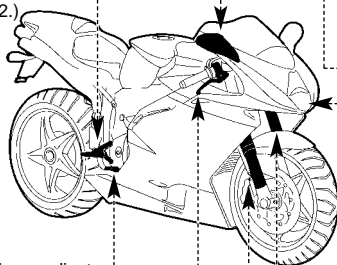

(G) Steering damper adjustment (§ 5.6)

(D) Gear lever adjustment (§ 5.2)

(L) Rear suspension adjustment (§ 5.8)

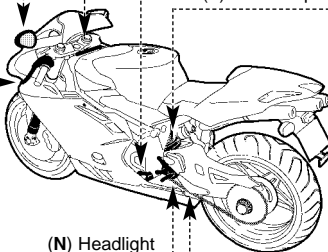

(N) Headlight adjustment (§ 5.2)

(M) Drive chain adjustment (§ 5.2)

(C) Left-hand footrest adjustment (§ 5.2)

(H) Front suspension adjustment (§ 5.7)



5.2. Table of adjustments

	A - Clutch lever adjustment: Optimizes the grip to suit the rider's needs (§ 5.4).		H - Front suspension adjustment: The following can be adjusted to adapt the response of the suspension to the rider's preference: <ul style="list-style-type: none">- spring preload (§ 5.7.1)- rebound damper (§ 5.7.2)- compression damper (§ 5.7.3)
	B - Front brake lever adjustment: Optimizes the grip to suit the rider's needs (§ 5.3).		L - Rear suspension adjustment: The following can be adjusted to adapt the response of the suspension to the rider's preference: <ul style="list-style-type: none">- spring preload- geometry height- rebound damper (§ 5.8.1)- high speed compression damper (§ 5.8.2)- low speed compression damper (§ 5.8.3)
	C - LH and RH footrest adjustment: Optimizes the position of the footrests to suit the rider's needs.		M - Drive chain adjustment: To ensure safe and effective transmission of power.
	D - Gear lever adjustment: Optimizes the position of the lever to suit the rider's needs.		N - Headlight adjustment: To adjust the range of the light beam to the geometry of the motorcycle.
	E - Rear brake lever adjustment: Optimizes the position of the lever to suit the rider's needs.		
	F - Rearview mirror adjustment: Optimizes the orientation of the rearview mirrors (§ 5.5).		
	G - Steering damper adjustment: Adjusts the steering stiffness to the rider's preference (§ 5.6).		



5.3. Adjusting the front brake lever



WARNING

Never perform the adjustment while riding.

While pulling the lever to counter the action of the spring, turn the ring clockwise or counterclockwise to move the lever away or towards the hand-grip respectively.

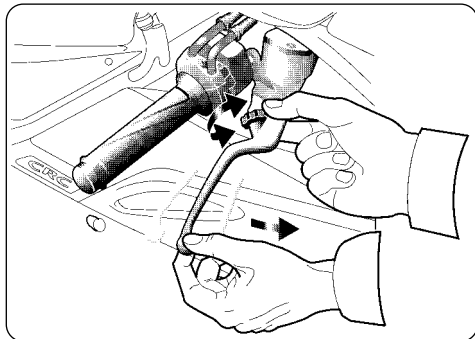

5.4. Adjusting the clutch lever



WARNING

Never perform the adjustment while riding.

While pulling the lever to counter the action of the spring, turn the ring clockwise or counterclockwise to move the lever away or towards the hand-grip respectively.

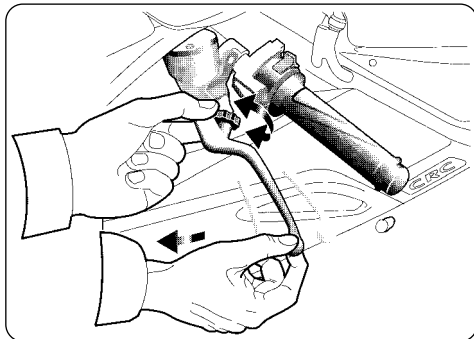



5.5. Adjusting the rearview mirrors

**WARNING**

Never perform the adjustment while riding.

Press the mirror at the points shown in the figure to adjust its position in the four directions.

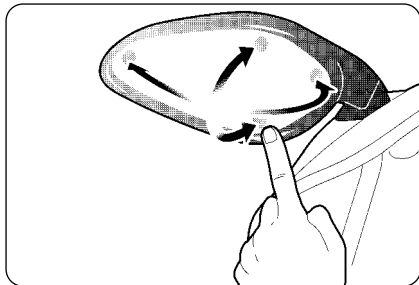

5.6. Adjusting the steering damper

**WARNING**

Never perform the adjustment while riding.

The standard adjustment is obtained by fully rotating the knob counterclockwise. In this position the damper offers the least resistance to the rotation of the steering. To suit the rider's needs, the action of the damper can be gradually increased by rotating the knob clockwise.

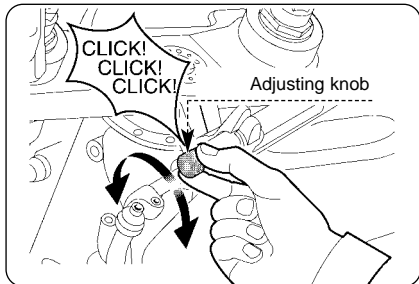



5.7. Adjusting the front suspension

**WARNING**

It is essential that the adjusters of both fork rods are adjusted to the same position.

	Type of geometry		
	Soft	Standard	Stiff
Spring preload	3 turns	5 turns	7 turns
Rebound damping	14 clicks	10 clicks	7 clicks
Compression damping	12 clicks	8 clicks	5 clicks

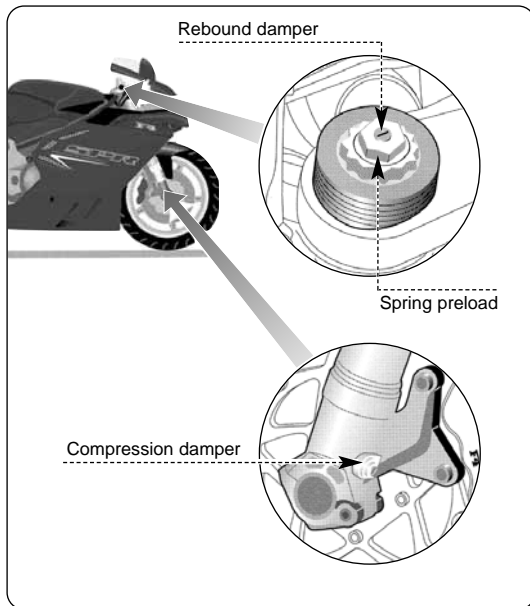



5.7.1. Spring preload

The adjustment is obtained from the standard position, which is found by fully turning the adjusting nut counterclockwise and then clockwise (see table). Rotate clockwise to increase the spring preload or counterclockwise to decrease it.

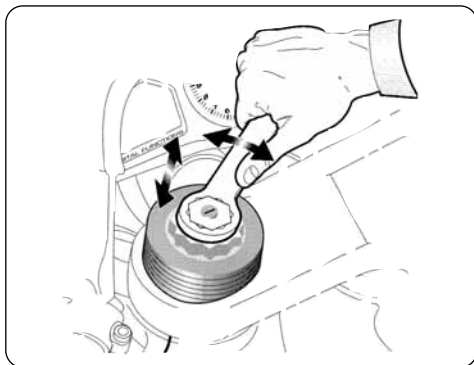

5.7.2. Rebound damper (front suspension)

The adjustment is obtained from the standard position, which is found by fully turning the screw clockwise and then counterclockwise (see table). Rotate clockwise to increase the damping action or counterclockwise to decrease it.

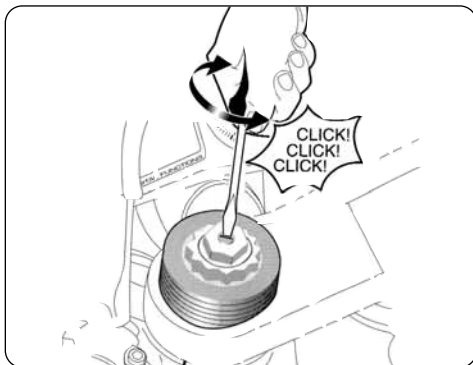



5.7.3. Compression damper (front suspension)

The adjustment is obtained from the standard position, which is found by fully turning the screw clockwise and then counterclockwise (see table). Rotate clockwise to increase the damping action or counterclockwise to decrease it.

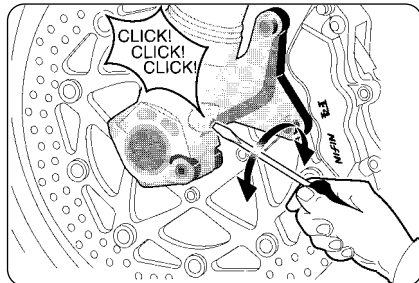

5.8. Adjusting the rear suspension



CAUTION

When you estimate the rear suspension settings, never push or pull in any way on the exhaust mufflers. They would be certainly damaged.

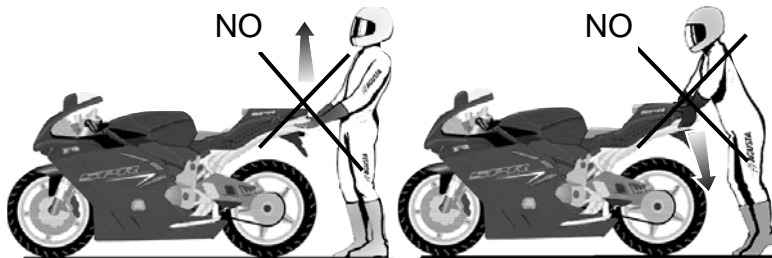



WARNING: The high temperature of the exhaust pipes can cause burns. Before adjusting the rear suspension, shut off the engine and wait until the exhaust pipes have thoroughly cooled.



WARNING: The rear shock absorber contains highly compressed gas. Do not try to open or disassemble it in any way.

NOTE: At the moment of delivery of the motorcycle, the rear suspension is adjusted in the standard configuration (see enclosed table).

	Type of geometry		
	Soft	Standard	Stiff
Rebound damper (§5.8.1.)	24 clicks	20 clicks	16 clicks
High speed compression damper (§5.8.2.)	0 clicks	0 clicks	up to 6 clicks
Low speed compression damper (§5.8.3.)	18 clicks	15 clicks	12 clicks

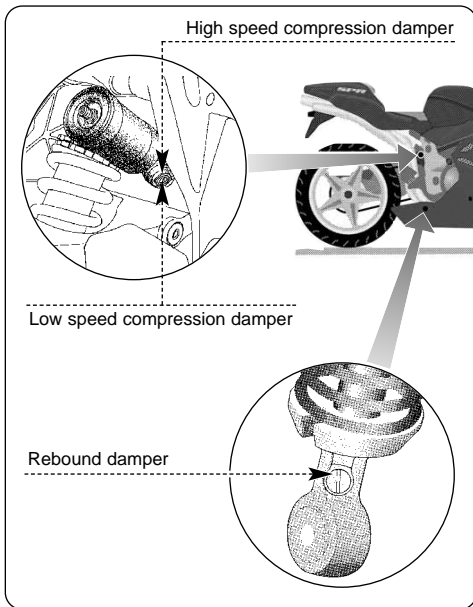



5.8.1. Rebound damper (rear suspension)

The adjustment is obtained from the standard position, which is found by fully rotating the ring clockwise and then counterclockwise (see table). Rotate clockwise to increase the damping action or counterclockwise to decrease it.

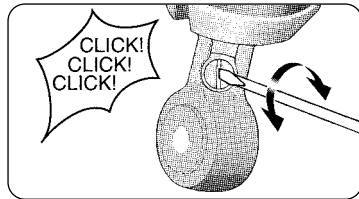

5.8.2. High speed compression damper (rear suspension)

The adjustment is obtained from the standard position, which is found by fully rotating the screw counterclockwise and then clockwise (see table). Rotate clockwise to increase the damping action or counterclockwise to decrease it.

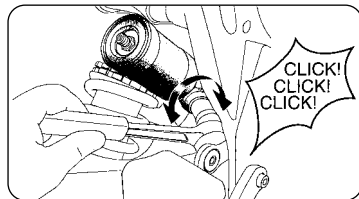

5.8.3. Low speed compression damper (rear suspension)

The adjustment is obtained from the standard position, which is found by fully rotating the screw clockwise and then counterclockwise (see table). Rotate clockwise to increase the damping action or counterclockwise to decrease it.

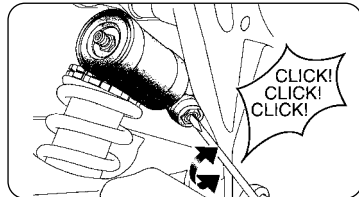



5.9. Headlight adjustment

Place the vehicle at a distance of 10 m from a vertical wall.

Make sure that the motorcycle is placed on an even horizontal surface, and that the headlight's optical axis is perpendicular to the wall.

The vehicle must be held in an upright position. Measure the "X" distance between the headlight center and the ground surface, then trace a small cross on the wall at the same height.

When you turn the headlight on, the upper boundary line between the dark area and the lighted area must be at an height equal or lower than the 9/10 of the headlight center height (X).

For the adjustment of the headlight, the possible adjustment range is : $\pm 4^\circ$.

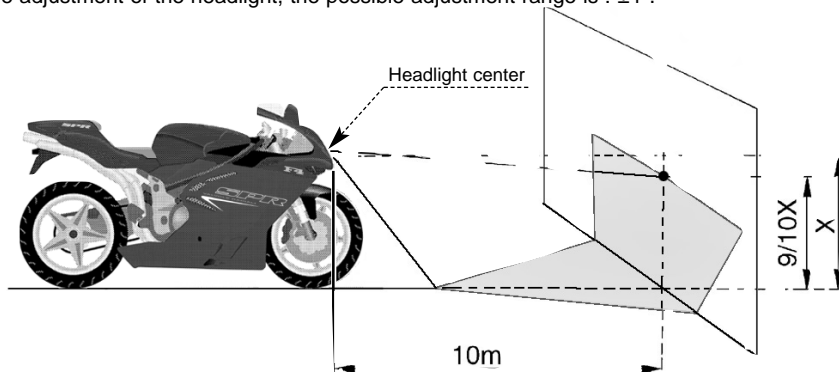



6.1. Tables of scheduled maintenance and checks

The main periodic checks and maintenance operations are shown in the following tables. These operations are necessary to keep the motorcycle safe and in perfect running order.

The intervals indicated in the periodic maintenance and lubrication tables must be intended as a general guide under normal riding conditions. It could be necessary to reduce these intervals according to the climate, the ground conditions, the geographic position and the conditions of use.

Some of the operations can be carried out by the user, providing he or she possesses the requisite skills. If unskilled, have the operations performed by an authorized service centre.

6

As a rule maintenance operations must be performed while the motorcycle is on the rear stand after switching off the engine and setting the start switch to OFF. On the contrary, while checking the fluid levels it is advisable to keep the motorcycle in an upright position without using the rear stand.

After the first 36,000 km (22,400 mi) the operations must be performed at the same intervals shown in the tables.

**WARNING**

- Improprity or lack of recommended manitenance operations can lead to an increase of the risk of accidents and damage to the motorcycle.
- Always use genuine MV Agusta spare parts. Using non-genuine spare parts can accelera-te the wear of your motorcycle and shorten its life.
- Failure to perform the recommended operations, as well as using non-genuine spare parts, makes the warranty null and void.

**WARNING**

If yor motorcycle is involved in an accident, have all its main parts controlled by an autho-rized MV Agusta dealer. If necessary, you can make some provisional repairs by yourself.

**WARNING**

To replace or top up the lubricants and fluids of your motorcycle, use only the products given at paragraph 6.3.

**Respect and defend natural environment**

Everything we do affects the whole planet as well as its resources.

MV Agusta, in order to protect the interests of the community, awakens the Customers and the Technical Assistance opera-tors to use the vehicle and dispose of its replaced parts respecting the laws in force concerning environmental pollution and waste disposal and recycling.











Tables of scheduled maintenance

km (mi) covered		0	1000 (600)	6000 (3800)	12000 (7500)	18000 (11200)	24000 (14900)	30000 (18600)	36000 (22400)
Service coupon		Pre-delivery	A	B	C	D	E	F	G
DESCRIPTION		OPERATION							
Engine oil		Check level	Every time vehicle is used						
		Renew	●	●	●	●	●	●	●
			At least once a year						
Engine oil filter		Replace (Use only MV Agusta genuine spare parts)	●	●	●	●	●	●	●
			Every time engine oil is changed						
Coolant		Check / Restore level	Every time vehicle is used						
		Check / Restore level	●	●	●	●	●	●	●
		Renew	At least every two years						
Cooling system		Check for leakage	●	●	●	●	●	●	●
Electric fans		Check operation	●	●	●	●	●	●	●
Valves		Check / Adjust	●		●		●		●
Timing chain		Check	●		●		●		
		Replace							●



Tables of scheduled maintenance

km (mi) covered		0	1000 (600)	6000 (3800)	12000 (7500)	18000 (11200)	24000 (14900)	30000 (18600)	36000 (22400)	
Service coupon		Pre-delivery	A	B	C	D	E	F	G	
DESCRIPTION		OPERATION								
Timing movable shoe		Check / Replace	●		●		●			
		Replace							●	
		Every time timing chain is replaced								
Timing chain stretcher		Check / Replace			●		●		●	
Spark plugs		Check / Replace	●	●		●		●		
		Replace			●		●		●	
Fuel filter		Check / Replace			●		●		●	
Throttle body 		Check and Adjust	●	●	●	●	●	●	●	
Air filter		Check / Replace		●	●	●	●	●	●	
Brakes / Clutch fluid		Check level	Every time vehicle is used							
		Check level	●	●	●	●	●		●	●
		Renew					●			
		At least every two years								













Tables of scheduled maintenance

km (mi) covered		0	1000 (600)	6000 (3800)	12000 (7500)	18000 (11200)	24000 (14900)	30000 (18600)	36000 (22400)
Service coupon		Pre-delivery	A	B	C	D	E	F	G
DESCRIPTION		OPERATION							
Brakes / Clutch		Check operation	Every time vehicle is used						
		Check operation	●	●	●	●	●	●	●
		Check lines for leakage	●	●	●	●	●	●	●
Brake pads (front and rear)		Check wear	Every 1000 Km (600 mi)						
		Check / Replace		●	●	●	●	●	●
Fuel lines and connections		Check for leakage		●	●	●	●	●	●
		Replace	At least every 3 years						
Throttle control		Check operation	Every time vehicle is used						
		Check operation	●	●	●	●	●	●	●
		Check / Adjust play	●	●	●	●	●	●	●
Choke control		Check operation	●	●	●	●	●	●	●
Flexible controls and transmissions		Check / Adjust	●	●	●	●	●	●	●















Tables of scheduled maintenance

km (mi) covered		0	1000 (600)	6000 (3800)	12000 (7500)	18000 (11200)	24000 (14900)	30000 (18600)	36000 (22400)	
Service coupon		Pre-delivery	A	B	C	D	E	F	G	
DESCRIPTION		OPERATION								
Drive chain 		Check	Every 1000 Km (600 mi)							
		Lubricate	Every 1000 Km (600 mi) and after riding under the rain							
		Check / Adjust	●	●	●	●	●	●	●	●
		Lubricate		●						
		Replace			●	●	●	●	●	●
Front sprocket / Tab washer 		Check		●						
		Replace			●	●	●	●	●	●
			Every time drive chain is replaced							
Rear sprocket 		Check		●						
		Replace			●	●	●	●	●	●
			Every time drive chain is replaced							
Rear sprocket spring drive 		Check			●	●	●	●	●	
Steering head tube ring 		Check / Adjust		●		●		●	●	



Tables of scheduled maintenance

km (mi) covered		0	1000 (600)	6000 (3800)	12000 (7500)	18000 (11200)	24000 (14900)	30000 (18600)	36000 (22400)	
Service coupon		Pre-delivery	A	B	C	D	E	F	G	
DESCRIPTION		OPERATION								
Steering bearings 		Check / Adjust		●		●		●		●
		Lubricate						●		
Tyres		Check pressure	Every time vehicle is used; at least every 10 days							
		Check wear	Every time vehicle is used; at least every 500 Km (300 mi)							
		Check pressure	●	●	●	●	●	●	●	●
		Check wear		●	●	●	●	●	●	●
Wheel rims		Inspect visually		●	●	●	●	●	●	●
			Every time tyre is replaced							
Front wheel bearings 		Check		●	●	●	●	●		
		Every time tyre is replaced								
Sidestand		Check operation	Every time vehicle is used							
		Check operation	●	●	●	●	●	●	●	●



Tables of scheduled maintenance

km (mi) covered		0	1000 (600)	6000 (3800)	12000 (7500)	18000 (11200)	24000 (14900)	30000 (18600)	36000 (22400)
Service coupon		Pre-delivery	A	B	C	D	E	F	G
DESCRIPTION		OPERATION							
Side stand switch		Check operation	Every time vehicle is used						
		Check operation	●	●	●	●	●	●	●
Rear wheel hub		Check / Lubricate needle bearing			●		●		
		Replace / Lubricate needle bearing							●
Swingarm bearings		Check / Lubricate							●
Drive chain pads on swingarm		Check / Replace		●	●	●	●	●	●
Drive chain pads on frame plate		Check / Replace		●	●	●	●	●	●
Rear shock absorber		Check / Adjust		●		●		●	●
Front fork oil		Renew					●		
Battery connections		Check and clean		●	●	●	●	●	●
Electrical equipment		Check operation	●	●	●	●	●	●	●
Instrument panel		Check operation	Every time vehicle is used						
		Check operation	●	●	●	●	●	●	●



Tables of scheduled maintenance

km (mi) covered		0	1000 (600)	6000 (3800)	12000 (7500)	18000 (11200)	24000 (14900)	30000 (18600)	36000 (22400)
Service coupon		Pre-delivery	A	B	C	D	E	F	G
DESCRIPTION		OPERATION							
Lights / Visual signals		Check operation	Every time vehicle is used						
		Check operation	●	●	●	●	●	●	●
Horn		Check operation	Every time vehicle is used						
		Check operation	●	●	●	●	●	●	●
Headlight		Check operation	Every time vehicle is used						
		Check operation	●	●	●	●	●	●	●
		Adjust	Every time geometry is changed						
Ignition switch		Check operation	Every time vehicle is used						
		Check operation	●	●	●	●	●	●	●
Locks		Check operation	Every time vehicle is used						
		Check operation	●	●	●	●	●	●	●
Screws and nuts		Check / Tighten	●	●	●	●	●	●	●
Hose clamps		Check / Tighten	●	●	●	●	●	●	●



Tables of scheduled maintenance

km (mi) covered		0	1000 (600)	6000 (3800)	12000 (7500)	18000 (11200)	24000 (14900)	30000 (18600)	36000 (22400)
Service coupon		Pre-delivery	A	B	C	D	E	F	G
DESCRIPTION		OPERATION							
General lubrication			●	●	●	●	●	●	●
General test			●	●	●	●	●	●	●

In order to highlight symbols importance, remember the following information (already provided at § 1.2 of this manual):



Information on operations that can be carried out by the user.



Information on operations that **must** be performed **only** by your authorized MV Agusta dealer.



The “ ” symbol points out the requirement to use a tool or a special equipment in order to correctly perform the described operation.



The “ § ” symbol refers the reader to the chapter identified by the number that follows.



6.2. Tools and accessories supplied

A bag in the glove compartment contains the following tools:

- 1 hexagonal bar (10 mm hexagon);
- 6 Allen keys (2,5 - 3 - 4 - 5 - 6 - 8 mm hexagons);
- 1 spanner for rear wheel eccentric with extension;
- 2 fuses (7.5 A and 15 A).

The following accessories are also supplied:

- 1 rear stand;
- 1 rear sprocket for drive chain (number of teeth Z=37);
- 1 rear sprocket for drive chain (number of teeth Z=39);
- 1 spark plug wrench (16 mm hexagon);
- 1 motorcycle canvas cover;
- 2 handgrip covers;
- 1 document holder.

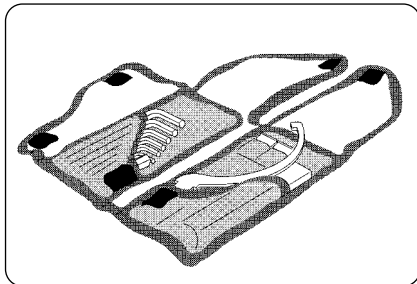

WARNING

The rear sprockets with Z=37 and Z=39 have been expressly designed for a specially competitive use of the vehicle. Their use is strictly limited to areas closed to traffic. Failure to observe this restriction constitutes a breach of the Highway Code, for which MV Agusta cannot be held responsible.



6.3. Table of lubricants and fluids

Description	Recommended product	Specifications
Engine lubrication oil	AGIP RACING 4T 10W/60 (*)	SAE 10W/60 - API SJ
Coolant	AGIP ECO - PERMANENT	Ethylene glycol diluted with 40 percent distilled water
Brake and clutch fluid	AGIP BRAKE FLUID DOT4	DOT4
Drive chain lubrication oil	AGIP CHAIN AND DRIVE SPRAY	–

* : MV Agusta suggests to refer directly to its authorized dealers in order to purchase the recommended product. The AGIP Racing 4T 10W/60 engine oil has been expressly produced for the F4 motorcycle engine. If the above described lubricant is not available, MV Agusta suggests to use a fully synthetic engine oil having characteristics equal or better than the ones prescribed in the following standards:

- Consistent with: API SJ
- Consistent with: ACEA A3
- Consistent with: JASO MA
- SAE Rating: SAE 20 W-50 or 10 W-60

NOTE

The above standard denominations must be written, alone or together, on the engine oil container label.





6.4. Removing/fitting the right-hand side fairing

Pull off the quick fastenings and then remove the side fairing.

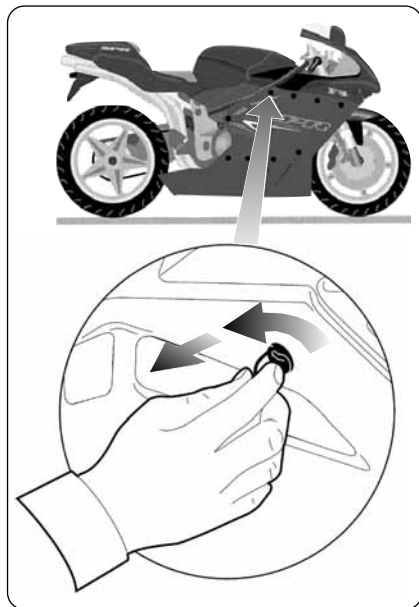

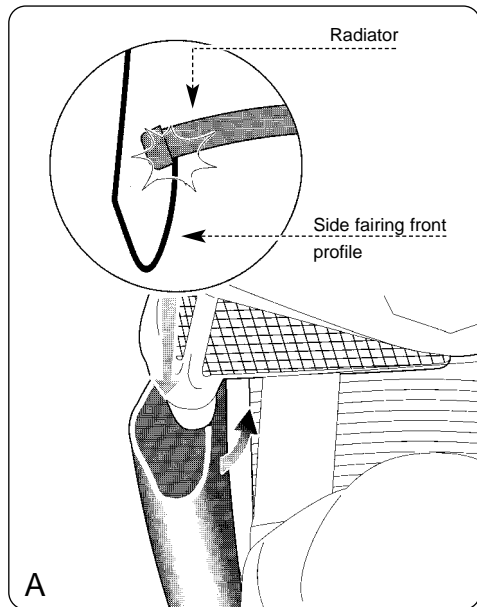

Fit the side fairing, taking care to position the front profile as shown in figure A.
Fasten the panel by positioning the tab in the lower part of the fairing as shown in figure B.

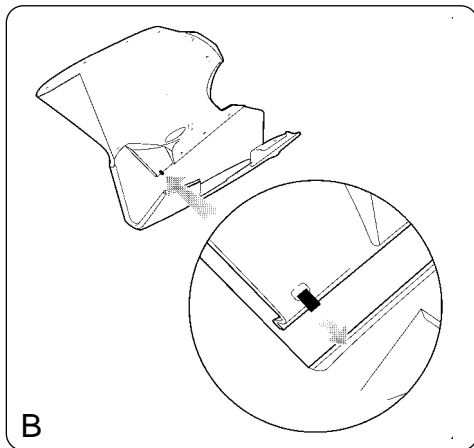



6.5. Checking the engine oil level

Check the oil level while the engine is not running, and has been allowed to cool down for at least ten minutes after a ride.

The check must be performed after placing the motorcycle in an upright position on a horizontal surface.

The level must be between the MAX and MIN marks on the crankcase.

If the oil level is below the MIN mark, top up as described in § 6.5.1.



WARNING

Do not start the engine if the oil level is below the MIN mark.

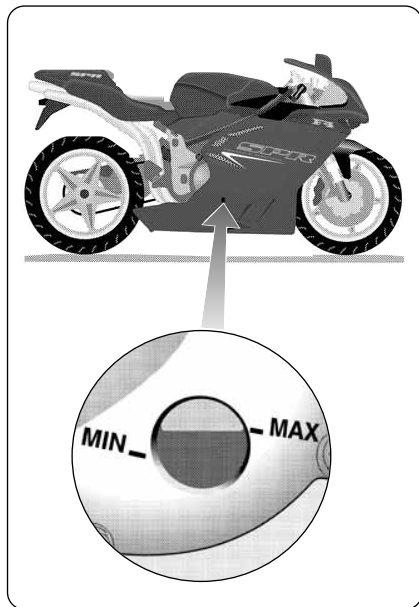



6.5.1. Topping up the engine oil level

To top up the engine oil level, first remove the right-hand side fairing (see § 6.4) to expose the oil filler plug. Remove the oil filler plug and pour an appropriate amount of engine oil of the recommended type (see § 6.3). Never exceed the MAX level mark.

At the end of the operation, place back the oil filler plug and reassemble the right-hand side fairing.

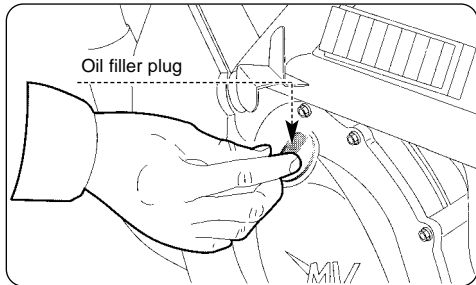

CAUTION

To avoid clutch sliding and damage to the engine, never add chemical additives to the engine oil, nor use an engine oil different from the one specified in the table at § 6.3. Make sure that no foreign body gets in the crankcase while topping up the engine oil.

**WARNING**

New or exhaust engine oil can be dangerous. Engine oil is highly toxic for people and domestic animals. Avoid ingestion and contact. In the event of an engine oil ingestion, immediately call a doctor and do not cause vomiting, in order to avoid inhalation of engine oil in lungs. It has been proved that prolonged contact with engine oil can cause skin cancer on guinea pigs. Even a brief contact with engine oil can cause skin irritation.

- Keep new or exhaust engine oil out of reach of children and domestic animals.
- While topping up the engine oil, wear a long-sleeved shirt and a pair of waterproof gloves to protect your skin.
- If the engine oil comes in touch with your skin, wash it away with soap and water.
- Correctly recycle or dispose of the exhaust engine oil, in order to avoid environmental pollution.



6.6. Checking the coolant level

Check the coolant level while the engine is off and cold.

The check must be performed after placing the motorcycle in an upright position on a horizontal surface.

Ensure that the coolant level is between the MIN mark and the lower side of the frame tube as shown in the figure.

If the coolant level is below the MIN mark, top up the coolant as described at paragraph 6.6.1.



WARNING

Do not start the engine if the coolant level is below the MIN mark.

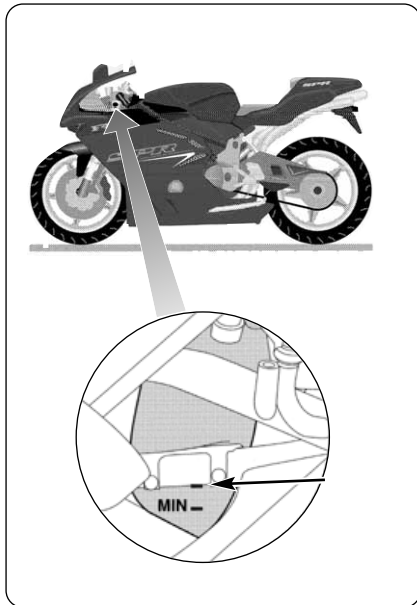



6.6.1. Topping up the coolant level

To gain access to the coolant filler cap, remove the left steering damper screw and the cover.

Remove the coolant filler cap and top up with the recommended coolant (see §6.3).



WARNING

Perform the topping up of the coolant when the engine is off and cold. Never attempt to remove the coolant filler cap when the engine is hot, in order to avoid the risk of burns. The cooling system is under pressure!

After topping up, carefully replace the previously removed parts.

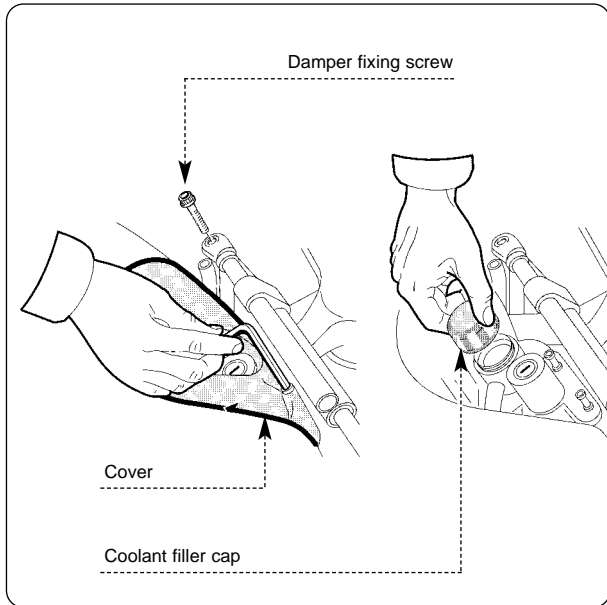

**WARNING**

Under certain conditions, ethylene glycol contained in the coolant can become flammable. When it is lighted, it produces an invisible flame.

Avoid spilling coolant on hot parts of the motorcycle, because the subsequent combustion of ethylene glycol could cause serious burns.

**WARNING**

Coolant is a highly toxic fluid. Avoid contact and ingestion. Keep coolant out of reach of children and domestic animals. In the event of a coolant ingestion, immediately call a doctor and do not cause vomiting, in order to avoid inhalation of coolant in lungs. If the coolant comes in touch with your skin or eyes, immediately wash it away with water.

**CAUTION**

To top up the coolant level and/or renew the coolant, use only the product specified in the table in section 6.3. Do not mix nor dilute the coolant with additives or different fluids. If the coolant specified in section 6.3. is not available, use a coolant having technical characteristics consistent with the prescribed product.

**CAUTION**

Coolant can damage painted and plastic parts. When you top up the coolant level, be careful not to spill coolant on any part of the motorcycle. If you do spill coolant on your motorcycle, immediately wipe it away using a clean cloth.

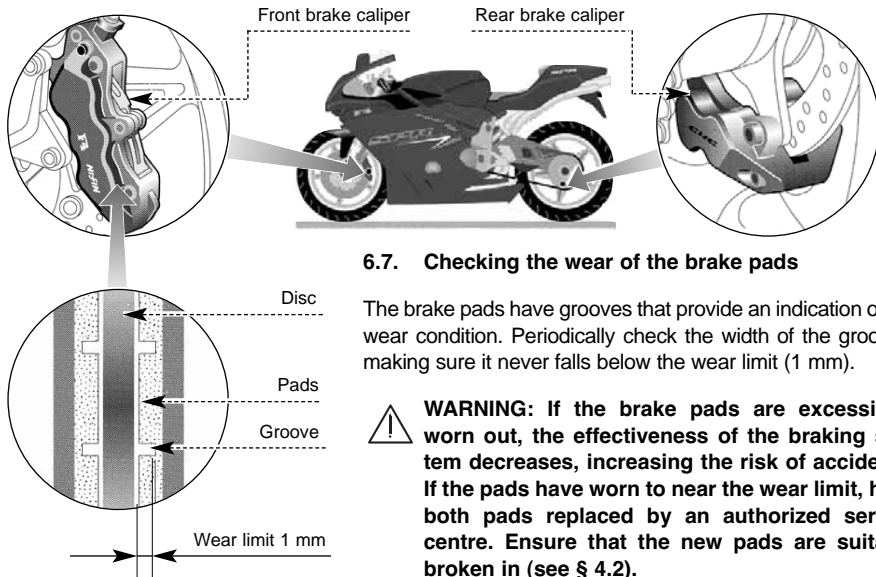

6.7. Checking the wear of the brake pads

The brake pads have grooves that provide an indication of the wear condition. Periodically check the width of the grooves, making sure it never falls below the wear limit (1 mm).



WARNING: If the brake pads are excessively worn out, the effectiveness of the braking system decreases, increasing the risk of accidents. If the pads have worn to near the wear limit, have both pads replaced by an authorized service centre. Ensure that the new pads are suitably broken in (see § 4.2).

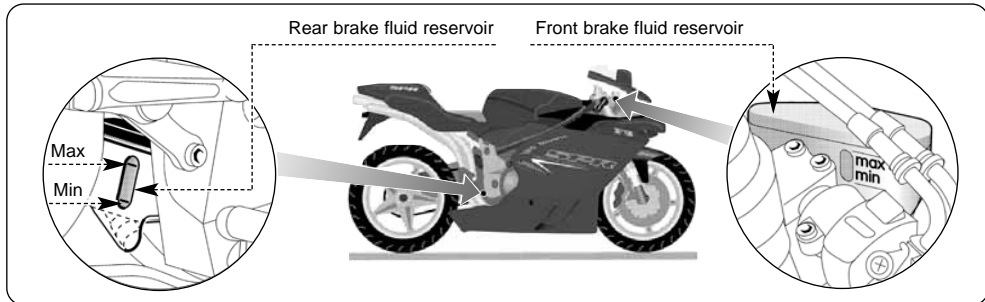

6.8. Checking the brake fluid level



WARNING

Lack of maintenance of the braking system can increase the risk of accidents. Before riding, always check the braking system according to the instructions provided at § 4.8. of this manual.

The level of the brake fluid decreases as the brake pads wear down. Ensure that the fluid level is always between the MAX and MIN marks. If the level falls below the MIN mark, contact an authorized service centre and have the brake system overhauled.

**WARNING**

Never use your motorcycle if the fluid level is below the MIN mark. The brakes may fail to properly operate, which could lead to an accident. If the brake fluid level is below the MIN mark, you must have it topped up by an authorized MV Agusta dealer.

**WARNING**

Have the topping up of the brake fluid performed only by skilled personnel. Brake fluid is highly toxic. Avoid contact and ingestion. Keep brake fluid out of reach of children and domestic animals. In the event of a brake fluid ingestion, immediately call a doctor and do not cause vomiting, in order to avoid inhalation of brake fluid in lungs. If the brake fluid comes in touch with your skin or eyes, immediately wash with water.

**WARNING**

Use only the brake fluid specified at paragraph 6.3. of this manual. Mixing different brake fluids can cause a dangerous chemical reaction, as well as the decrease of the braking efficiency, with subsequent increase of the risk of accidents.

**WARNING**

An insufficient amount of brake fluid may allow the introduction of air in the braking system. This could compromise the effectiveness of the braking system, with subsequent increase of the risk of accidents. Presence of air in the braking system can be identified in the moment you feel a characteristic “spongy effect” while pushing the brake pedal. In this case, have a braking system bleeding performed by an authorized MV Agusta dealer before riding your motorcycle again.



6.9. Checking the clutch fluid level

The fluid level must be between the MAX and MIN marks.

If the level falls below the MIN mark, contact an authorized service centre and have the clutch control system repaired.



WARNING

Never use your motorcycle if the fluid level is below the MIN mark. The clutch may fail to properly operate, which could lead to an accident. If the clutch fluid level is below the MIN mark, have it topped up by an authorized MV Agusta dealer.



WARNING

Use only the clutch fluid specified in the paragraph 6.3. of this manual.

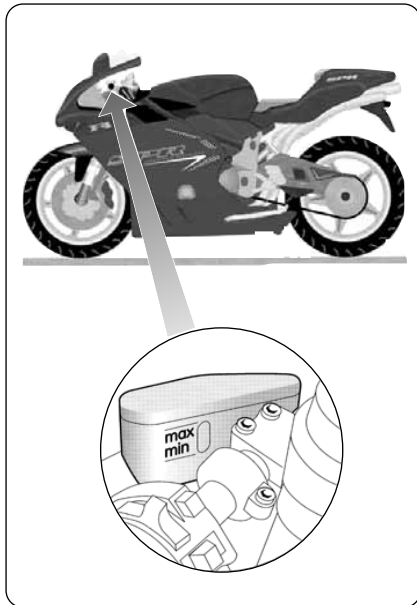



6.10. Checking and replacing the tyres



WARNING

Before using the motorcycle, always check the pressure and wear of the tyres.

Checking the inflating pressure of the tyres is an essential requirement to ensure driving safety. Insufficiently inflated tyres can reduce the handling of the motorcycle and wear themselves out very quickly. On the other hand, an excessively high inflating pressure reduces the wideness of the surface in contact with the ground, and it can compromise the grip of the vehicle.

Before riding your motorcycle, it is therefore necessary to measure the tyre pressure at room temperature. The vehicle must be parked since three hours at least.

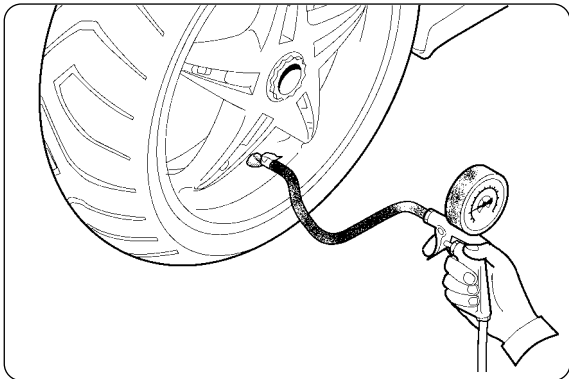

WARNING

An incorrect inflating pressure can lead to dangerous situations during riding. An insufficiently inflated tyre can cause the sliding of the tyre on the wheel rim or its detachment; this may lead to the deflation of the tyre with subsequent loss of control of the vehicle.



In fact, by checking the pressure soon afterwards using the motorcycle, you would obtain a higher value than the actual one. This could cause an incorrect adjustment of the tyre pressure.

Refer to the pressures given in § 8.2. and/or on the label applied on the front fairing. In the event of long travels, you can increase the face value of the tyre pressure of 0.2 bar.

Moreover, it is extremely important to check the wear of the tyres before riding. In fact, a worn out tyre can be punctured more easily than a new one, and it can adversely affect handling and stability of the motorcycle.

Check that the depth of the tyre tread is not below the values prescribed by the Highway Code.

Verify the absence of crevices at the bottom of the tread design and fissures on the tyre sidewall. Moreover, verify the absence of nails and glass splinters in the tyre. If these conditions are not verified, have the tyre replaced by an authorized MV Agusta dealer.

**WARNING**

The limits of the tyre tread depth may vary from country to country. Always refer to the values prescribed by the law provisions of the nation in which you use your motorcycle.

**WARNING**

• If the tyres of your motorcycle are excessively worn out, have it replaced by your MV Agusta dealer. Besides being illegal, riding a motorcycle with excessively worn out tyres can reduce its stability and lead to the loss of control of the vehicle.

• If a tyre is punctured it must be replaced, not repaired. A repaired tyre provides a restricted performance and lower safety levels than a new one. If you make a provisional or emergency repair to a tyre, you must ride at very low speed until you reach the nearest



MV Agusta dealer and have the tyre replaced. With a provisionally repaired tyre, never exceed 60 km/h. Tyre repairing must never be performed if the tyre is punctured on its sidewall, or if the diameter of the puncture on the tread is greater than 6 mm.

- MV Agusta recommends not to use sealing fluids to repair a punctured tyre. These products can adversely affect the material of the tyre layers, as well as hide the minor damages caused by objects penetrated in the tyre.
- When it is necessary to replace the tyres, use only the type specified in paragraph 8.2. Moreover, avoid using tyres of a different brand or type on the front and on the rear wheel at the same time. Using tyres different from those specified can adversely affect the handling and stability of the motorcycle, increasing the risk of accidents.
- Have the tyres replaced according to

their direction of spin, which is highlighted by a small arrow on the tyre sidewall.

- The wheel rims of your motorcycle have been designed for use with tubeless tyres only. Do not assemble an air tube tyre on rims designed for tubeless tyres. Otherwise, the tyre bead could not properly settle down on the wheel rim, leading to the deflation of the tyre and the loss of control of the vehicle.
- Do not assemble an air tube on a tubeless tyre. The overheating of the tyre could cause the explosion of the air tube, leading to the deflation of the tyre and the loss of control of the vehicle.
- New tyres should be run in for a short period before demanding their full performance. In fact, during this period the tyres could have a reduced grip on some kind of roads. We suggest to ride at reduced speed and exercise extreme caution during the first 100 km after the replacement of a tyre.



❑ Rear wheel disassembling



CAUTION

If you have the rear wheel tyre replaced by a tyre-dealer, make sure that the following tools are used in the rear wheel disassembling and reassembling:

- 55 mm polygonal socket wrench
- Torque wrench

If the above mentioned operations are performed with tools other than those indicated, the rear wheel parts can be seriously damaged. Therefore, we strongly recommend not to have the tyres replaced by an improperly equipped workshop. Always have the tyres replaced by an authorized MV Agusta dealer.

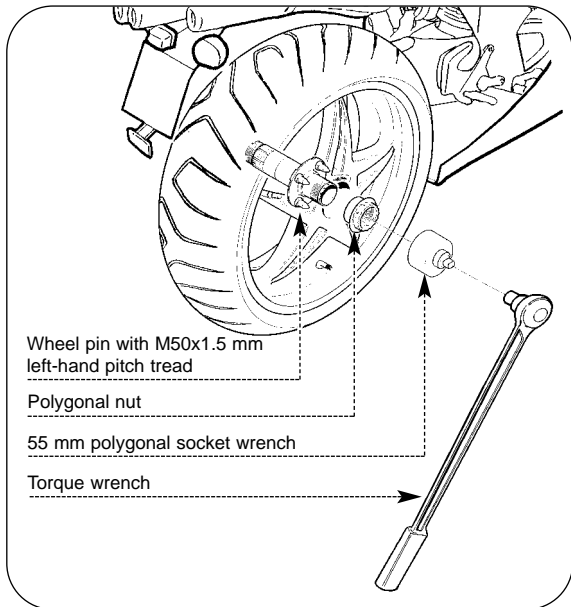



□ Checking the wheel rims

Before riding, always verify the absence of cracks, bending or buckling on the wheel rims.



WARNING

If you find that the wheel rim is damaged, have it replaced by an authorized MV Agusta dealer. Never attempt to repair the wheel rim, even in case of slight damage.

Every time you replace a tyre or a rim, you must have a wheel balancing performed by an authorized MV Agusta dealer. Wheel unbalance can adversely affect performance and handling of the motorcycle, as well as shorten the life of the tyres.



WARNING

When you have a wheel balancing performed, make sure to assemble only approved counterweights on the wheel rim. MV Agusta recommends not to use balancing or balancing/sealing fluids.



WARNING

Do not attempt to have a tubeless tyre removed without using the proper tools and protections for the wheel rim. Otherwise, you could damage the sealing surface of the rim, leading to the deflation of the tyre and the loss of control of the vehicle.



6.11. Checking and lubricating the drive chain

To perform this operation, you must put the motorcycle on the rear stand, upright on a horizontal surface and with the gear in neutral.

□ Checking the chain adjustment

The **h** distance between the axis of the chain and the lower chain guard changes according to the number of teeth of the rear sprocket (see table). Manually turn the rear wheel and carry out the check at several points along the chain. The distance between the chain and the lower chain guard must remain constant as the wheel turns. If the chain is only partially loosened, it means that some chain links are flattened or seized. If the distance is greater than the indicated value, have the chain adjusted by your local MV Agusta dealer.

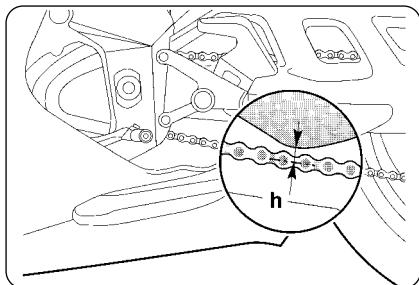

Number of teeth of the rear sprocket	Z = 37	Z = 38	Z = 39
h	2 mm	4 mm	6 mm

**WARNING**

Riding your motorcycle when the drive chain is in poor condition or improperly adjusted can lead to accidents. Before riding, always check the chain adjustment according to the procedures shown in this paragraph. If necessary, have the chain adjusted by your MV Agusta dealer.

**WARNING**

If any chain link is flattened or seized, you must correctly lubricate the chain according to the procedures shown in the following paragraph.

**WARNING**

If you notice damage or excessive wear of the chain and the correspondent sprockets, have them replaced by an authorized MV Agusta dealer. Every time the chain is replaced, you must always replace the front and rear sprockets too.

**WARNING**

Using a chain with a fake link can be dangerous. An uncompletely riveted or fake link can accidentally split open and cause accidents, as well as damage to the engine. Never use a chain with a fake link.

**WARNING**

Every time it is requested to operate the rear wheel hub screws, contact an authorized MV Agusta dealer. In order to tighten the screws, apply a tightening torque equal to the value shown in the label placed on the swingarm (see paragraph §2.2.). Applying a torque higher than the indicated value can cause the fast decay of the rear wheel hub, compromising the reliability of the vehicle and the safety of the pilot.



□ Lubrication

To ensure proper operation, the drive chain needs to be properly lubricated.

▶ Preliminary cleaning - Before lubrication, the dirt accumulated on the chain must be dissolved using kerosene. The dirt must then be removed with a clean rag and/or an air jet.



CAUTION

The chain is of the O-ring type. To prevent it from damaging, never clean the chain with a steam or high pressure water jet, nor using gasoline or other solvents. The chain must be cleaned using kerosene only.



WARNING

Kerosene is highly toxic and flammable. Avoid contact and inhalation. Keep kerosene away from sparks and flames. Keep kerosene out of reach of children and domestic animals. Correctly dispose of exhaust kerosene, in order to avoid environmental pollution.

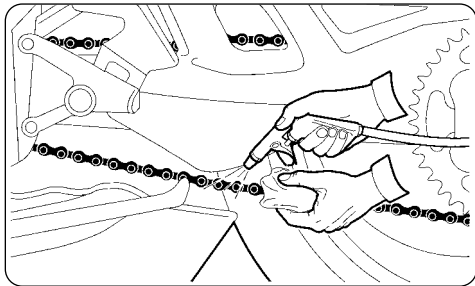



► **Lubrication** - Apply a slight and uniform film of lubricant over the whole of the drive chain, taking care not to smear the surrounding parts, and in particular the tyres.

**CAUTION**

Only use the recommended lubricant or an equivalent product (see § 6.3.).

**WARNING**

Chain lubrication must be performed according to the intervals specified in the tables of scheduled maintenance (see § 6.1.). It is also necessary to perform this operation after riding under the rain and after cleaning the motorcycle. Riding your motorcycle when the drive chain is in poor condition or improperly adjusted can lead to accidents.

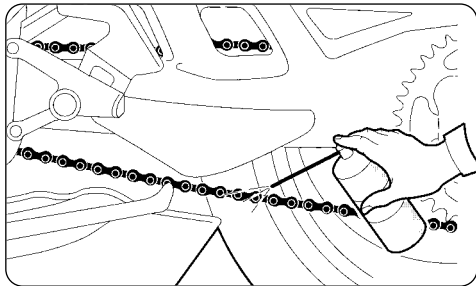



6.12. Checking the idle speed

Check the idle speed when the engine has reached the operating temperature. Ensure that the choke control has not been activated.

The idle speed should range from 1,050 to 1,250 rpm.

If a tune-up is necessary, contact an authorized service centre.

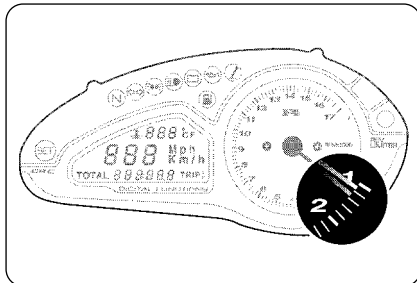



6.13. Replacing parts - General information

The replacement of the fuses (except for the battery recharge fuse) and the light bulbs (excepting the front parking light bulbs) can be carried out by the owner according to the indications provided below.

	Battery recharge fuse - Replacement (§6.13.1)
	Service fuses - Replacement (§ 6.13.1)
	Low beam bulb - Replacement (§6.13.2.)
	High beam bulb - Replacement (§6.13.3.)
	Front parking light bulbs - Replacement
	Front turn indicator bulbs - Replacement (§6.13.4)
	Rear turn indicator bulbs - Replacement (§6.13.5)
	Rear light and brake light bulb - Replacement (§ 6.13.6)
	License plate light bulb - Replacement (§ 6.13.7)

6.13.1. Replacing the fuses

► The recharge fuse is located on the left side of the motorcycle, in the position shown in the figure.

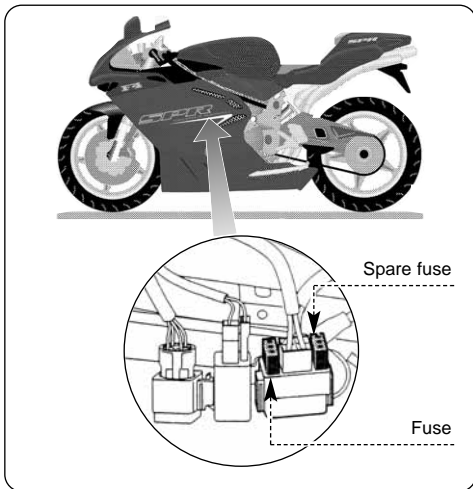



- ▶ The service fuses are located on the right side. To expose them, remove the side fairing (see § 6.4).
- ▶ Remove the fuse box cover.

**CAUTION**

Turn the ignition key on the “OFF” position before checking or replacing the fuses, in order to avoid a short circuit with subsequent damage to other electric parts of the motorcycle.

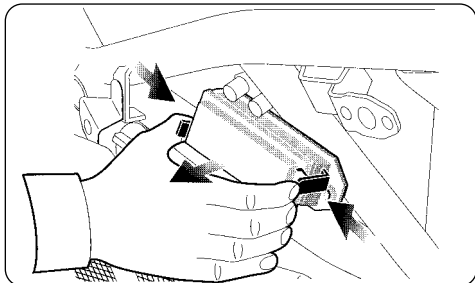



► Replace the blown fuse and refit the cover. To identify the position and function of the fuses, refer to the information shown on the adhesive label and in the enclosed electrical diagram. The reference letters in the figure correspond to those shown in the diagram.

Remember that the tool bag contains two spare fuses.

**WARNING**

Never replace a fuse with a rating other than that prescribed, in order to avoid damage to the electrical equipment of the motorcycle which could lead to a fire.

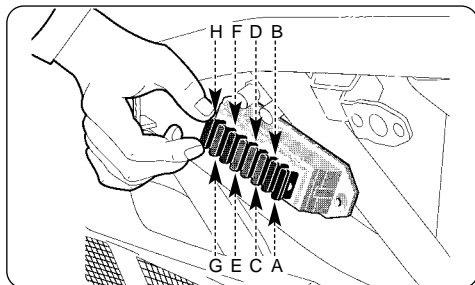



6.13.2. Replacing the low beam bulb

- ▶ Remove the cover.

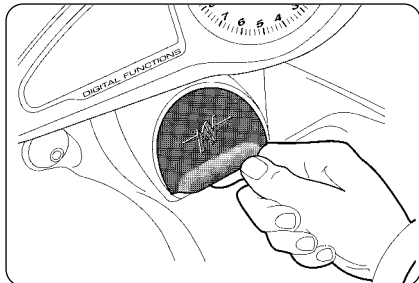

- ▶ Release the retaining spring.
- ▶ Extract the bulb.
- ▶ Detach the connector.



Caution: Do not touch the bulb glass with bare hands. If you do, clean the bulb with an oil-free solvent.

- ▶ Attach the connector.
- ▶ Fit the new bulb.
- ▶ Reattach the spring.
- ▶ Replace the cover.

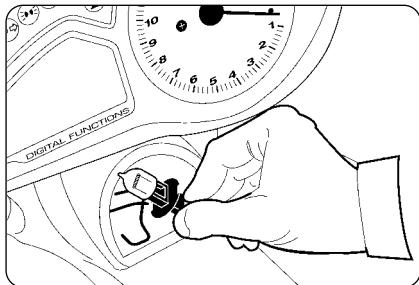



6.13.3. Replacing the high beam bulb

- ▶ Remove the cover.

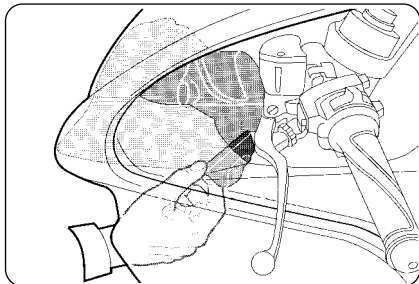

- ▶ Detach the connector.
- ▶ To remove the bulb, rotate it counterclockwise.
- ▶ Insert and lock the new bulb in place by rotating it clockwise.



Caution: Do not touch the bulb glass with bare hands. If you do, clean the bulb with an oil-free solvent.

- ▶ Reattach the connector.
- ▶ Replace the cover.

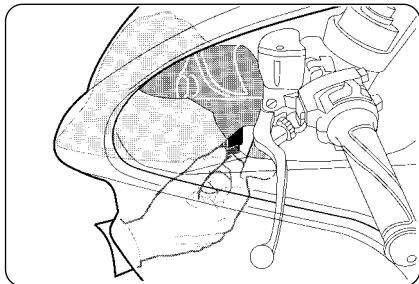



6.13.4. Replacing the front turn indicator bulbs

- ▶ Remove the lens.

- ▶ Pull out the burnt-out bulb.
- ▶ Insert the new bulb.
- ▶ Replace the lens.

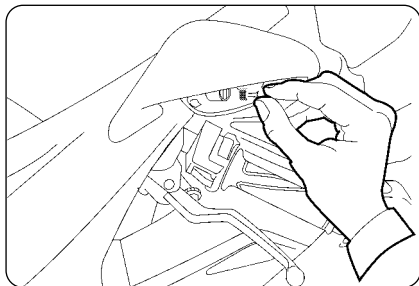
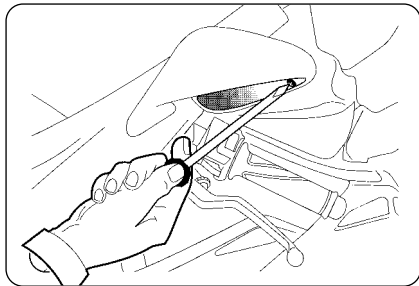



6.13.5. Replacing the rear turn indicator bulbs

- ▶ Remove the lens.
- ▶ To remove the burnt-out bulb, press it and rotate it counterclockwise.
- ▶ To fit the new bulb, press it and rotate it clockwise.
- ▶ Replace the lens.

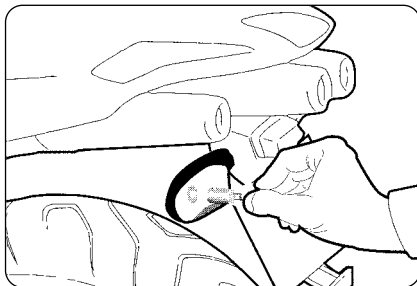
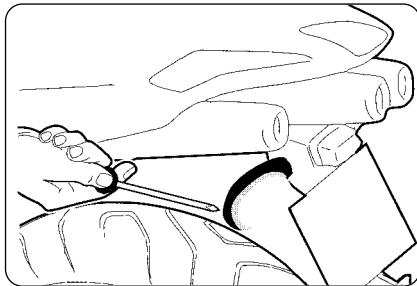



6.13.6. Replacing the rear light and brake light bulb

- ▶ Lift the seat (§ 4.6.).
- ▶ Remove the bulb holder by turning it counterclockwise.

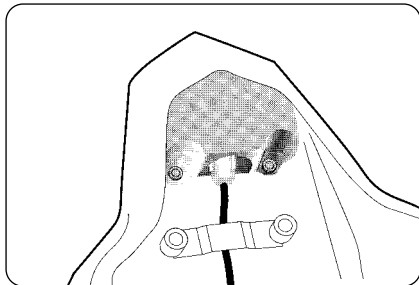

- ▶ To remove the bulb, press it and rotate it counterclockwise.
- ▶ To fit the new bulb, press it and rotate it clockwise.
- ▶ Replace the bulb holder and lock it in place by rotating it clockwise.

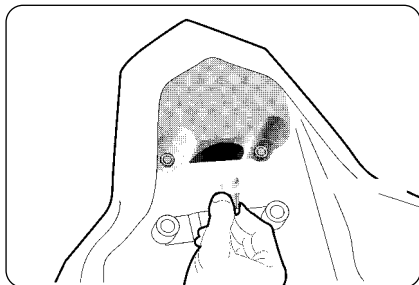



6.13.7. Replacing the license plate light bulb

- ▶ Pull out the bulb holder.
- ▶ Extract the burnt-out bulb.
- ▶ Fit the new bulb.
- ▶ Replace the bulb holder.

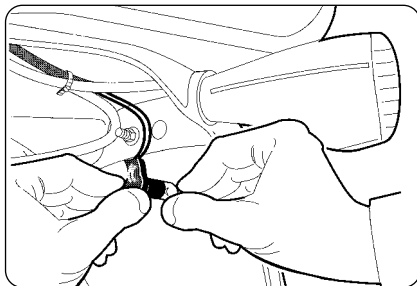
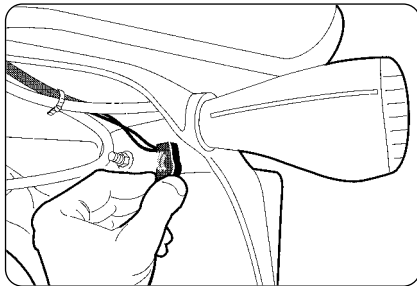



6.14. Battery

The battery is of the maintenance-free type and is installed under the tail section. This battery does not require checking of the fluid level or adding of distilled water.

If the battery seems to be run-down (causing electrical problems or a difficult starting), have it recharged by an authorized MV Agusta dealer as soon as possible. Remember that the battery runs down more quickly if your motorcycle is equipped with additive electrical accessories.



WARNING

If the battery casing is damaged, there may be a leakage of sulphuric acid, a HIGHLY TOXIC AND CORROSIVE substance. Avoid any contact with your eyes, skin and clothes. Always wear protective glasses when you have to work near the battery.

In the event of a contact with sulphuric acid, give the FIRST AID as described below:

- **CONTACT WITH EYES:** Wash away with water for about 15 minutes, and immediately call a doctor.
- **CONTACT WITH SKIN:** Wash away with a great amount of water.
- **INGESTION:** Drink great amounts of water or milk, and immediately call a doctor.

Furthermore, leakage of sulphuric acid can result in the formation of hydrogen gas which, if ignited by a spark or a flame, would cause an explosion.

Always have the battery replaced by your local MV Agusta dealer.



Prolonged inactivity

If the motorcycle is to remain unused for a long time (a month or longer), it is advisable to disconnect the battery cables or have the battery removed by skilled personnel. In case of prolonged inactivity, to avoid shortening the life of the battery, it is essential to have it recharged by your MV Agusta dealer every 4-5 months.



WARNING: The inversion of the battery wires can damage the battery and the recharging system. The red wires must be connected to the positive terminal (+), while the black wires must be connected to the negative terminal (-).
When removing the battery, disconnect the negative terminal FIRST and then the positive terminal. When reinstalling the battery, use the reverse procedure.

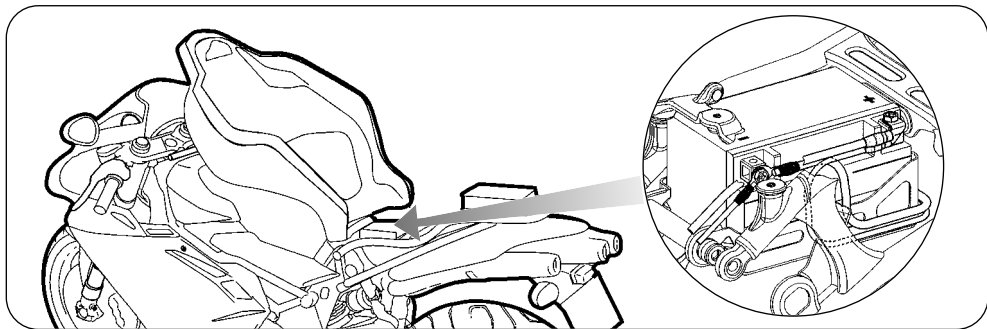



6.15. Cleaning the motorcycle

Periodic careful cleaning is a key factor in preserving the value of the motorcycle, protecting its surface finish and checking for damages, wear and leakage of corrosive fluids.



CAUTION

Before washing the vehicle, stop up the exhaust pipes and protect the electrical parts.



WARNING

Do not wash your motorcycle soon afterwards riding. Attend a few minutes to allow the engine and the exhaust pipes to thoroughly cool.

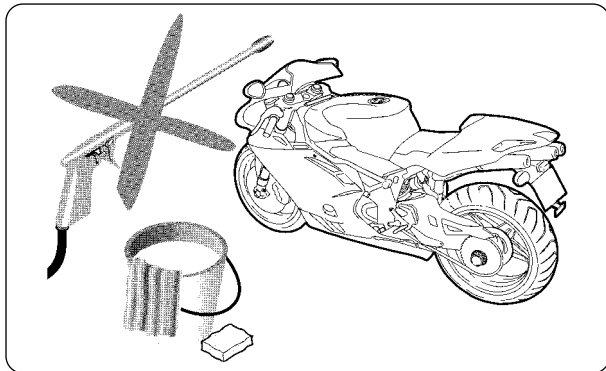

CAUTION: Never use washing systems involving steam or high pressure water jets. These systems could cause water infiltration and damage the internal parts of your motorcycle.



INFORMATION: Spilling detergent can cause environmental pollution. Therefore, you should clean your motorcycle in an area equipped for collection and disposal of washing fluids.



Wash the motorcycle with water, a mild detergent and a sponge. Wipe the vehicle with a soft cloth. Use an air jet to dry difficult-to-reach areas.

**CAUTION**

- Avoid using clothes or sponges that have been in contact with strong or abrasive detergents, solvents or gasoline.
- To avoid irreparable damage to the front fairing, never use alkaline or strongly acid detergents, petrol, brake fluid or other solvents. Clean the front fairing only with a soft cloth, warm water and a neutral detergent.

Periodically treat the paintwork with high quality wax. After riding on roads treated with corrosive substances (salt), wash the vehicle as soon as possible with cold water. Do not use hot water as it enhances the corrosive action.

**WARNING**

Avoid smearing brakes or tyres with oil or wax. If necessary, clean the brake discs with a brake disc detergent, and wash the tyres with warm water and a neutral detergent.

**WARNING**

The presence of water on the brakes can lead to a decrease of the braking effectiveness with subsequent risk of accidents. After completing the washing, run the engine for a few minutes and start off at reduced speed. Carefully apply the brakes a few times so as to dry the brake pads and discs.







**WARNING**

The drive chain must be correctly lubricated after washing the motorcycle, following the instructions provided at § 6.11. of this manual.



6.16. Prolonged inactivity

If the motorcycle is to remain unused for a long time, it is advisable to carry out the following operations:

	Empty the fuel tank.
	Remove the battery and store it in a suitable place.
	Remove the spark plug caps and the spark plugs. Pour a teaspoonful of engine oil in every spark plug hole, then place back the spark plugs and the corresponding caps. Make the engine run idle for a few times.
	Lubricate all control cables and the joints of all pedals and levers.
	Clean the motorcycle and treat the paintwork with high quality wax (§ 6.15.).
	In order to ensure integrity and performance of the tyres, park your motorcycle in a fresh, dry and dark place, with a temperature relatively constant and lower than 25° C. Avoid direct contact of the tyres with heating pipes or radiators, and prolonged contact with oil or gasoline. Avoid parking with the tyres near to electrical motors or devices capable to produce sparks or electric discharge. During the period of inactivity, place your motorcycle on the rear stand (§4.7.).
	Cover the vehicle with the canvas cover supplied.

When the motorcycle is first put back into service, remember to carry out a comprehensive check (§ 4.8.) and, if necessary, to have the vehicle serviced (§ 6.1.).

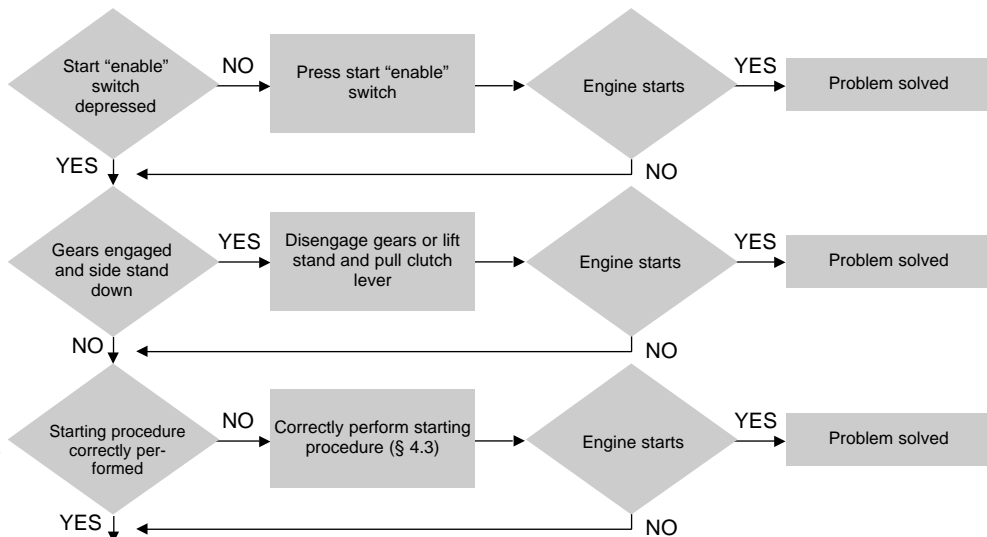
**7.1. Engine problems: ENGINE DOES NOT START**

continued on next page



continued from previous page

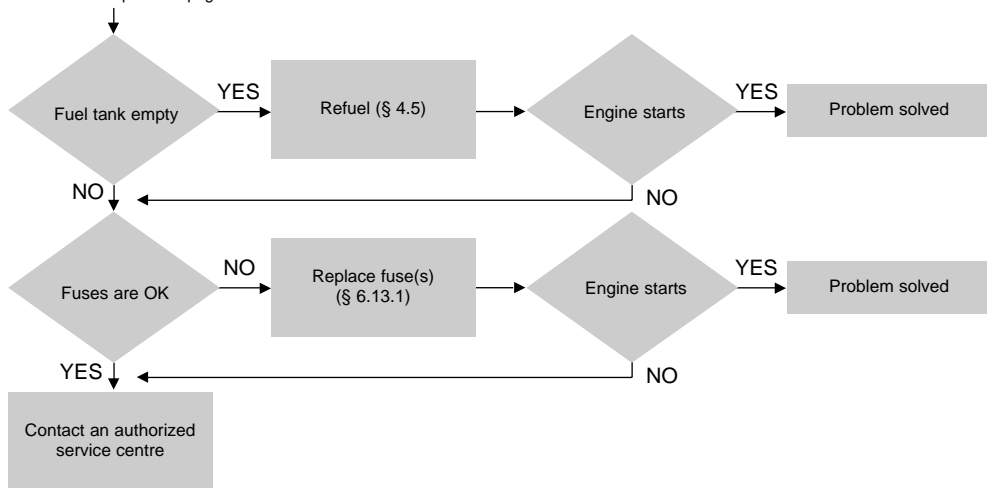

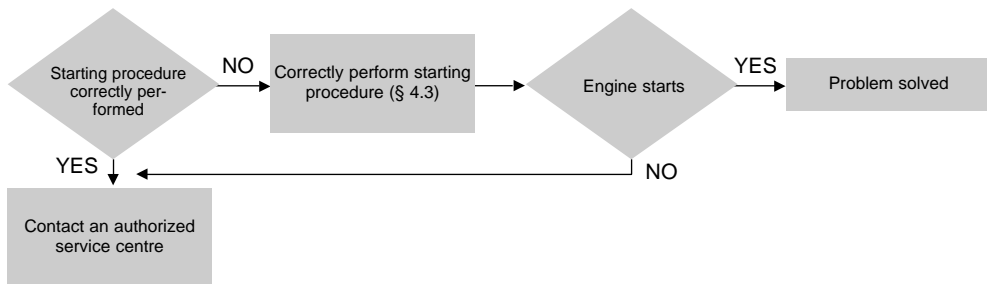
**ENGINE IS DIFFICULT TO START**



ENGINE OVERHEATS

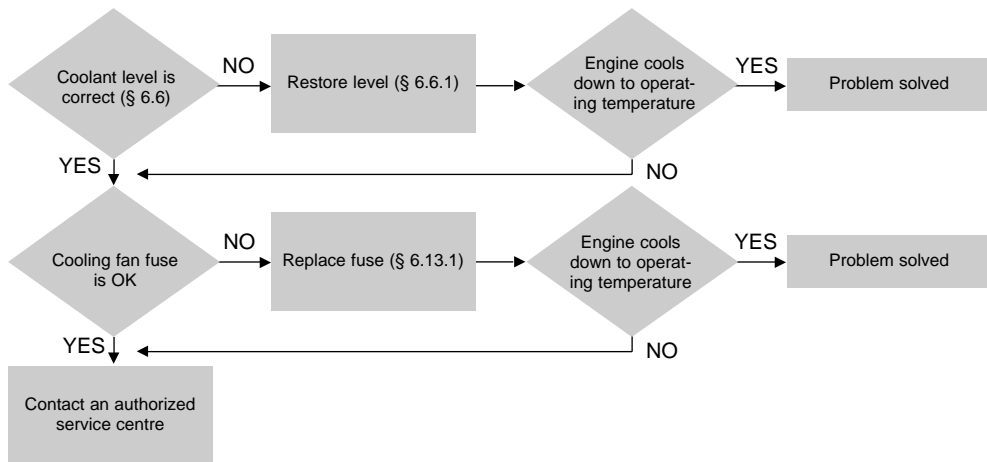

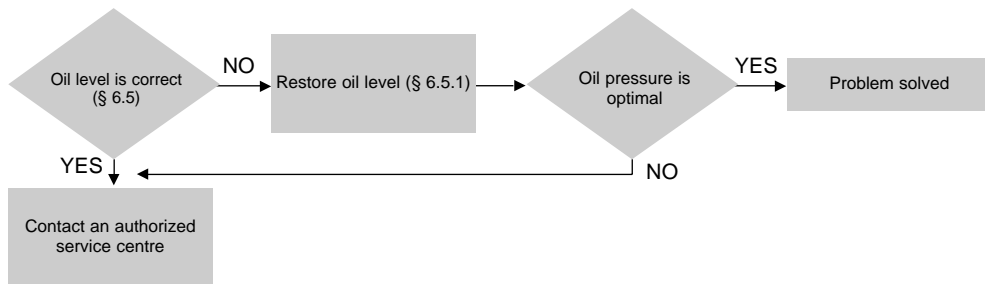
**OIL PRESSURE IS TOO LOW**



7.2. Electrical equipment problems: **LIGHTS DO NOT WORK**

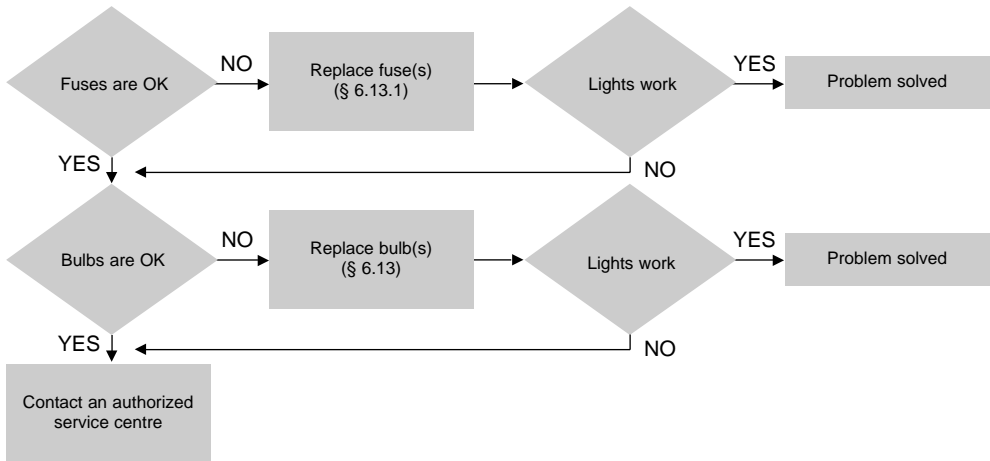



HORN DOES NOT WORK

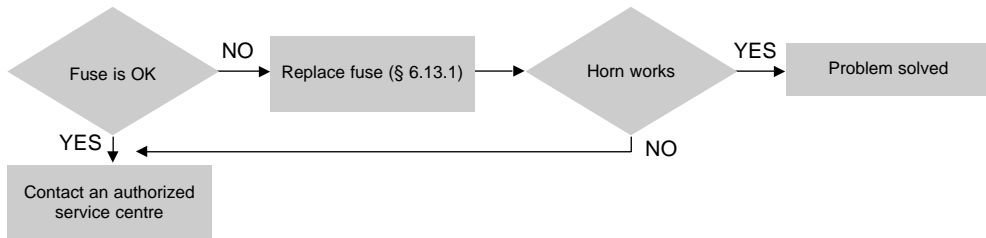

SPEEDOMETER DOES NOT WORK

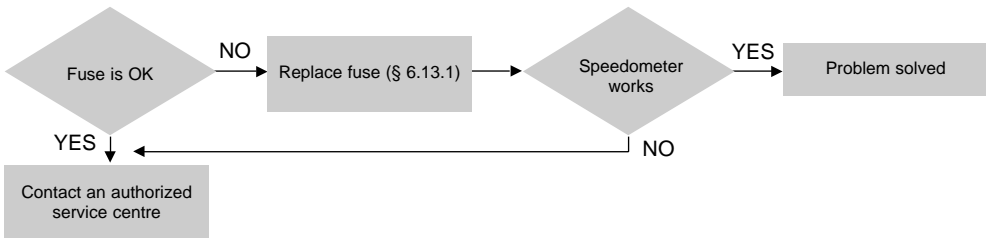

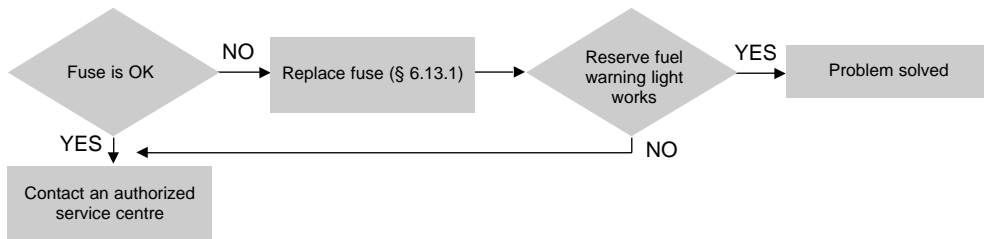
**RESERVE FUEL WARNING LIGHT DOES NOT WORK****ALTERNATOR DOES NOT CHARGE BATTERY**

Contact an authorized
service centre



8.1. Motorcycle overview

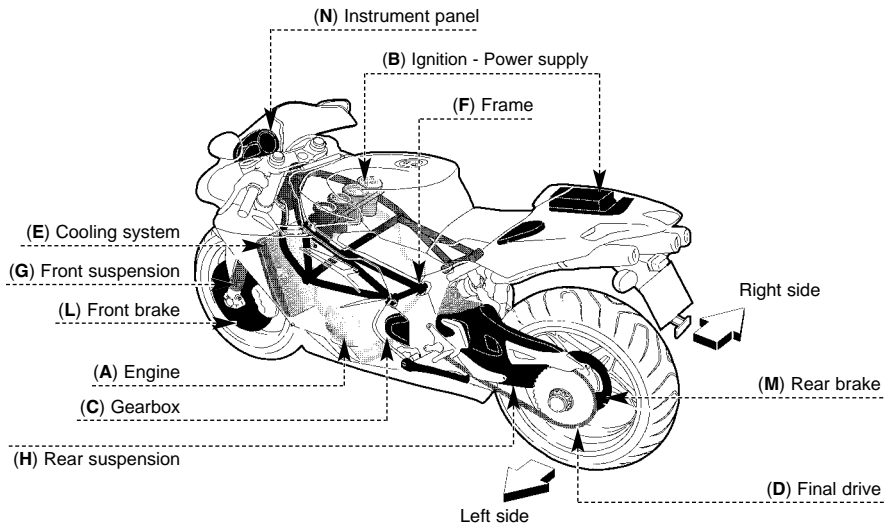



- A - Engine:** four-stroke, inline four-cylinder. Double-overhead camshaft valve train with radial valves. Wet sump lubrication.
- B - Ignition - Power supply:** integrated ignition-injection system. Inductive-discharge electronic ignition. "Multipoint" electronic injection.
- C - Gearbox:** removable, six-speed, with constant-mesh gears.
- D - Final drive:** consisting of drive sprocket, rear sprocket and chain.
- E - Cooling system:** liquid cooling with water-oil heat exchanger.
- F - Frame:** tubular steel trellis with aluminum side plates.
- G - Front suspension:** upside-down hydraulic fork with external adjusting system.
- H - Rear suspension:** progressive, with single-sided swingarm and single shock absorber with external adjusting system.
- L - Front brake:** dual semi-floating disc with six-piston calipers.
- M - Rear brake:** single disc with four-piston caliper.
- N - Instrument panel:** with warning lights and analogue and digital instruments.



8.1.1 Front brake circuit

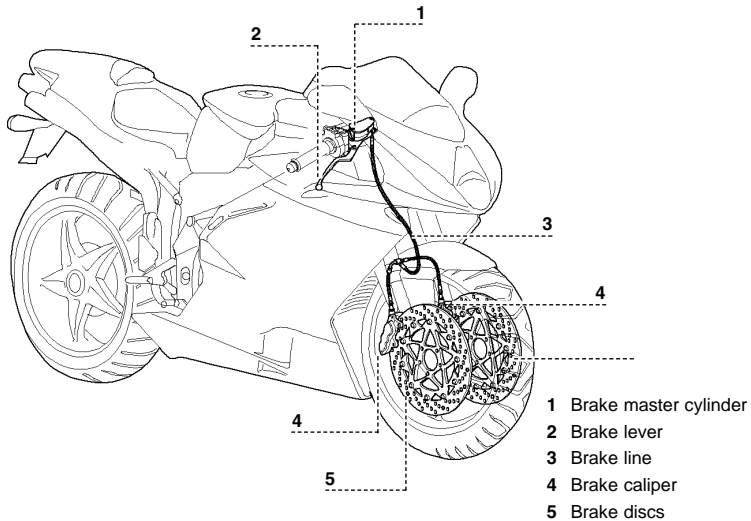



8.1.2. Rear brake circuit

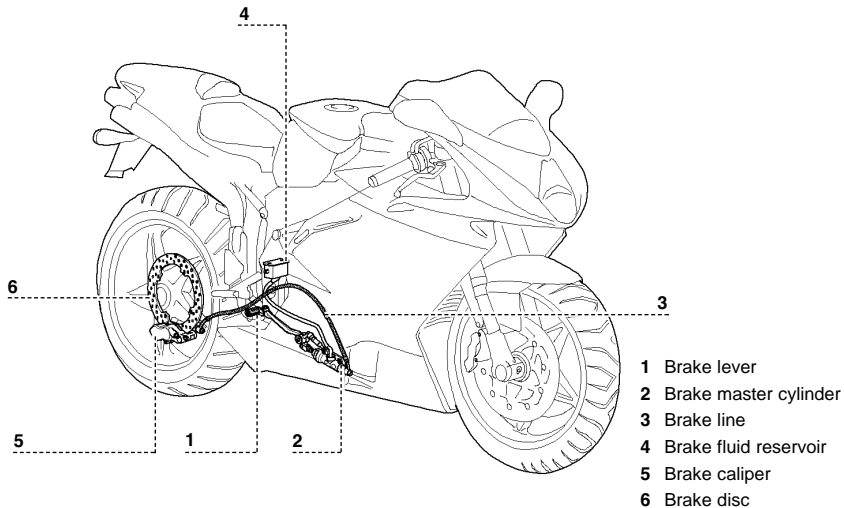



8.1.3. Clutch circuit

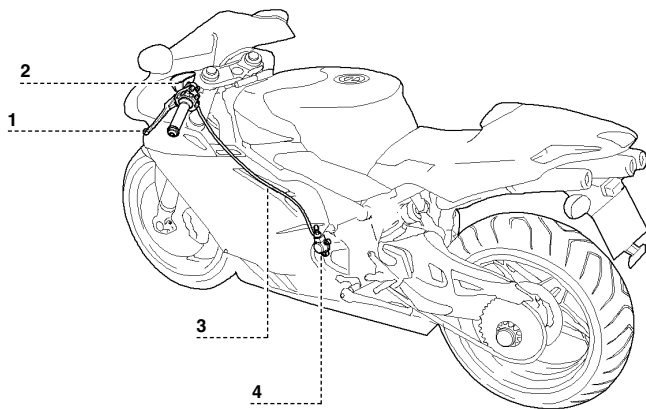

- 1 Clutch lever
- 2 Clutch master cylinder
- 3 Clutch line
- 4 Clutch cylinder assembly



8.1.4. Engine lubrication

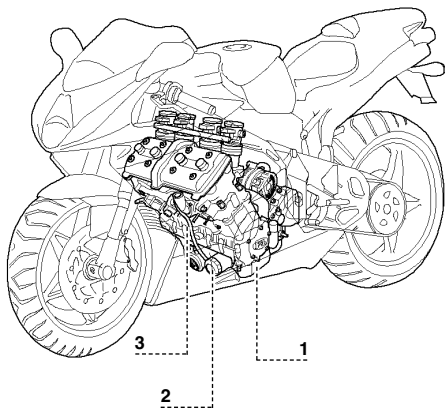

- 1 Oil sump
- 2 Oil filter
- 3 Cylinder head oil feed pipe



8.1.5. Coolant circuit

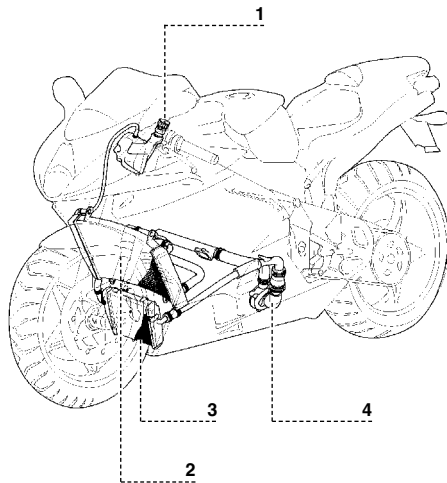

- 1 Expansion tank
- 2 Upper radiator
- 3 Lower radiator
- 4 Coolant pump



8.1.6. Fuel system

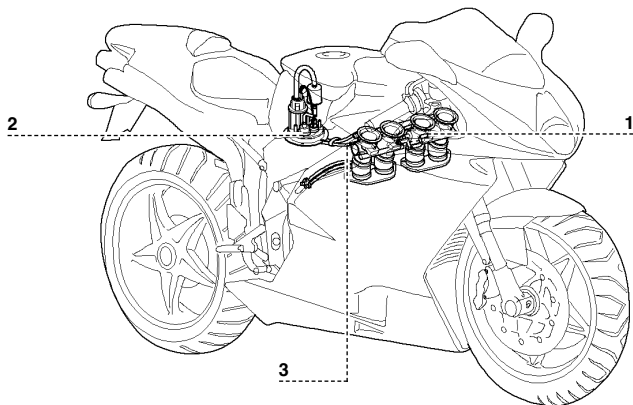

- 1 Throttle bodies
- 2 Fuel pump
- 3 Fuel line

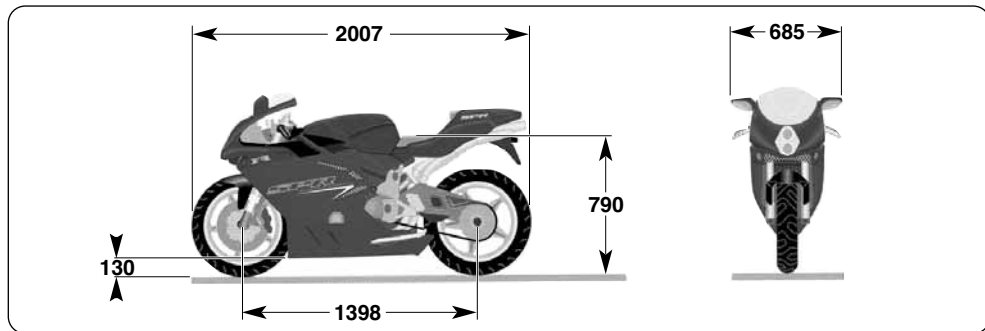

8.2. Specifications

SPECIFICATIONS

Wheelbase (mm) (*)	1398
Overall length (mm) (*)	2007
Max. width (mm)	685
Seat height (mm) (*)	790
Min. ground clearance (mm) (*)	130
Trail (mm) (*)	98.5

* : The indicated values must not be intended as binding informations. They can change according to the vehicle setup.



Specifications

Dry weight (kg)	188
Fuel tank capacity (lt) (*)	21
Reserve fuel (lt) (*)	4
Oil in crankcase (kg)	3.5
ENGINE	
Type	Four-cylinder, four-stroke, 16 valves
Bore (mm)	73.8
Stroke (mm)	43.8
Total displacement (cm ³)	749.4
Compression ratio	13 : 1
Starting	Electric starter
Cooling system	Liquid cooling with water-oil heat exchanger
Crankcase and covers	die-cast
Head and cylinders	chill-cast
Valves	bimetal / single-metal
VALVE TRAIN	
Type	Double-overhead camshaft, radial valves
LUBRICATION	
Type	Wet sump

* : The indicated data must not be intended as binding informations. They can change according to the environmental temperature, the engine temperature and the evaporation point of the gasoline.



Specifications

IGNITION - POWER SUPPLY			
Type	"Weber-Marelli" 1.6 M integrated ignition-injection system Inductive discharge electronic ignition, "Multipoint" electronic injection		
Spark plugs	Champion G 54 V		
Spark gap (mm)	No gap		
CLUTCH			
Type	Multiple-disc in oil bath		
PRIMARY DRIVE			
Number of teeth on crankshaft gear	Z = 47		
Number of teeth on clutch gear	Z = 81		
Transmission ratio	1.72		
SECONDARY DRIVE			
Number of teeth on front sprocket	Z = 15		
Number of teeth on rear sprocket	Z = 37	Z = 38	Z=39
Transmission ratio	2.47	2.53	2.60
TRANSMISSION			
Type	Removable, six-speed gearbox with constant-mesh gears		
Gear ratio (overall ratios)			
First gear	2.47 (10.49)	2.47 (10.75)	2.47 (11.04)
Second gear	2.06 (8.75)	2.06 (8.96)	2.06 (9.21)
Third gear	1.80 (7.65)	1.80 (7.83)	1.80 (8.05)



Specifications

Fourth gear	1.58 (6.71)	1.58 (6.87)	1.58 (7.06)
Fifth gear	1.43 (6.07)	1.43 (6.22)	1.43 (6.39)
Sixth gear	1.33 (5.65)	1.33 (5.79)	1.33 (5.95)
FRAME			
Type	CrMo steel tubular trellis (TIG welded)		
Swingarm pivot plates	Aluminium alloy		
FRONT SUSPENSION			
Type	"Upside down" telescopic hydraulic fork with rebound-compression damping and spring preload adjustment		
Rod diameter (mm)	50 with Titanium Nitride treatment		
Travel on leg axis (mm)	118		
REAR SUSPENSION			
Type	Progressive, single shock absorber with rebound-compression (high speed/low speed) damping and spring preload adjustment		
Swingarm	Aluminium alloy		
Wheel travel (mm)	120		
FRONT BRAKE			
Type	Double steel floating disc		
Disc diameter (mm)	310		
Disc flange	Aluminium		
Calipers, piston diameters (mm)	6-piston Ø 22.65; Ø 25.4; Ø 30.23		



Specifications

REAR BRAKE	
Type	Single steel disc
Disc diameter (mm)	210
Caliper, piston diameter (mm)	4-piston, Ø 25.4
FRONT RIM	
Material	Aluminium alloy
Dimensions	3.50" x 17"
REAR RIM	
Material	Aluminium alloy
Dimensions	6.00" x 17"
TYRES	
Front	120/65-ZR 17 (56 W)
Rear	190/50-ZR 17 (73 W) or 180/55-ZR 17 (73 W)
Brand and type	PIRELLI - Dragon Evo MTR 21 Corsa (Front) PIRELLI - Dragon Evo MTR 22 Corsa (Rear)
Inflating pressure (*)	
Front	2.5 bar (35.6 psi)
Rear	2.5 bar (35.6 psi)

* : If you use tyres of a brand different from the ones recommended, refer to the inflating pressure values marked by the manufacturer on the tyre sidewall.



Specifications

ELECTRICAL EQUIPMENT	
Equipment voltage	12V
Low beam	12V 55W
High beam	12V 60W
Dual-bulb front parking light	12V 5W
Rear light	12V 5W
Brake light	12V 21W
Turn indicators	12V 10W
Battery	12V - 9Ah
Alternator	650W at 5000 rpm
BODYWORK	
Fairing	Thermoplastic material
Front fairing	Thermoplastic material
Tail section	Thermoplastic material
Fuel tank	Steel
Air box	Thermoplastic material
Air scoops	Thermoplastic material
Air scoop covers	Carbon fibre
Air box side panels	Carbon fibre
Front mudguard	Carbon fibre



Specifications

Electrical equipment covers	Aluminium
Chain guards	Carbon fibre
Battery support	Steel
Exhaust pipe guard	Aluminium
Heat shield	Thermoplastic material
License-plate holder	Thermoplastic material



8.3. Carbon components

- 1 - Right-hand side panel.
- 2 - Left-hand side panel.
- 3 - Ignition switch and steering lock cover.
- 4 - Front mudguard.
- 5 - Lower chain guard.
- 6 - Upper chain guard.
- 7 - Right-hand air scoop cover.
- 8 - Left-hand air scoop cover.

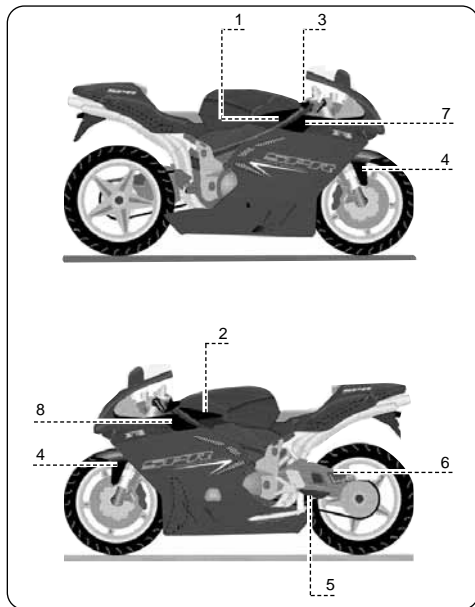



8.4. Accessories

MV Agusta, through **MV AGUSTA Special parts**, has designed a wide range of accessories, kit and special parts to customize or increase the performances of your motorcycle. This way, **MV Agusta** provides you the chance to develop your motorcycle, taking advantage of the excellence and the exclusiveness of innovatory technical solutions with the quality warranty provided by CRC technical department of research and development. Both frame and bodywork spare parts designed by Cagiva Research Center for MV Agusta Special Parts have undergone severe tests and rigorous checks, in order to offer to the Customers the same official warranty as all MV Agusta products.

In order to request these components or consult the MV Agusta Special Parts Catalogue, we suggest to refer to:



MV Agusta Special Parts S.r.l. - Sales and Technical Assistance Service
Via Ovella 41 - 47893 Borgo Maggiore - Republic of San Marino (R.S.M.)
Phone number: (00378) 0549 907.749 - Fax number: (00378) 0549 907.746
e-mail: info@mvagusta-sp.com - <http://www.mvagusta-sp.com>

MV Agusta strongly recommends not to use non-genuine components, since they cannot offer the same safety, vehicle performance and life duration as original and certified spare parts.



8.5. Clothing

MV AGUSTA Special Parts has designed a wide range of wear products and accessories providing high aesthetical and qualitative standards, helping to strenghten and consolidate the prestige of the MV Agusta trademark and, at the same time, making an exclusive experience out of riding an already unique vehicle.





NOTES

A series of horizontal dotted lines for writing notes.



NOTES

A series of horizontal dotted lines for writing notes.



NOTES

.....

.....

.....

.....

.....

.....

.....

.....

.....

.....

.....

.....

.....

.....

.....

.....

.....

.....

.....

.....

.....

.....



NOTES

A series of horizontal dotted lines for writing notes, spanning the width of the page.



NOTES

A series of horizontal dotted lines for taking notes.

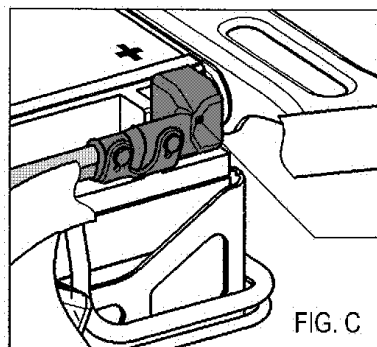
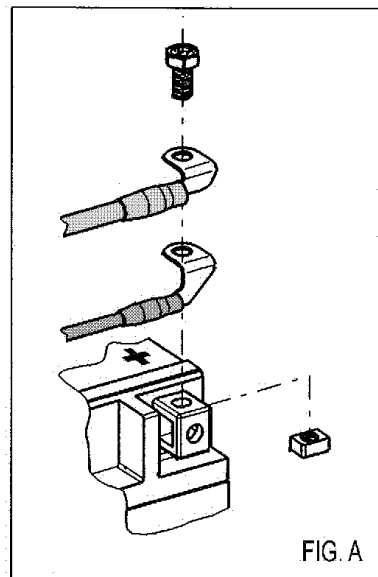

CAP

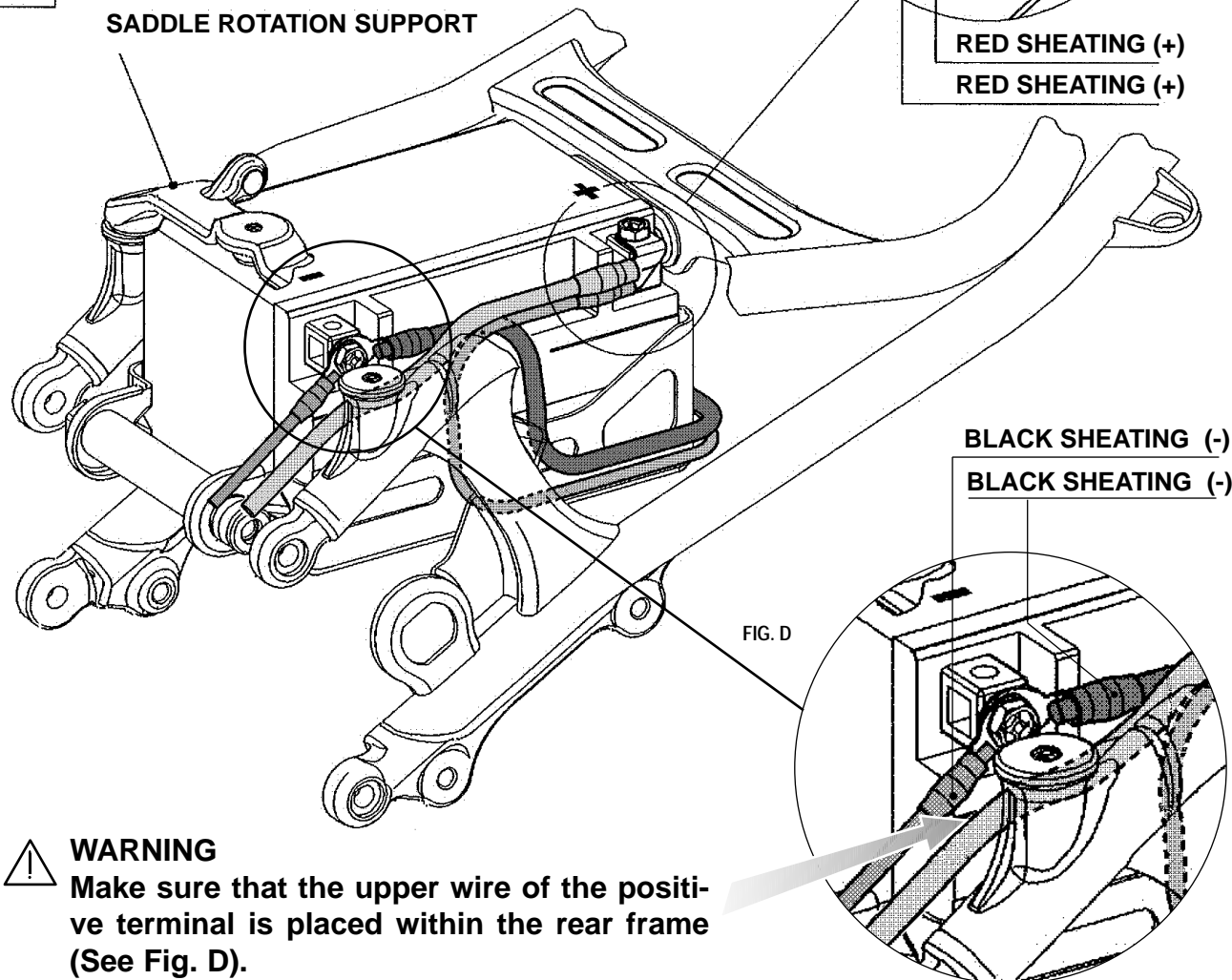
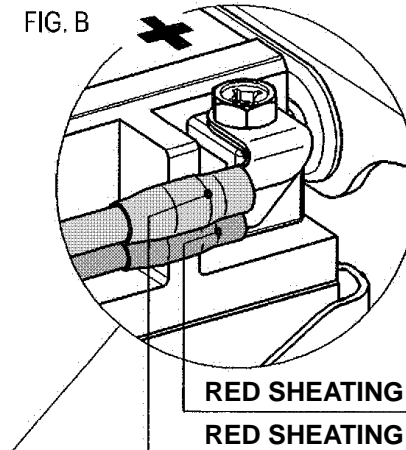

Terminals (wire terminals) positioning and fitting on the battery.

- Fit the 2 positive terminals (+) on the relevant battery pole, as shown in **Fig. A** and **Fig. B**. Tighten the screw at torque **7÷8 Nm**.
- Afterwards, fit the **cap** on the positive pole (**Fig. C**).
- Fit the 2 negative terminals (-) on the relevant battery pole (**Fig. D**). Tighten the screw at torque **7÷8 Nm**.
- The battery connection cables must pass under the **saddle rotation support**.



WARNING

Make sure that the upper wire of the positive terminal is placed within the rear frame (See Fig. D).

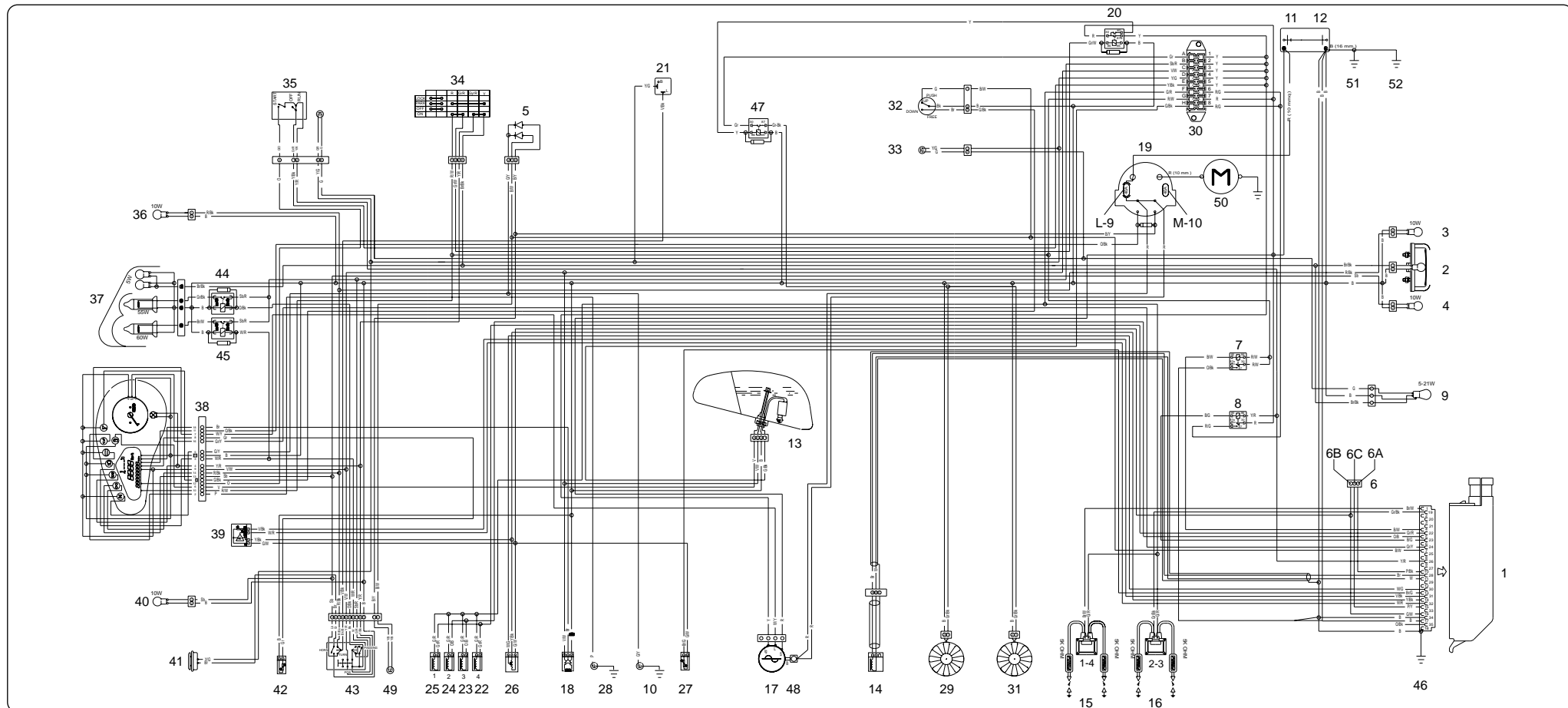

Ref.	Description
1	Power unit
2	Plate light
3	Turn indicator, right hand
4	Turn indicator, left hand
5	Starter power unit
6	Diagnosis connector (6A-Serial line RX, 6B-Ground, 6C-Serial line TX)
7	LATCH relay
8	Power relay
9	Brake light
10	Neutral switch
11-12	Battery
13	Pump - Low fuel probe
14	Engine rpm sensor
15	Coil
16	Coil
17	Alternator

Ref.	Description
18	Speed sensor
19	Solenoid starter
20	Main relay
21	Intermittence
22-23	Injectors
24-25	Injectors
26	Throttle potentiometer
27	Water temperature sensor for power unit
28	Oil switch
29	Heater fan
30	Fuses
31	Heater fan
32	Side stand switch
33	Rear brake switch
34	Key switch
35	Safety and front brake switch
36	Turn indicator, right hand

Ref.	Description
37	Front light
38	Display
39	Air pressure/temperature sensor
40	Turn indicator, left hand
41	Horn
42	Water temperature sensor for display thermometer
43	Light switch
44	Low beam relay
45	High beam relay
46	Frame-power unit ground
47	Heater fan relay
48	Battery recharge
49	Clutch switch
50	Starter
51	Frame ground
52	Engine ground

Wire colors list	
Letter(s)	Color
R	Red
Y	Yellow
B	Blue
G	Green
W	White
Bk	Black
P	Pink
V	Violet
Sb	Sky blue
Gr	Grey
O	Orange
Br	Brown

In combined colors, background and marking colors have been pointed out. E.g. : Br/Bk.

Fuses list		
Ref.	Amperage (A)	Application
A-1	15	Heater fans
B-2	15	Low and high beams
C-3	7.5	Parking lights - Odometer sensor - Low fuel probe
D-4	7.5	Stop light - Horn - Turn indicator lights
E-5	7.5	Starter engagement / disengagement switch - Starter button
F-6	15	Coils - Injectors
G-7	7.5	LATCH relay - Main relay - Display
H-8	15	Fuel pump
L-9	40	Battery recharge
M-10	40	Battery recharge supply

In order to highlight the racing attitude of the F4 SPR motorcycle, MV Agusta has defined a special range of setup adjustments for every owner who uses his vehicle in a specially competitive way.

In fact, it is possible to vary the driving characteristics of your motorcycle by changing the geometrical heights of the components on its rear part. This way, it is possible to improve the control response and the handling of the vehicle.

WARNING! This operation must be performed only by a MV Agusta authorized dealer.

To correctly perform this operation, use the following tools:

- Rear stand part code no. 800092642
- Rear suspension setting rod part code no. 800093347

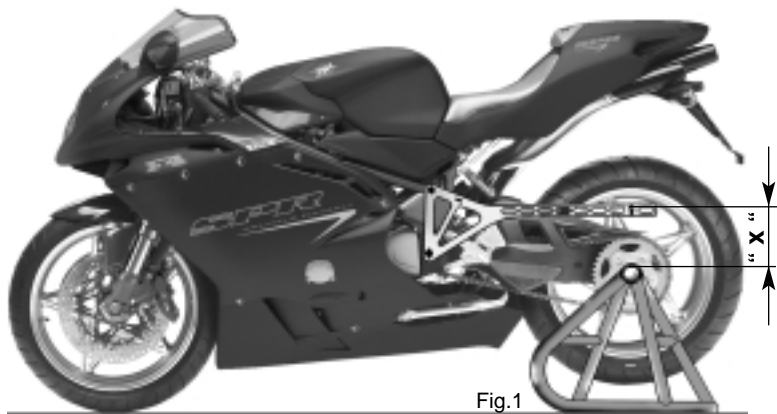

Fig.1

Place the vehicle on the rear stand and insert the rear suspension setting rod in its proper seats (see Fig. 1).

The "X" dimension highlights the geometrical height by means of which it is possible to change the setup adjustment.

This dimension, as you can see in Fig. 2 and 3, is equal to **194 mm** in the standard conditions.

If you want to modify the driving characteristics of your vehicle, you can increase the "X" dimension up to the maximum value (**200 mm**).

As the "X" dimension increases, your motorcycle gains a better handling and a faster control response during riding.

WARNING! Do not increase the X dimension over 200 mm.

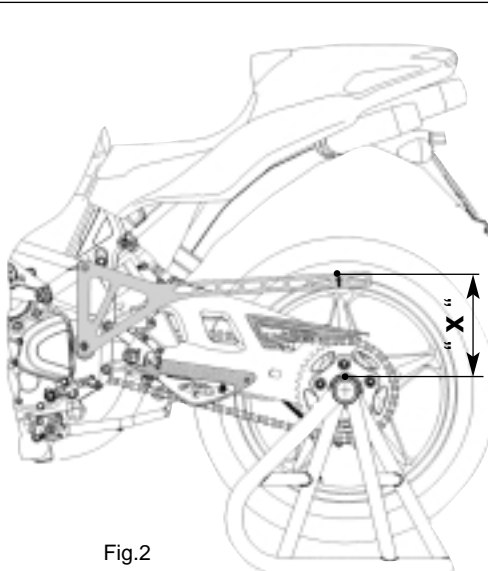

Fig.2

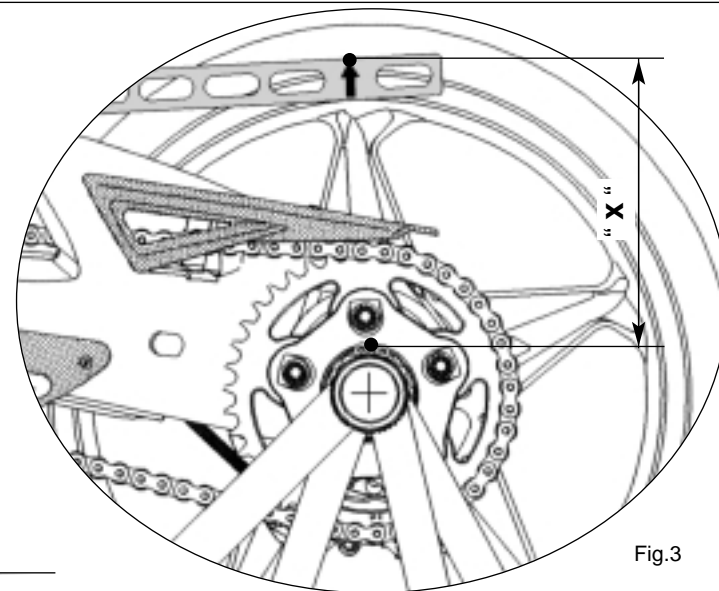

Fig.3

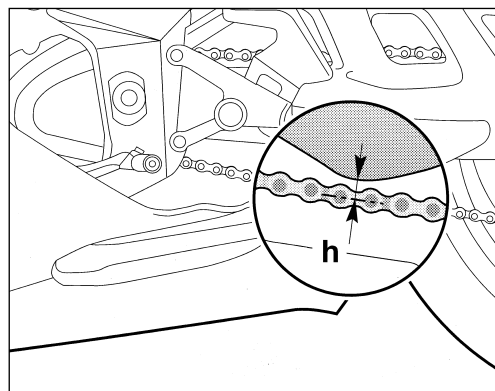

Fig.4

After the completion of the vehicle's new setup adjustment operation, it is **necessary** to restore the correct drive chain adjustment.

The "h" dimension must be measured according to the procedure shown in Fig. 4. Its value must be adjusted according to the setup and the dimensions of the rear sprocket.

WARNING! Pay particular care and attention when performing the drive chain adjustment. An incorrect drive chain adjustment can lead to damage to the vehicle, with subsequent dangerous situations for the rider.

The table below shows the several values which the "h" dimension must be equal to, according to the setup and the dimensions of the rear sprocket.

		Number of teeth on the rear sprocket		
		Z = 37	Z = 38	Z = 39
X Values	190	h = 0	h = 2	h = 4
	192	h = 1	h = 3	h = 5
	194 <small>Standard geometry</small>	h = 2	h = 4	h = 6
	196	h = 3	h = 5	h = 7
	198	h = 4	h = 6	h = 8
	200	h = 5	h = 7	h = 9

N.B. The values of the "h" dimension refer to a vehicle with a Z 15 front sprocket and a genuine MV Agusta drive chain.

SPR



MV AGUSTA S.p.A. - Technical Assistance Service
Via Nino Bixio, 8 - 21024 Cassinetta di Biandronno (VA)
ITALY - Tel. ++ 39 0332 254.111 Fax ++ 39 0332 756.509
www.mvagusta.it Part No. 8A00A0960 Edition No.1